



Installation Guide / Montageanleitung
Montagevejledning

Protecting Box / Tragekasten
Beskyttelseskasse



3
3 Jahre Garantie
3 års garanti
3 years warranty

GB · D · DK

A

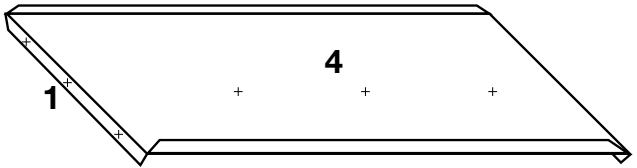
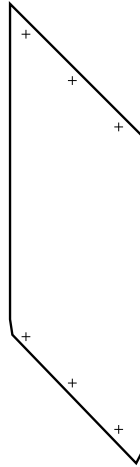
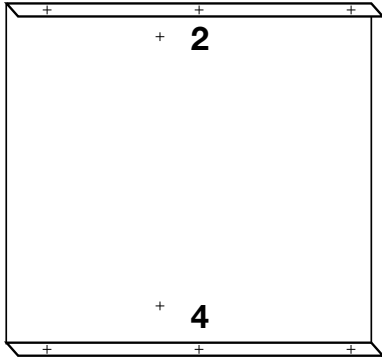
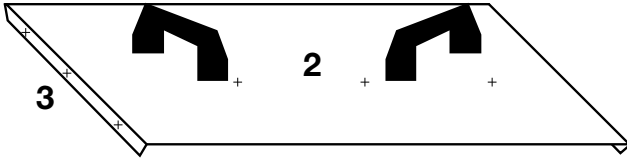

B

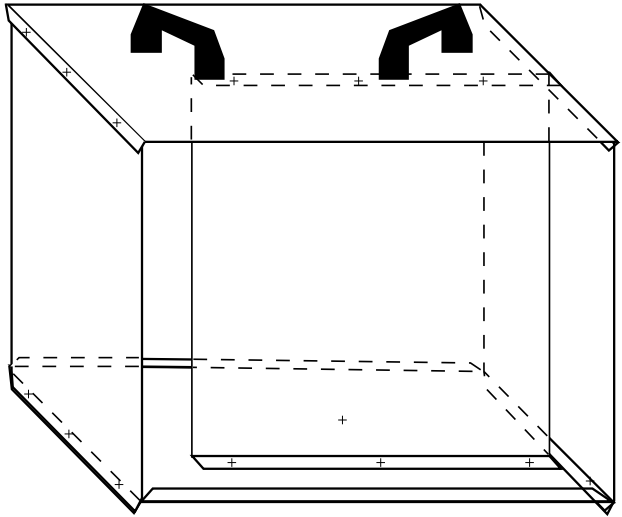

C

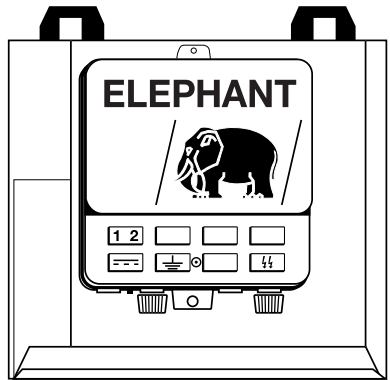
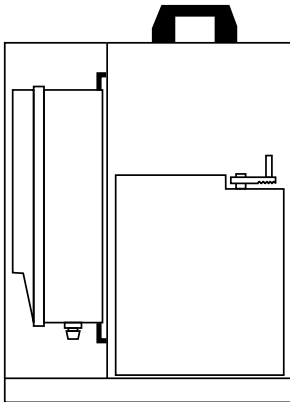

KOHSEL ELEKTRONIK A/S
Holbladsvej 17
DK-8600 Silkeborg
Denmark
Tel. +45 8682 4427
Fax +45 8682 4426
web www.elephant.as