

EN User manual

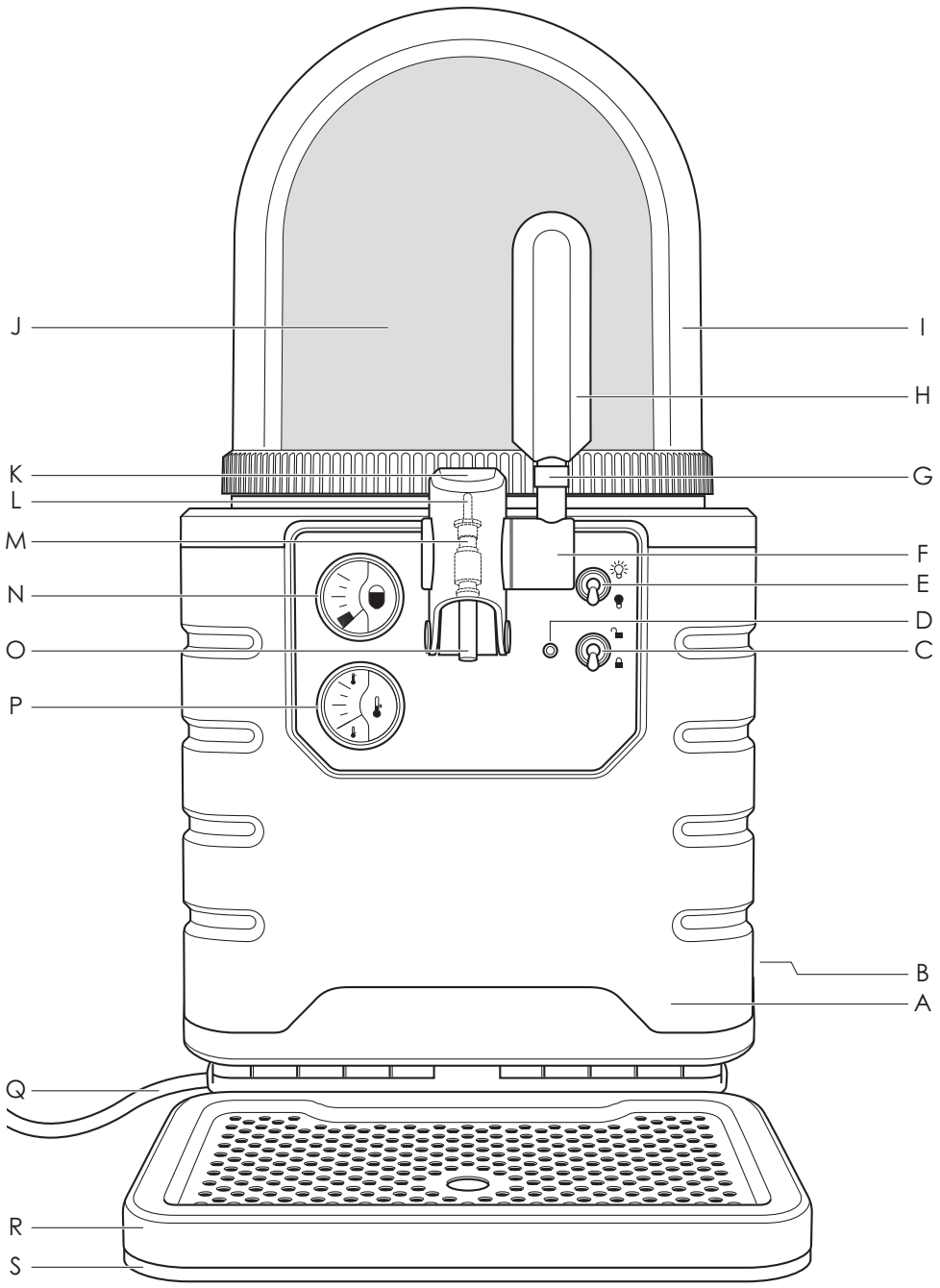

BLADE[®]
BREWLOCK[®] COUNTERTOP
DRAUGHT SYSTEM



Dear customer,

congratulations with the purchase of your Blade® countertop draught system appliance for Blade® disposable beer kegs, you have chosen a quality product in line with the latest standards of technology and functionality.

Please read the information contained in this user manual to familiarise yourself quickly with the appliance and be able to make full use of its functions.

Your appliance will serve your needs for many years to come provided you handle and maintain it with due care.

We wish you a lot of pleasure with your Blade® countertop draught system.

Appliance

Appliance-/operating elements

- A) Main appliance
- B) Main switch
- C) Keg locking switch
- D) Keg locking indicator light
- E) Dome lighting switch
- F) Dispense tap
- G) Tap handle shaft
- H) Tap handle
- I) Dome
- J) Disposable beer keg
- K) Tap cover
- L) Beer tube
- M) Inline dispensing valve
- N) Volume gauge
- O) Beer spout
- P) Temperature gauge
- Q) Power cord
- R) Stainless steel drip tray cover
- S) Drip tray base

Scope of delivery

- Blade® countertop draught system appliance for Blade® disposable beer kegs
- Transparent dome
- Tap handle shaft
- Tap handle
- Tool for mounting the tap handle shaft
- Removable drip tray with stainless steel drip tray cover
- User manual

WIK - Elektrogeräte
Entwicklungs- und Service GmbH & Co. KG
Schacht Neu-Cöln 12
D-45355 Essen
Germany

Table of contents

1	Safety	5
1.1	Danger of electric current	5
1.2	Fundamental safety precautions.....	6
1.3	Consumer information	7
2	General	8
2.1	Information on this user manual	8
2.2	Intellectual property rights	8
2.3	Warnings	8
2.4	Intended use	9
2.5	Reasonably foreseeable misuse	9
2.6	Limitation of liability	9
2.7	Customer service.....	9
3	Putting into operation	10
3.1	Preparing for use	10
3.2	Requirements for place of operation	10
3.3	Electrical installation.....	11
3.4	Set-up and assembly of the appliance	11
3.5	Connecting the Blade® appliance to the power supply ...	12
3.6	Mounting the drip tray	12
3.7	Preparing the keg	13
3.8	Inserting the keg into the appliance and connecting it ...	13
3.9	Switching on the appliance	15
4	Operation and use	16
4.1	Displays	16
4.2	Indicator light	17
4.3	Switches	18
4.4	Optimum dispensing	18
4.5	Removing or replacing the empty keg.....	19
4.6	Handling partially empty kegs	20
4.7	Removal partially empty kegs	20
4.8	Switching off the appliance.....	20
5	Cleaning and maintenance	21
5.1	Safety precautions	21
5.2	Regular cleaning	22
5.3	Cleaning the bowl.....	22
5.4	Cleaning the condenser.....	22
6	Troubleshooting	23
6.1	Safety precautions	23
6.2	Proper packing of the appliance.....	23
6.3	Trouble, possible causes and remedies.....	24
7	Storage	25
8	Disposal of the Blade® appliance	25
8.1	Disposal of the packing	25
9	Appendix	26
9.1	Technical data	26
9.2	Warranty	27

1 Safety

This section contains important safety instructions for handling Blade® countertop draught system appliance. This appliance complies with the prescribed safety regulations. Improper use can however result in personal injury and/or appliance damage.

1.1 Danger of electric current!

Danger to life by electric current! Contact with live wires or components could lead to serious injury or even death!

Observe the following safety precautions to avoid electric shocks:

- ▶ If the supply cord is damaged, it must be replaced by a special cord or assembly available from the manufacturer or its service agent!
- ▶ Do not open the housing of the appliance. Danger of electric shock if live connections are touched and/or the electrical and mechanical configuration is changed.
- ▶ The voltage of the power source must be the same as specified on the rating plate!
- ▶ Before use check that the appliance functions properly!
The appliance should not be used if:
 - the power cord is damaged
 - the appliance shows noticeable damage
 - the appliance has been dropped
- ▶ Connect the appliance only to AC current and to a socket with earthing contact. Do not pull the cord over sharp edges, clamp it into place or allow it to hang down! Keep the cord away from hot and damp areas!
- ▶ Only insert the mains plug when the appliance is switched off!
- ▶ The appliance must not be operated with a timer nor a remote control system. If an extension lead is required, use only an earthed cord with a conductor cross-section of at least 1.5 mm²!
- ▶ Do not use this appliance near bathtubs, showers, basins or other vessels containing water. 
- ▶ If the appliance falls into water, remove the mains plug immediately. Under no circumstances reach into the water when the appliance is still connected to the power supply!
- ▶ Do not place the appliance or the power cord on hot surfaces e.g. cooker or similar or in the vicinity of open flames!
- ▶ The installation of a faulty current protective appliance with a rated breaking current offers you additional safety by ensuring that 30 mA will not be exceeded in the house installation. Let your installation electrician advise you!

- ▶ This appliance incorporates an earth connection for functional purposes only.
- ▶ If the appliance does not function properly and before cleaning remove the plug from the mains.
- ▶ Protect the appliance against climatic influences such as damp or direct sunlight. The appliance is not approved for use outdoors.

1.2 Fundamental safety precautions

Observe the following safety information for safe handling of the appliance in order to prevent material damage and/or personal injury:

- ▶ This appliance complies with the recognized rules of technology and the pertinent safety regulations for electrical appliances!
- ▶ Inspect the appliance for visible signs of damage before use. Do not use a damaged appliance.
- ▶ Repairs to the appliance must only be carried out by a trained technician or authorized person. Unqualified repairs can lead to considerable danger for the user. They will also void the warranty.
- ▶ Only trained and certified technicians should service this appliance. The appliance is only to be installed in locations where its use and maintenance is restricted to trained personnel.
- ▶ Defective parts may only be replaced with original spare parts. Only original spare parts guarantee that the safety requirements are met.
- ▶ Do not use mechanical devices or other means to accelerate the defrosting process, other than those recommended by the manufacturer.
- ▶ Do not use electrical appliances inside the cooling area of the appliance.
- ▶ Do not store explosive substances such as aerosol cans with a flammable propellant in this appliance.
- ▶ This appliance is not intended for use by persons (including children) with reduced physical, sensory or mental capabilities or lack of experience and knowledge. Children should be supervised to ensure that they do not play with the appliance.
- ▶ Children must not play with the appliance.
- ▶ Children should not clean or perform maintenance procedures on the appliance unless they are supervised by a responsible adult.
- ▶ This appliance is intended to be used in commercial applications such as:
 - by professional staff in commercial environments
 - bars and restaurants
 - by clients in hotels, motels and other residential type environments
 - bed and breakfast type of environments
- ▶ Always use the appliance for the appropriate purpose!
- ▶ Never immerse the appliance itself, the mains cord or the mains plug into water or other liquids.

- ▶ Do not lift the appliance by the tap handle.
- ▶ Do not clean the appliance or accessories in a dish washer.
- ▶ Do not use a water jet for cleaning. The appliance is not suitable for installation in an area where a water jet could be used.
- ▶ You can clean your appliance with a slightly damp cloth and dry it with a soft dry cloth.
- ▶ Do not use sharp or abrasive cleaning agents.
- ▶ Only operate the appliance when the drip tray and the drip tray cover are fitted.
- ▶ The appliance has to be placed in a horizontal position. Do not place the machine in direct sunlight or near a source of heat or under rain.
- ▶ In order to assume a fault-free operation, the ambient temperature should be between 10°C and 38°C with a maximum rH of 75%
- ▶ After unpacking the appliance or in case of plug changing or appliance tilting, wait for 8 hours before turning the appliance on.
- ▶ Do not pull the cord to remove the plug from the mains socket or touch it with wet hands.

Observe the following safety information for safe handling of the disposable keg in order to prevent material damage and/or personal injury:

- ▶ Ensure that there are no signs of any external damage on the keg. A damaged seal cannot be fitted correctly and may lead to damage or an uncontrolled dispense of beer.
- ▶ Do not expose the keg to extreme temperatures and NEVER store the keg in direct sunlight or in a freezer. Non-compliance will lead to material damage or personal injury.
- ▶ Do NOT shake the keg. The keg has a slight overpressure. Please handle it with care!
- ▶ Pay attention to the best before date.
- ▶ Do not insert a keg into the appliance if it has already been opened or tapped. A keg that has been inserted and opened must remain in the appliance – which must itself remain switched on – until it has been used up or until the maximum useful life of 30 days has expired.

1.3 Consumer information

- ▶ Before the keg is inserted into the appliance, it should first be pre-cooled for at least 16-24 hours in a refrigerator or cold storage with a max temperature of 4 degr. C.
- ▶ If a keg is inserted into the appliance without having been pre-cooled in advance, this leads to significantly longer cooling times until the 3 degr. C drinking temperature is reached.
- ▶ It is best to store unopened kegs at a constant cool temperature in a cold storage.

2 General

2.1 Information on this user manual

This user manual is a component of the Blade® countertop draught system (subsequently referred to as the 'appliance') for Blade® disposable beer kegs and features important information concerning start-up, safety, intended use and appliance maintenance.

The user manual must be kept close to the system at all times. It must be read and observed by every person entrusted with operating, troubleshooting and cleaning of the appliance. You can download the user manual for your appliance from the follow website:

www.blade.shop.

2.2 Intellectual property rights

This document is protected by copyright.

Any duplication or reprinting, in whole or in part, and the reproduction of the illustrations even in modified form is only permitted with the written approval of the manufacturer. Blade® is a registered trademark in Europe and other countries.

2.3 Warnings

The following warnings are used in this user manual:

DANGER

A warning of this category indicates a potentially dangerous situation.

If the dangerous situation is not avoided, it may lead to serious injury or even fatal injury. (e.g., electric shock).

- ▶ It is therefore imperative that you follow the instructions in this warning in order to avoid personal injury.

WARNING

A warning of this category indicates a potentially dangerous situation.

If the dangerous situation is not avoided, it may lead to injuries (e.g., burns).

- ▶ Follow the instructions in the warning to prevent injuries.

CAUTION

A warning of this category indicates potential material damage.

If the situation is not avoided, it may lead to material damage (e.g. defective appliance).

- ▶ Follow the instructions in the warning to prevent damage.

NOTE

- ▶ A note indicates additional information that simplifies the use of the appliance.

2.4 Intended use

The appliance must only be used as a Blade® countertop draught system for Blade® disposable beer kegs and is intended EXCLUSIVELY for commercial indoor use.

Any use other than previously stated is considered as improper use.

⚠ WARNING

Danger resulting from improper use!

If not used for its intended purpose or used in any other way, the appliance may be or become a source of danger.

► Observe the procedures described in this user manual.

No claims of any kind will be accepted for damage or injury resulting from use of the Blade® countertop draught system appliance for other than its intended purpose. The risk has to be borne solely by the appliance owner.

2.5 Reasonably foreseeable misuse

- The appliance must not be operated with third-party products.
- The appliance must not be operated with defective or opened Blade® disposable beer kegs.

2.6 Limitation of liability

All technical information, data and instructions on installation, operation and maintenance of the appliance contained in these operating instructions represent the current status and are based on the best possible knowledge gained by experience and know-how. No claims can be derived from the information, illustrations and descriptions in this user manual.

The manufacturer assumes no liability for damage or injury resulting from failure to observe the user manual, use for other than the intended purpose, unprofessional repairs, unauthorised modifications or use of non-approved spare parts.

2.7 Customer service

For initial contact in the event of questions, complaints or repairs we have set up a service hotline for you.

You will find the service hotline number for your country on the website: www.blade.shop.

Experience has shown majority of all complaints on Blade® countertop draught system appliances from customers are attributed to operating errors. Please take the opportunity to obtain quick and easy assistance from our service hotline.

Call the service hotline and save yourself the hassle of transporting your appliance to your retailer. The service hotline also provides information on the warranty process.

Please note that the appliance can only be transported safely in the original packaging. If the appliance is not packed correctly, the customer must bear the liability for any damage caused during transport. You should therefore keep the original packaging. Information on how to correctly pack the appliance can be found in Chapter **6.2 Proper packing of the appliance**.

Putting into operation

3 Putting into operation

3.1 Preparing for use

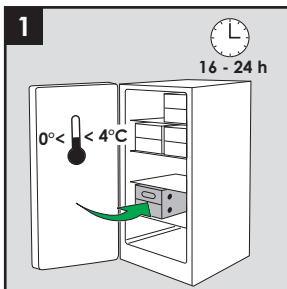

The appliance is not designed to cool down kegs. Therefore please make sure that the kegs are pre-cooled in a refrigerator or cold room for at least 16 - 24 hours before use (Figure 1). Please therefore ensure that the required kegs are stored in corresponding cooling units or cold stores in good time prior to use.

NOTE

- ▶ Only genuine disposable kegs made by Blade® can be used. This guarantees the consistent quality of the beer.

3.2 Requirements for place of operation

For safe and trouble free operation of the appliance it must be placed on a location that suits the following conditions:

- Place the appliance on a fixed horizontal, heat resistant and water-resistant surface that is strong enough to hold it. Distance to rear wall at least 5 cm (Figure 2).
- The power plug must be easily accessible after the appliance is installed and can be easily pulled out in case of emergency.
- In order to assume a fault-free operation, the ambient temperature should be between 10° C and 38° C with a maximum rH of 75%.

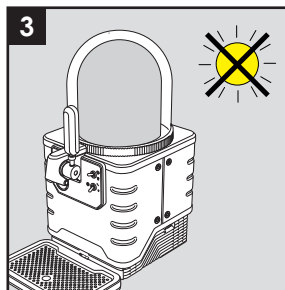
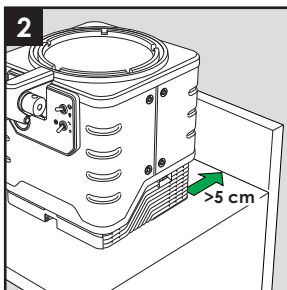

NOTE

- ▶ To eliminate the risk of the appliance or the keg overheating, the appliance must never be exposed to direct sunlight during operation (Figure 3).

3.3 Electrical installation

For safe and trouble-free operation of the Blade® countertop dispense appliance, the following instructions on electrical connection must be observed:

- Before connecting the Blade® countertop draught system appliance, compare the connection data (voltage and frequency) on the rating plate with those of your mains power supply. This data must correspond in order to avoid damage to the appliance. If in doubt, consult a qualified electrician.
- The socket must be secured at least 10A fuse or higher (Max. 16 A). Ensure that the power cord is undamaged and is not laid over hot surfaces or sharp edges.
- The power cord must not be pulled tight.
- The electrical safety of the appliance is only assured when it is connected to a properly installed protective earth (PE) conductor system. Connection to a mains socket without PE conductor is forbidden. If in doubt, the electrical system must be checked by a qualified electrician. The manufacturer assumes no liability for injury or damage caused by a missing or interrupted protective earth conductor.
- The appliance can be damaged in situations where the electrical grid (i.e. the network delivering electricity to outlets) is unreliable and of poor quality. In case the electrical grid is not delivering the required power quality a voltage stabilizer must be installed.

3.4 Set-up and assembly of the appliance

- Place the appliance on a stable tabletop or counter.

CAUTION

- ▶ The appliance can be lifted by the tap but not on the tap handle.

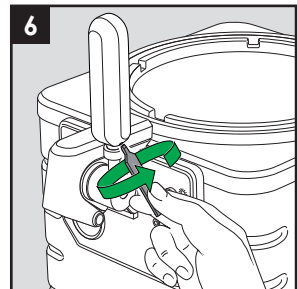
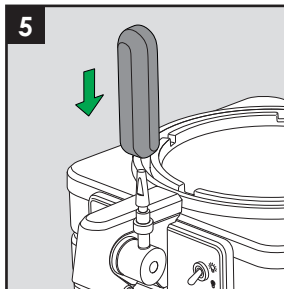
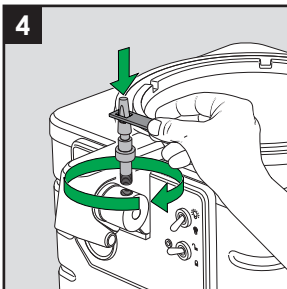

- Screw the tap handle shaft into the thread of the turning mechanism located on the right of the dispense tap and pull tight using the spanner provided (Figure 4).
- Now push the tap handle onto the rod as far as it will go. Align the tap handle with the front of the appliance (Figure 5).
- Using the screwdriver located on the tool, the grub screw on the underside of the handle is screwed into the handle such that it can no longer be rotated (Figure 6).

NOTE

- ▶ Ensure that the tap handle cannot be removed after assembly.

Putting into operation

3.5 Connecting the appliance to the power supply

The appliance is now connected to the power supply as follows:

- Tilt the appliance around 30° to the right and feed the appliance side of the power cord into the socket located on the underside of the appliance (Figure 7+8).

NOTE

- ▶ Appliance is already pre-connected with a power cord.

CAUTION

- ▶ Ensure that this plug connection is secure.
- ▶ The base of the appliance must not be placed on top of the cord, as this would make it impossible to guarantee the secure positioning of the appliance.
- ▶ **After unpacking the appliance or in case of plug changing or appliance filling, wait for 8 hours before turning the appliance on** (Figure 9).

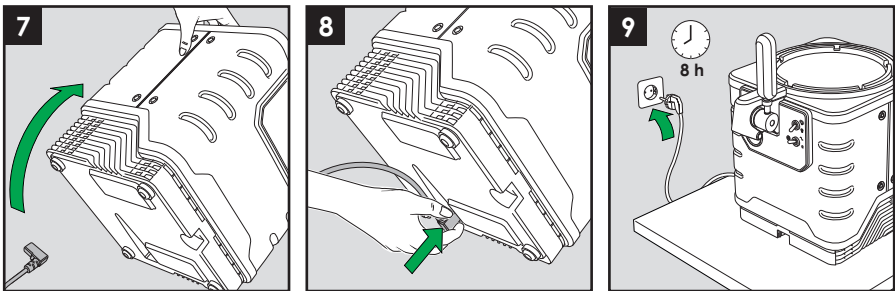

- Now connect the power cord to the power supply. (See 3.3 Electrical Installation).

3.6 Mounting the drip tray

- Position the drip tray base (S) with the drip tray cover (R) centrally in front of the appliance. Then push it gently forwards until it engages in the operating position (Figure 10+11).

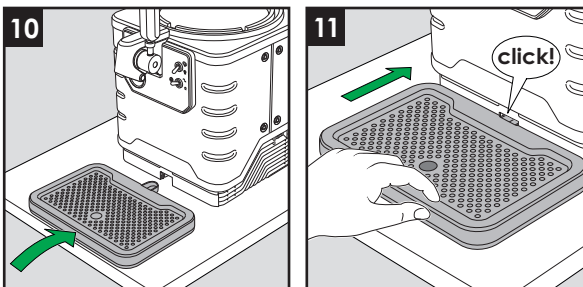

NOTE

- ▶ Perform this assembly step prior to connecting the keg, as a certain amount of beer may escape in the subsequent process.

3.7 Preparing the keg

The keg must now be prepared for connection. Please perform the following steps:

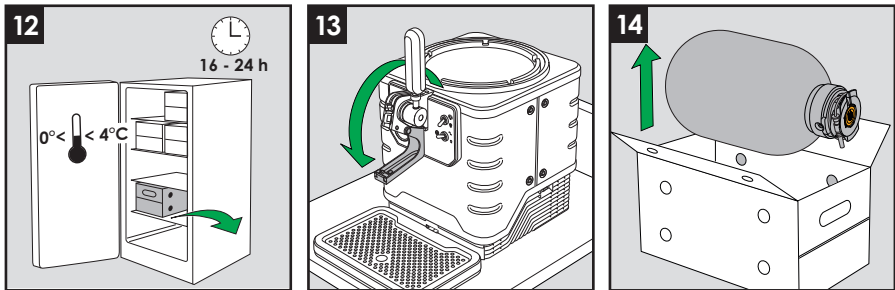

- Use only pre-cooled kegs stored in a refrigerator or cold room (Figure 12).
- Flip down the tap cover (**K**) (Figure 13).
- Remove the pre-cooled keg (**J**) from the packaging (Figure 14).

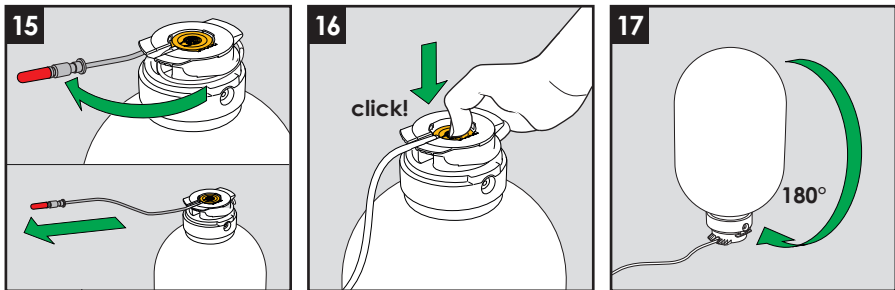

- Fully unwind the beer tube (**L**) with inline dispensing valve (**M**) of the keg (**J**) (Figure 15).
- Use your thumb to press the orange button into the retainer of the keg until you hear an audible click. Only once this step has been performed the keg is ready to be tapped (Figure 16).
- Flip the keg upside down (Figure 17).

Putting into operation

3.8 Inserting the keg into the appliance and connecting it

The pre-cooled keg is now ready to be inserted into the appliance. Proceed as follows:

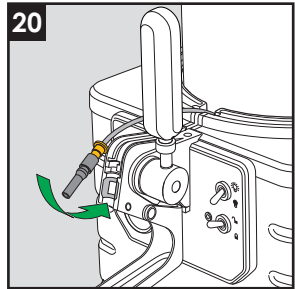
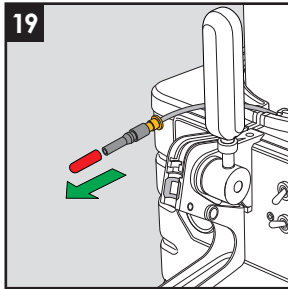
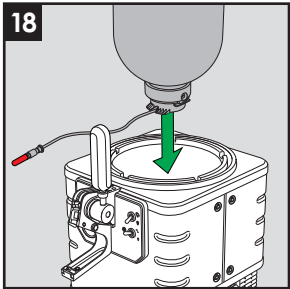

- Carefully guide the keg into the cooling bowl, making sure to keep it vertical. The beer tube (**L**) must point exactly in the direction of the dispense tap and it must be easy to insert into the retainer groove (Figure 18).
- Remove the red protection cap from the beer spout (**O**) (Figure 19).
- Bend the beer tube downwards until it is positioned entirely in the retainer groove and the upper orange part of the valve (**M**) can be inserted into the valve retainer (Figure 20).

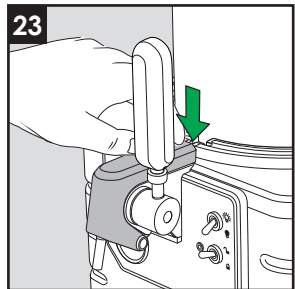
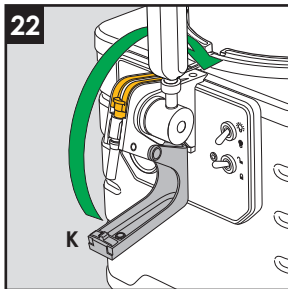
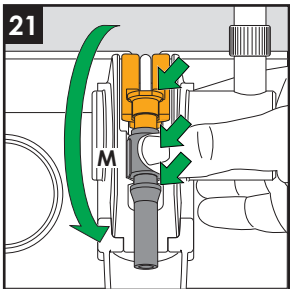

- Now use your thumb to firmly press the lower black part of the valve (**M**) into the metallic valve holder such that the valve is not pressed back out after you let go (Figure 21).
- Flip up the tap cover (**K**) as far as it will go. This cover must remain in the end position after you let go. If the cover springs forwards once again, this indicates that the beer tube or the valve is not positioned correctly (Figure 22+23).

NOTE

- ▶ It is essential to ensure that the in line dispensing valve is securely positioned. If this is not the case, it will still be possible to open the valve with the tap, but the valve will not close again once the tap handle (**H**) is moved upwards. This will lead to an uncontrolled discharge of beer.

3.9 Switching on the appliance

NOTE

► Each time prior to switching on, make sure that the appliance is properly set up and securely connected.

- Place the dome onto the appliance. This also keeps the contents cool and makes it possible to light up the appliance (Figure 24).
- Switch on the appliance by pressing the ON/OFF switch on the right of the appliance (Figure 25).
- Now use the toggle switch **(C)** to set the keg locking to "Close". The indicator light **(D)** next to this will flash green till the keg is locked. You will hear the locking mechanism of the appliance and then see the indicator light change to a continuous green light (Figure 26+35).

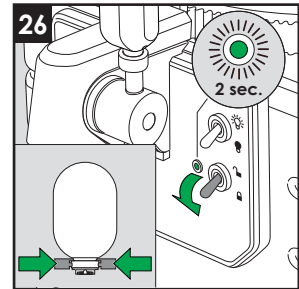
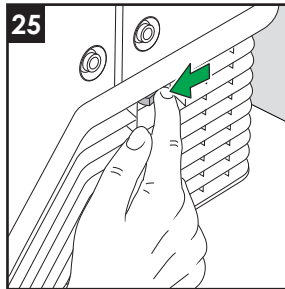
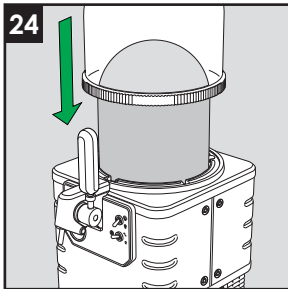

The keg is now locked and the pump audibly generates positive pressure in the keg. Once the pump switches off after around 30 seconds, the beer is cooled actively. The cooling fan is the only thing that can now be heard.

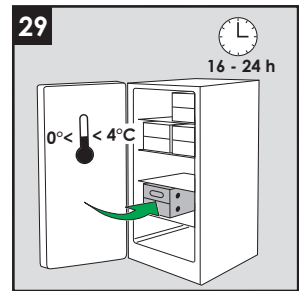
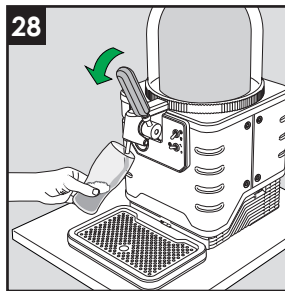
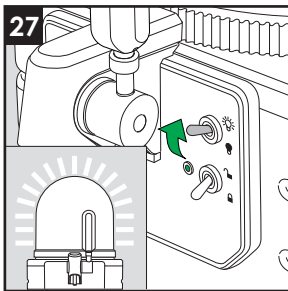

- The appliance is ready for use. You also have the option of activating the toggle switch for the dome lighting **(E)** in order to switch on the effect lighting ☼ (Figure 27).
- Dispense a small amount of beer to test that the appliance is functioning correctly (Figure 28).
- Make sure there are enough pre-cooled kegs in your cold storage (Figure 29).

4 Operation and use

4.1 Displays

The front of the appliance features 2 indicator instruments:

- The volume gauge (**N**) is automatically set to full when a new keg is installed and indicates the amount of beer remaining. The flow is measured and the indicator changes accordingly (Figure 30+31).

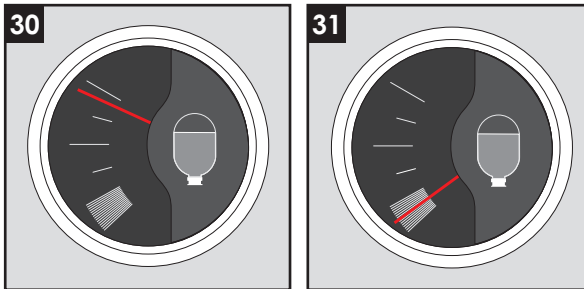

Almost full

Almost empty



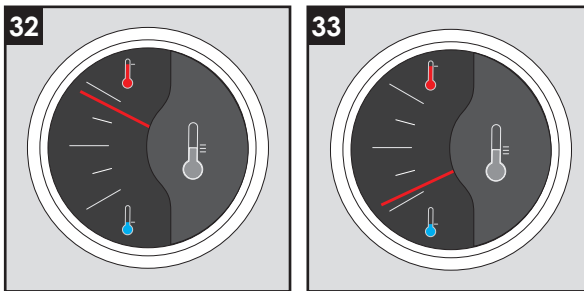





- The temperature gauge (**P**) uses a sensor to indicate the temperature of the beer (Figure 32+33).



Temperature too high

Optimum drinking temperature

4.2 Indicator light

LED signal	Display	Status
LED OFF		<ul style="list-style-type: none"> ■ Kege locking switch is in upper position, no disposable beer keg is locked. Idle state (normal status).
Green blinking		<ul style="list-style-type: none"> ■ Kege locking switch is down and the locking box is moving to the close position to connect the air nozzle.(normal status).
Green ON		<ul style="list-style-type: none"> ■ Disposable beer keg is detected, locking box is closed (normal status).
Red blinking		<ul style="list-style-type: none"> ■ Kege locking switch is down, locking box is open again because the disposable beer keg was not detected. ■ After the Kege locking switch is back in upper position the LED will be OFF. Back in idle state (see LED OFF).
Red blinking for 2 seconds		<ul style="list-style-type: none"> ■ If the kege is empty and the kege locking switch is switched in upper position. The red LED blink for 2sec before the locking box starts to move in open position to remove the kege. (Normal use).
Red blinking for 10 seconds		<ul style="list-style-type: none"> ■ If the kege is not empty and the kege locking switch is switched in upper position. The red LED blink for 10sec before the locking box starts to move in open position to remove the kege. (Normal use).
Red ON		<ul style="list-style-type: none"> ■ Direct after a disposable beer keg was insert, locking box closed, kege was detected, but it was not possible to increase pressure (bad air connection). ■ The locking box was automatically open (abnormal status).
Red/green alternated blinking		<ul style="list-style-type: none"> ■ During usual running of the appliance, not anymore possible to increase air pressure (abnormal status).

4.3 Switches

There are three toggle switches on the appliance.

- The main switch **(B)** on the right of the appliance (Figure 34).
- The keg locking switch **(C)** with indicator light **(D)** on the control panel (Figure 35).
- The dome lighting switch **(E)** for the effect lighting on the control panel (Figure 35).

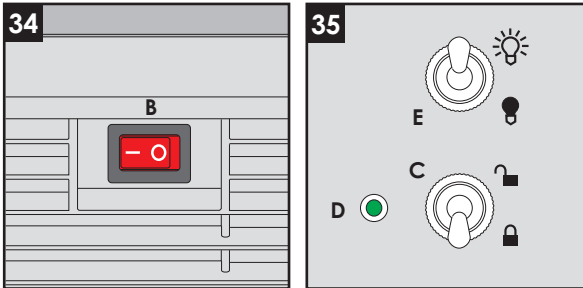

4.4 Optimum dispensing

To ensure optimum dispensing, perform the following steps:

NOTE

- ▶ Use glasses that are clean, cool and rinsed with fresh water.

- When dispensing, avoid the spout touching the beer or foam in order to prevent residues affecting the quality of the head.
- Fully open the tap in one continuous movement, otherwise too much foam will form in the glass.
- Dispense the beer and close the tap when glass is full. **CHEERS!**

NOTE

- ▶ Rinse out the glasses with fresh cold water before using them again. This ensures a longer-lasting head and prevents the formation of excess foam.

The volume gauge is set to full when a new keg is installed and indicates the amount of beer remaining. The flow time is measured via a microswitch and the corresponding amount is deducted from the full volume.

4.5 Removing or replacing the empty keg

NOTE

- ▶ The keg is empty in case the beer flow stops while the tap is open.
- ▶ If dome light is on when keg will unlock the light brightness will be reduced as long as the new keg is locked or dome light will be switched off.

When removing the empty keg, perform the following working steps:

- Disconnect the keg from the appliance by turning the switch **(C)** upwards to set the keg locking to "Unlock" (🔓) (Figure 35). The indicator light **(D)** flashes red for around 2 seconds (10 seconds if the keg is not empty) and the locking mechanism audibly move backwards (Figure 36).
- Remove the dome **(I)** (Figure 37).
- Flip down the tap cover **(K)** (Figure 38).

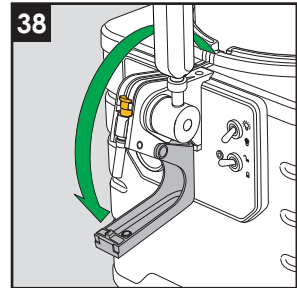
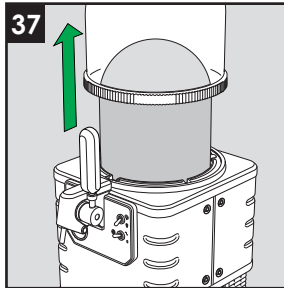
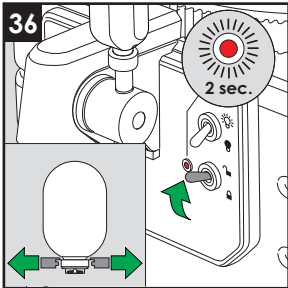

- Remove the inline dispensing valve **(M)** from the holder of the dispense tap **(F)** and remove the beer tube **(L)** from the retainer (Figure 39).
- Now remove the keg (Figure 40).

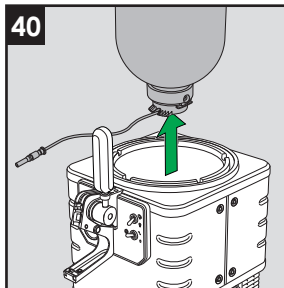
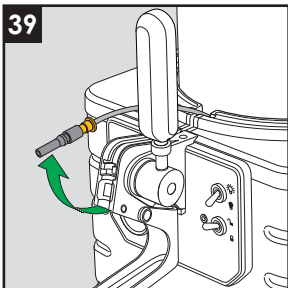

NOTE

- ▶ Dispose of the empty container in an environmentally-friendly manner.

4.6 Handling partially empty kegs

Partially empty kegs must not be unlocked and must remain in the appliance – which must itself remain switched on – to ensure that the correct pressure and cooling is maintained. Once a keg has been opened, the correct internal pressure and cooling must be maintained in order to prevent an escape of carbon dioxide that would impair the taste of the beer and increase the formation of foam when dispensing.

4.7 Removal partially empty kegs

NOTE

- ▶ Avoid the unlocking of a keg which is still partly full unless you want to change it.

When removing the partly empty keg, perform the following working steps:

- Disconnect the keg from the appliance by turning the switch **(C)** upwards to set the keg locking to "Unlock" (🔓). The indicator light **(D)** flashes red for around 10 seconds and the locking mechanism audibly move backwards (Figure 41).

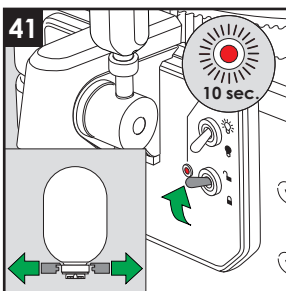

- Follow the instructions described in chapter 4.5 Removing or replacing the empty keg.

NOTE

- ▶ Be careful when you remove the inline dispensing valve **(M)** from the holder of the dispense tap **(F)**. The partially empty keg has a slight overpressure. An open dispensing valve will lead to an uncontrolled discharge of beer. Please handle it with care!

4.8 Switching off the appliance

When no keg is installed and the switch **(C)** is locked (🔒) the indicator light **(D)** flashes red (Figure 42).

- Turn the switch **(C)** upwards to set the keg locking to "Unlock" (🔓) (Figure 43).
- Switch off the empty appliance without a keg using the ON/OFF switch **(B)** on the right of the appliance (Figure 44).

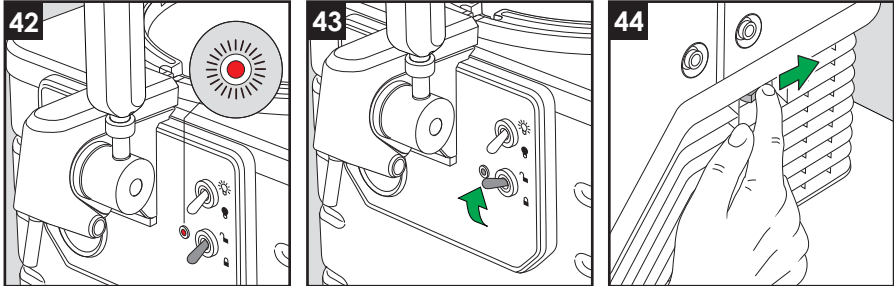

NOTE

- ▶ If there is no keg in the appliance, the keg unlocking switch (C) must always be in the open position.

5 Cleaning and maintenance

This section contains important information on cleaning and maintenance of the appliance.

The special design of the Blade® disposable kegs ensures that the appliance does not come into contact with the beer. This significantly reduces the amount of cleaning and maintenance required. However, you should always ensure that your appliance is clean in order to ensure hygienic and problem-free use.

CAUTION

Damage due to the effect of heat and aggressive cleaning agents.

All removable parts, such as the tap handle, drip tray and dome of the appliance, are not dishwasher-safe.

- ▶ Clean the appliance according to the instructions as described in this section.

5.1 Safety precautions

⚠ DANGER

Observe the following safety precautions before starting to clean the Blade® countertop draught system appliance:

- ▶ Switch off the appliance and pull the plug out of the mains socket before starting cleaning.
- ▶ Never immerse the appliance itself, the power cord or the mains plug into water or other liquids.

CAUTION

- ▶ Do not use any scratching, abrasive or corrosive agents. Wipe the housing with a soft damp cloth.
- ▶ Do not use a water jet for cleaning.
- ▶ Do not clean housing parts such as the dome or the drip tray in the dishwasher. Otherwise, the high-gloss surfaces will gradually become dull and matt.
- ▶ Observe the cleaning instructions.

5.2 Regular cleaning

- Clean the outer surfaces of the appliance with a soft damp cloth, the indicator instruments can be cleaned e.g. with a lens cleaning cloth.
- Remove the dome (**I**) and clean it with warm water and a mild washing-up liquid. Wipe the inner side with a damp cloth.
- Empty the drip tray (**S**) at regular intervals.
- Clean the drip tray and the stainless steel drip tray cover (**R**) with warm water and a mild washing-up liquid.

5.3 Cleaning the bowl

- Inside bowl must be regular cleaned with a max 100 ml warm water and a mild washing-up liquid. Wipe the inner side dry and check if the drain line is unblocked.

5.4 Cleaning the condenser

- Clean the ventilation openings with a vacuum cleaner (not battery-operated) (Figure 45).

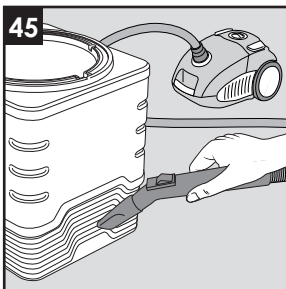

NOTE

- ▶ The ventilation openings of the condenser must be cleaned every 3 months or when necessary.

6 Troubleshooting

This section contains important information on localising and eliminating faults. Please observe the notes to prevent danger and damage.

6.1 Safety precautions

⚠ DANGER

Danger from electric current!

Danger to life in event of contact with live cables or components!

- ▶ Pull the mains plug out of the socket before beginning with troubleshooting.

⚠ WARNING

Danger from unqualified repairs!

Observe the following safety precautions to avoid danger and material damage:

- ▶ Do not open the appliance. Repairs to electrical appliances may only be carried out by qualified electricians. Unqualified repairs can lead to considerable danger for the user and cause serious damage to the appliance.

6.2 Proper packing of the appliance

In the event of a warranty claim, pack the Blade® countertop draught system appliance into the original carton using the original packing material as shown at pictures on original packaging and proceed as follows:

- Remove the tap handle and the tap handle shaft.
- Empty the drip tray base (S). Clean the appliance and all parts.
- Pack the appliance and the drip tray each into a plastic bag (Figure 46).

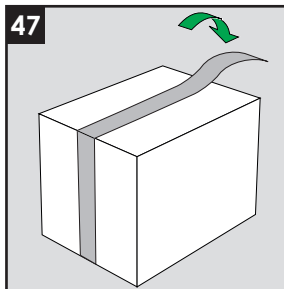
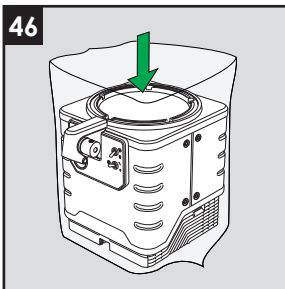

- Finally seal the carton with adhesive tape (Figure 47)!

NOTE

- ▶ Original carton packaging can be obtained from the local distributor.

Troubleshooting

6.3 Trouble, possible causes and remedies

Problem	Cause	Remedy
The cooling fan is still running although the keg has been unlocked.	<ul style="list-style-type: none"> ■ The interior of the machine must be kept cool after switching off. 	<ul style="list-style-type: none"> ■ The fan runs for an extra minute after the cooling is switched off.
The keg has been unlocked but cannot be removed.	<ul style="list-style-type: none"> ■ There might be frost in the system. 	<ul style="list-style-type: none"> ■ Relock the keg and unlock it again. ■ In the appliance is a heating element which heat up the cooling element to defrost. This takes several minutes. Please try to remove after 15 minutes. ■ Switch it back on and try to unlock the keg again. If this is unsuccessful, have the appliance inspected by customer service.
	<ul style="list-style-type: none"> ■ Unlocking does not function. 	<ul style="list-style-type: none"> ■ Switch it back on and try to unlock the keg again. If this is unsuccessful, have the appliance inspected by customer service.
The temperature gauge shows the beer is cold but after a few glasses the beer is warm.	<ul style="list-style-type: none"> ■ The keg has probably not been pre-cooled long enough. 	<ul style="list-style-type: none"> ■ If you leave the keg for at least 24 hours in the Blade® appliance the entire keg will be cooled and the problem will be solved. ■ If this is unsuccessful, have the appliance inspected by customer service.
The keg light is blinking red.	<ul style="list-style-type: none"> ■ The keg locking switch is down while there is no keg in the appliance or the keg is not properly detected. 	<ul style="list-style-type: none"> ■ Flip the switch up and (re)load a keg. The light will blink for a few seconds and then go to green. ■ If the light remains blinking repeat these steps until you get the continuous green light.
The volume gauge says the keg is full while many beers have been tapped from it.	<ul style="list-style-type: none"> ■ Probably the keg has been unlocked and locked again during use. 	<ul style="list-style-type: none"> ■ This has reset the volume counter to full. The problem will be solved after loading a full keg.

7 Storage

If you do not intend to use the Blade® countertop draught system appliance for a prolonged period, clean it as described in section **5 Cleaning and maintenance** in order to prevent mold from building up. Mould is harmful to health. Store the appliance and all accessory parts in a dry, clean and frost-free place which is protected against direct sunlight.

8 Disposal of the appliance



This symbol on the product, the operating instructions or the packaging indicate that this product must not be disposed of as normal household refuse after the end of its service life. Dispose of the appliance in accordance with the EC Directive 2012/19/EC (Waste Electrical and Electronic Equipment). Should you have any questions, please contact the local authority responsible for waste disposal.

The materials can be recycled in accordance with their markings. Proper recycling and disposal of the appliance and its materials after the end of its service life makes a major contribution to the protection of our environment.

NOTE

- ▶ Use the collection point at your place of residence to return and recycle old electrical appliances. Ask your local authority where the responsible disposal point is located.
- ▶ Make the appliance unserviceable before disposal. Keep your old appliance away from children until it is collected.

8.1 Disposal of the packaging

Returning the packaging to the material cycle saves raw materials and reduces the amount of waste generated. When no longer required, dispose of the packaging materials in accordance with the local regulations.



The packaging protects the appliance against damage during transit. The packaging materials have been selected according to environmental and waste disposal aspects and can therefore be recycled.

NOTE

- ▶ The packaging protects the appliance against transport damage. Keep the original packaging of the appliance as long as necessary so that it can be correctly and securely packed in case repairs are required.

9 Appendix

9.1 Technical data

Designation	Beer Dispensing System
Order No.	9930
Operating voltage	See rating plate on your appliance
Power consumption	See rating plate on your appliance
Max. operating pressure	2,4 ± 0,4 bar
Power cord	2 m (can be removed)
Protection class	I
Complete dimensions	590 mm x 290 mm x 471mm (H x W x D)
Weight without keg	approx. 17.6 kg
Weight with keg	< 26 kg
Flow volume	1.6 l/min
Dispensing speed	≤ 9 seconds for 250 ml
Keg volume	8 litres
Sound pressure level (LpA)	< 70 dB(A)
Working pressure	1.3 - 1.5 bar
Coolant (type and quantity)	R600A; 12 g
Climate class	SN-ST
Max. operating temperature	38°C 75% RH
I.P. rating	For indoor use only (IPX0)

Interference suppression: This appliance is interference-suppressed in accordance with the interference suppression directives.

CE compliance:

This product complies with the Low Voltage directive 2014/35/EU, the machinery directive 2006/42/EU and the EMC directive 2014/30/EU.

9.2 Warranty

A warranty is granted for the Blade® countertop draught system appliances in accordance with the statutory provisions of the country in which the appliance was purchased.

This applies to all faults caused by material or manufacturing defects.

This warranty does not cover:

- Parts subject to wear such as seals and valves.
- Damage caused by failure to comply with the required cleaning intervals.
- Damage caused by the use of other cleaning solutions than those recommended by the manufacturer.
- Appliances not used for the intended purpose or not put into operation as stated in the operating instructions.
- Appliances opened and/or manipulated by unauthorised persons.

For replacement or repair of damaged parts that are excluded of warranty please contact Blade® Customer service.

The warranty period begins with the original date of purchase. Claims can only be made under warranty if the original invoice or proof of purchase is submitted with the defective Blade® countertop draught system appliances.

Claims made under warranty do not prolong the statutory warranty period.

**WIK - Elektrogeräte
Entwicklungs- und Service GmbH & Co. KG
Schacht Neu-Cöln 12
D-45355 Essen
Germany**