

montage instructies

aanbevolen gereedschap:



Nr.13

meubel:

tafel

artikel:

Olger

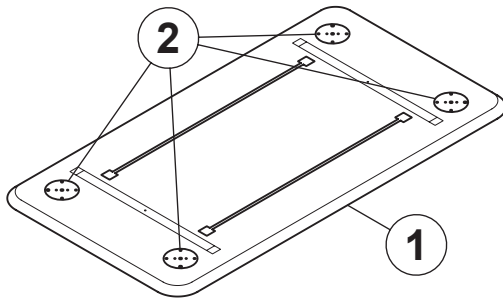

1x

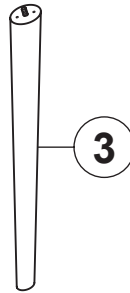

4x

A

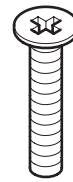

Ø 4,5/40

B



M 8

4x

C



8x

M 6/20

16x

1

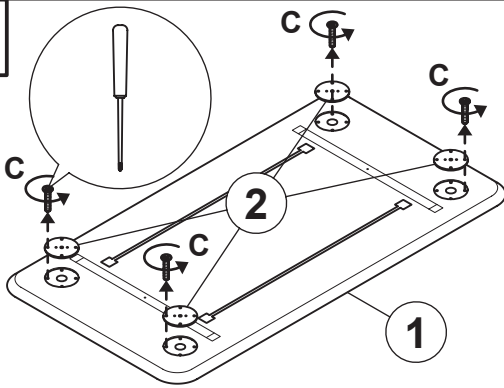

3

Tafels met een lengte van meer dan 200 cm zijn uitgerust met een spanningsregelaar/trekstang. Door spanning toe te voegen of af te nemen kan het tafelblad uitgelijnd worden.

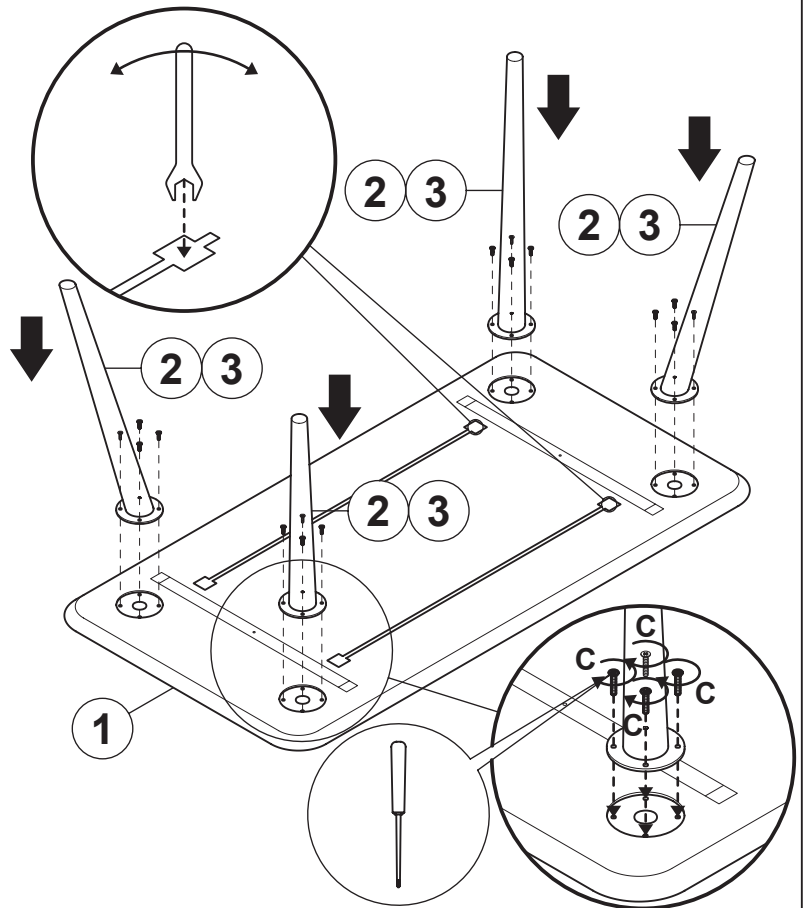

2

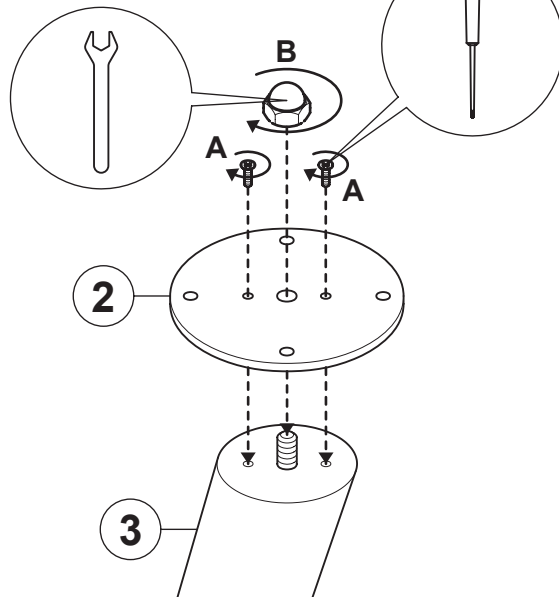

4

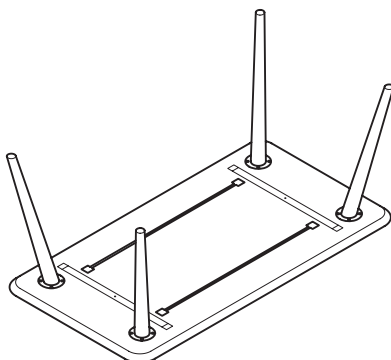

5

