



AKRON

RANGE OF PATIENT POSITIONING COUCHES AND PLINTHS

Technical Information

STREAMLINE™ 225



All **STREAMLINE™** products have a Safe Working Load of 225 kgs and have been tested to the applicable clauses within IEC 60601-2-38 for mechanical safety and load test.

All products are tested in accordance with IEC 60601-2-38 Clause 28.4.

This symbol denotes the Safe Working Load of the couch and its capability to lift the specified load from the minimum to the maximum height. In addition, all **STREAMLINE™** couches have been rigorously tested, with a 2 x Safe Working Load (450kg) loaded evenly, for in excess of one hour, to further prove lifting capability.



The **Contourline™** comfort upholstery feature has been developed to provide enhanced patient comfort and security. The subtle contoured shaping increases patient contact areas, improving comfort, as well as positioning the patient centrally upon the couch. Available on standard models (64cm) at additional cost.



AKRON's Quality Management System is certified by Lloyd's Register Quality Assurance (LRQA) to ISO9001:2008 and ISO 13485:2003 as identified by certificate number LRQ 4002740.



The CE marked products comply with the Essential Requirements in Annex I of EC Directive 93/42/EEC and the technical documentation is detailed within the 'Technical File'.



All Akron products featured in this catalogue have been designed to provide clearance for a mobile hoist for patient transfer procedures.

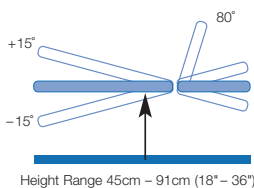

All height range measurements are from floor to top surface working height and have a tolerance of +/- 1.5cm. All angular measurements have a tolerance of +/- 5 degrees.

All upholstery sizes are for each individual section do not include hinges and have a tolerance of +/- 1.5cm. Overall lengths may be longer.



The upholstered couch sections satisfies flammability requirements to the following standards. BS7176:1995 (medium hazard) using ignition sources 0 (cigarette), 1 (gas) as defined in BS EN. 1921-1 & 2 and 5 (crib) BS.5852:1990

Standard Colours – Mundial Range

The Mundial Contract Vinyl is suitable for a wide range of healthcare applications. The surface is hard wearing, water proof, easy to clean and is available in 6 standard colours.

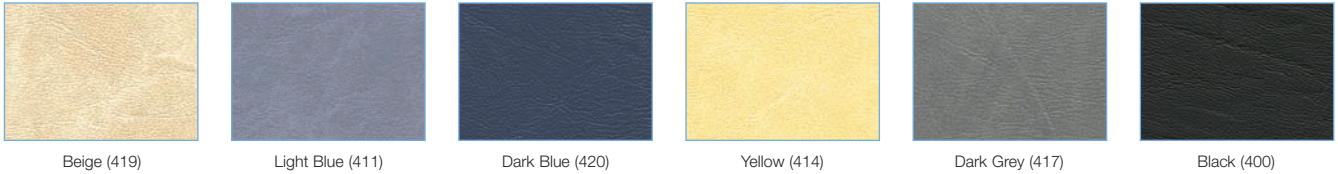

Premium Colours – Diabolo Range (Additional Cost)

The Diabolo Club Contract Vinyl is very hard wearing and suitable for a wide range of hospital and nursing home furniture, rehabilitation equipment and care home product applications. This high quality range of vinyls is available at an additional cost. There is a choice of 12 colours.

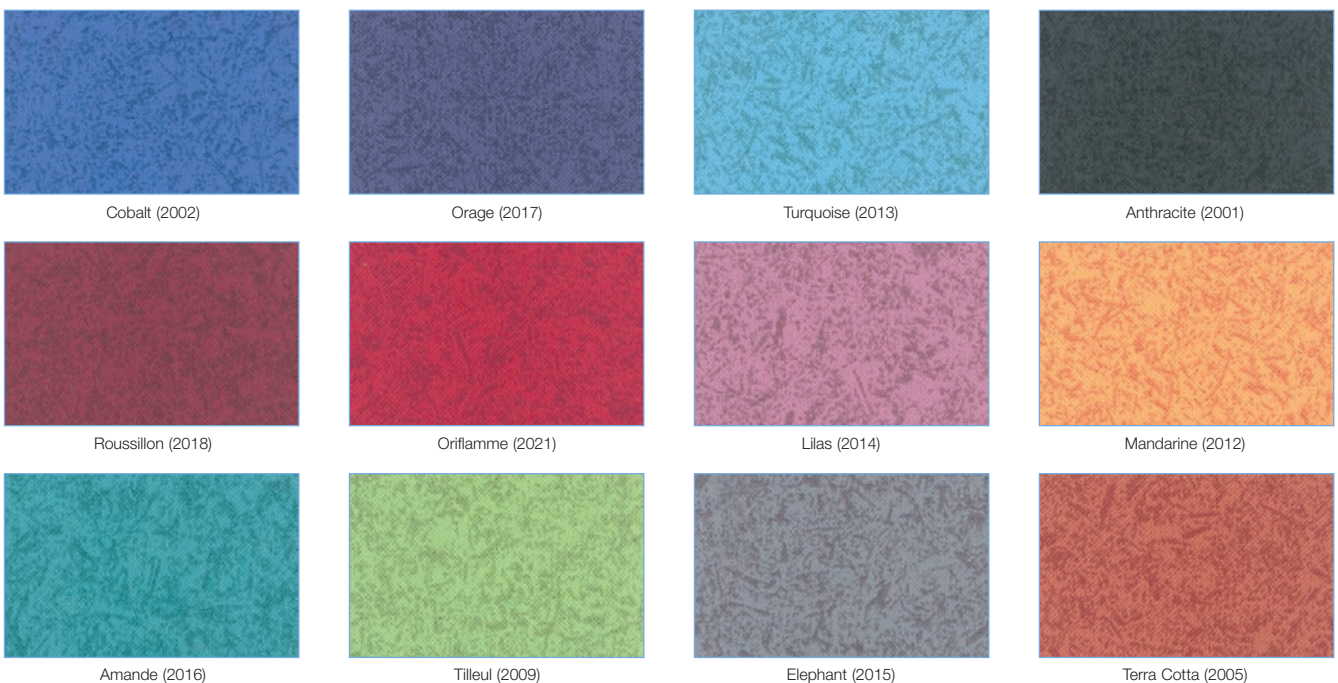

	Mundial Contract Vinyl	Diabolo Club Contract Vinyl
Waterproof capability	Water column 4	Water column 6
PVC/cotton content	88% PVC – 12% cotton	84% PVC – 16% cotton
Martindale rub test	38,000 rubs without wear	50,000 rubs without wear
Surface finish	Embossed leather look	Anti-slip smooth surface
Resistant to mildew and body sweat	Yes – when cleaned regularly	Yes – when cleaned regularly

Full details of cleaning and decontamination of all vinyls are detailed within the user manual. Please note: The colours illustrated may vary from actual vinyl supplied. This is because these colours are emulated using four colour printing process. However, every attempt has been made to make them as accurate as possible.

Contourline™ Upholstery Option

Available as a cost option on all **STREAMLINE™** Models (except Drop End).

This option can only be supplied at 64 and 70cm widths.

HCOU111	Contourline™ Upholstery (additional cost per couch)	£95.00
HCOU112	Premium Diabolo Vinyl colour (additional cost per couch)	£29.00
HCOU113	70cm Width option (additional cost per couch)	£56.00
HCOU114	80cm Width option (additional cost per couch)	£112.00



AKRON

STREAMLINE™ Popular

A very strong and rigid couch designed to withstand constant heavy use with minimal maintenance. Available with a choice of optional widths and accessories to suit different treatment and examination requirements.

Features

- Safe working load of 225kgs
- Extremely strong and rigid
- Choice of hydraulic or electric height operation
- Retractable wheel base (RWB)
- Positive and negative head section angles
- Mobile hoist compatible
- Self lubricating bearings
- Standard width 64cm (25")
- Choice of upholstery colours – see page 39

Options

- 70cm or 80cm Width at extra cost
- Choice of Hand or Footswitch operation on Electric models
- **Contourline™** comfort upholstery on standard and 70cm width

Optional accessories – see pages 60–61

- Footbar Switch for height operation
- Fold-down Side Supports (pair)
- Side Support Pads (pair)
- Upholstered Arm Support (includes Fixing Kit)
- Paper Roll Holder
- Moulded Base Shroud
- Moulded Arm Support (requires Fixing Kit)
- IV pole (requires Fixing Kit)



HCOU2222A
Colour – Yellow

HCOU2221A	Popular – Hydraulic with RWB	£759.00
HCOU2222A	Popular – Electric with RWB	£759.00



STREAMLINE™ 225

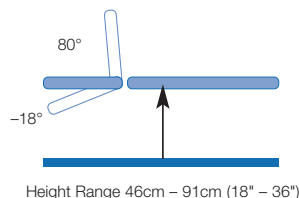

64cm (25") 124cm (49")



AKRON

STREAMLINE™ Continental

Very strong and versatile, suitable for a wide range of manual therapy techniques, various medical procedures, osteopathy, massage and complimentary medicine.



HCOU2231A
 Colour – Amande

Features

- Safe working load of 225kgs
- Extremely strong and rigid
- Choice of hydraulic or electric height operation
- Retractable wheel base (RWB)
- Adjustable angle backrest from horizontal to +80°
- Positive and negative head section angles +80° to -18°
- Mobile hoist compatible
- Self lubricating bearings
- Standard width 64cm (25")
- Choice of upholstery colours – see page 39

Options

- 70cm or 80cm Width at extra cost
- Choice of Hand or Footswitch operation on Electric models
- **Contourline™** comfort upholstery on standard and 70cm width

Optional accessories – see pages 60–61

As for **STREAMLINE™** Popular

HCOU2231A	Continental – Hydraulic with RWB	£815.00
HCOU2232A	Continental – Electric with RWB	£815.00

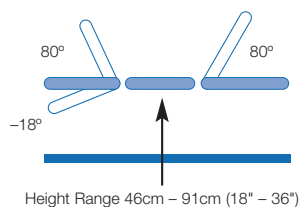
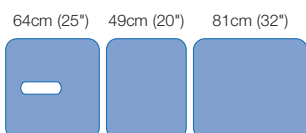

STREAMLINE™ 225





AKRON

Bobath Tables

The Akron Bobath range has been specifically designed for the rehabilitation of patients diagnosed with various neurological conditions. The enhanced rigidity and large upholstered tops allow for the performance of treatment techniques and exercises, with room for both patient and therapists.

Features

- Choice of hydraulic or electric height operation
- Hand or footswitch height control on electric models
- Positive angled head section
- Mobile hoist compatible
- Strong and rigid design
- Choice of widths: 106cm or 124cm (42" or 49")
- Retractable wheel base (RWB)
- Adjustable foot for uneven flooring
- Choice of upholstery colours – see page 39

Options

- Choice of Hand or Footswitch operation on Electric models at no extra cost

Optional accessories – see page 60

- Breathing Hole and Plug



HCOU4412
Colour – Dark Blue



Hand/foot switch

HCOU4411	Bobath Table – Hydraulic height operation (106cm width)	£1,089.00
HCOU4412	Bobath Table – Electric height operation (106cm width)	£1,089.00
HCOU4421	Bobath Table – Hydraulic height operation (124cm width)	£1,175.00
HCOU4422	Bobath Table – Electric height operation (124cm width)	£1,175.00

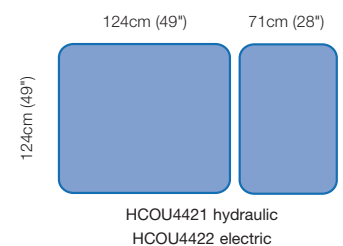
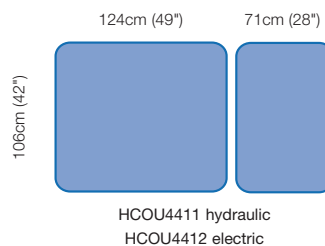
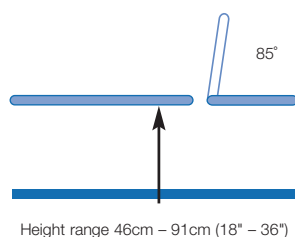

AKRON

Bobath 5

Both the table and specialised accessories were designed with the help and guidance of International Bobath tutors. This product sets the highest standards yet for the treatment and rehabilitation of patients with neurological conditions. The new frame design has an improved working and lifting capacity of 325kgs, providing greater security and safety for both the on board therapist and the heaviest patient.

Features

- Safe working load of 325kgs
- Electrically powered backrest
- Height and backrest operation by handswitch control
- Large wheel base (LWB) with steering facility
- Wide support surface of 106cm
- Backrest adjustable from horizontal to +85°
- Choice of upholstery colours – see page 39



HCOU4632 with optional fold-down side supports
 Colour – Bright Blue (non standard)



HCOU4602



HCOU4603



HCOU4607



HCOU4608

HCOU4632	Bobath 5 – Electric with Electric Backrest with LWB	£1,895.00
HCOU4604	Bobath 5 – Chrome Plated Side Supports (pair)	£187.00
HCOU4605	Bobath 5 – Nylon Coated Side Supports (pair)	£137.00
HCOU1039	Bobath 5 – Side Support Pads (pair)	£101.00
HCOU4602	Bobath 5 – Patient Support Handles (pair)	£62.00
HCOU4603	Bobath 5 – Patient Support Loops (pair)	£62.00
HCOU4607	Bobath 5 – Arm/Leg Support attachment	£225.00
HCOU4608	Bobath 5 – Knee Block/Seat attachment	£185.00

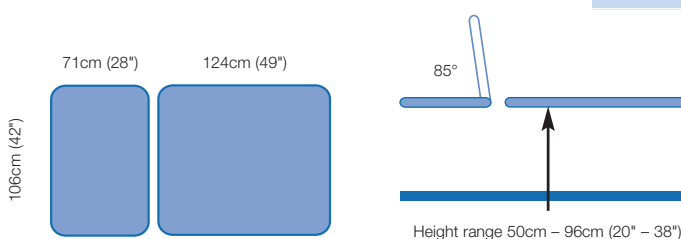



AKRON

De Luxe Tilt Table

The Akron Tilt Table has numerous applications in both examination and treatment procedures. As a product it adds diagnostic value in vascular laboratories, for haemodynamic assessments; in general ultrasound departments, for positional scanning.

Tilt tables are also used extensively in the area of functional rehabilitation for the handicapped and disabled patient where the requirement to stand or be upright is of paramount importance, where it improves the 'quality of life', assists the natural gravitational functions of the body, re-educates the balance mechanisms affected by long periods of lying and gives a degree of independence.

Features

- Electric variable height and tilt operation
- Choice of Standard, Split Leg or Backrest models
- Full 90° of tilt
- Adjustable angle twin foot boards
- Lowers to wheelchair height
- Large braking castors
- Tilt angle indicator
- Hand grips (removable)
- Work table (adjustable and removable)
- Quick release
- Choice of upholstery colours – see page 39

Split Leg models are available with a number of optional accessories that have been developed to cater for patients requiring additional support and stability during Tilt Table procedures. These accessories must be specified at time of ordering.



HCOU8652
Colour – Lilas
(Premium
Diablo Vinyl)



HCOU8652TB Colour – Dark Grey



HCOU8652B Colour – Oriflamme (Premium Diablo Vinyl)



HCOU8606 Quick release as standard



HCOU8652T
Colour – Orange
(Premium Diablo Vinyl)
with optional
accessories fitted



HCOUTT5 Individual knee harnesses

HCOU8652	De Luxe Tilt Table	£1,845.00
HCOU8652T	De Luxe Tilt Table with Split Leg	£1,949.00
HCOU8652B	De Luxe Tilt Table with Backrest	£2,129.00
HCOU8652TB	De Luxe Tilt Table with Split Leg and Backrest	£2,249.00
HCOU8608*	Adjustable Height Child Footboard	£101.00
HCOUTT5*	Individual Knee Harness (pair)	£57.00
HCOU8607*	Adjustable Height Pommel	£74.00
HCOU8610*	Pelvic/Upper Body Supports (pair)	£119.00
HCOUHC-2	Sculptured Head Cushion	£38.00

* Will fit HCOU8652T and HCOU8652TB

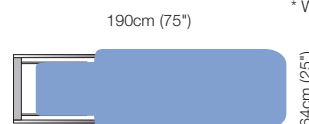
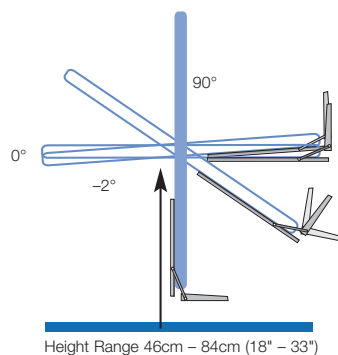

AKRON

STREAMLINE™ Changing Tables

The new **STREAMLINE™** Changing Tables provide a wide choice of models and top sizes to suit individual user requirements. All models have the option of an aesthetically moulded base cover which is easy to clean and disinfect.

Features

- Safe working load 225kgs
- Choice of hydraulic or electric height operation
- Choice of hand or footswitch operation on electric models
- Choice of retractable wheel base (RWB) or large wheel base (LWB) models
- Mobile hoist compatible
- Standard length 152cm (60")
- Standard width 64cm (24")
- Choice of upholstery colours – see page 39

Options

- 183cm (72") Length available at extra cost
- 70cm Width available at extra cost

Optional accessories – see pages 60–61

- Fold-down Side Supports
- Side Support Pads
- Detachable Head Cushion
- Paper Roll Holder
- Moulded Base Shroud



HCOU2211
 with optional side supports
 Colour – Cobalt
 (Premium Diablo Vinyl)



HCOU2312 with optional side support pads,
 shroud and Contourline™ upholstery
 Colour – Mandarin
 (Premium Diablo Vinyl)



HCOU2211	Changing Table – Hydraulic Height with RWB	£695.00
HCOU2212	Changing Table – Electric Height with RWB	£695.00
HCOU2311	Changing Table – Hydraulic with LWB and Side Supports	£925.00
HCOU2312	Changing Table – Electric with LWB and Side Supports	£925.00
HCOU110	183cm Length option (additional cost per couch)	£56.00

HCOU2312 with optional shroud and Contourline™ upholstery
 Colour – Mandarin
 (Premium Diablo Vinyl)

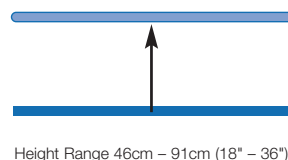
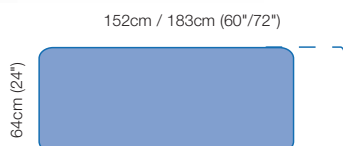



AKRON

STREAMLINE™ Merit 2

Strong and rigid design with a safe working load of 225kgs, this couch addresses the requirements of a wide range of manual handling issues to benefit both patient and clinician.

Features

- Safe working load of 225kgs
- Extremely strong and rigid
- Choice of hydraulic or electric height operation
- Retractable wheel base (RWB)
- Positive and negative backrest angles
- Choice of power assisted or electric backrest operation
- Mobile hoist compatible
- Self lubricating bearings
- Standard width 64cm (25")
- Choice of upholstery colours – see page 39

Options

- 70cm or 80cm Width at extra cost
- Choice of Hand or Footswitch operation on Electric model HCOU2222
- **Contourline™** Comfort Upholstery on standard and 70cm width

Optional accessories – see pages 60–61

- Footbar Switch for height operation
- Fold-down Side Supports (pair)
- Side Support Pads (pair)
- Upholstered Arm Support (includes Fixing Kit)
- Moulded Arm Support (requires Fixing Kit)
- IV Pole (requires Fixing Kit)
- Paper Roll Holder
- Moulded Base Shroud
- Detachable Head Cushion



HCOU2222
Colour – Tileul
(Premium Diablo Vinyl)



HCOU2222
with optional Contourline™ upholstery
Colour – Yellow

HCOU2221	Merit 2 – Hydraulic with RWB and Manual Backrest operation	£729.00
HCOU2222	Merit 2 – Electric with RWB and Manual Backrest operation	£729.00
HCOU2223	Merit 2 – Electric with RWB and Electric Backrest operation	£1,039.00
HCOU7329	Double Footswitch	£93.00



STREAMLINE™ 225

Contourline™
COMFORT UPHOLSTERY

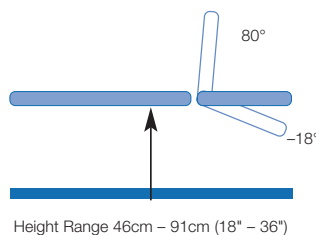

64cm (25")



124cm (49")



64cm (25")

AKRON

STREAMLINE™ Merit 3

This versatile three section couch offers ergonomic solutions to a wide range of clinical and therapeutic procedures.

Features

- Safe working load of 225kgs
- Extremely strong and rigid
- Choice of hydraulic or electric height operation
- Retractable wheel base (RWB)
- Adjustable angle backrest from horizontal to +80°
- Positive and negative foot section angles +80° to -20°
- Mobile hoist compatible
- Self lubricating bearings
- Standard width 64cm (25")
- Choice of upholstery colours – see page 39

Options

- 70cm or 80cm Width at extra cost
- Choice of Hand or Footswitch operation on Electric model HCOU2232
- **Contourline™** Comfort Upholstery on standard and 70cm width

Optional accessories – see pages 60–61

- Footbar Switch for height operation
- Fold-down Side Supports (pair)
- Side Support Pads (pair)
- Upholstered Arm Support (includes Fixing Kit)
- Moulded Arm Support (requires Fixing Kit)
- IV Pole (requires Fixing Kit)
- Paper Roll Holder
- Moulded Base Shroud
- Detachable Head Cushion



HCOU2231
 Colour – Amande
 (Premium Diablo Vinyl)



HCOU2232
 with optional Contourline™ upholstery
 Colour – Lilas
 (Premium Diablo Vinyl)

HCOU2231	Merit 3 – Hydraulic with RWB and Manual Foot/Backrest	£785.00
HCOU2232	Merit 3 – Electric with RWB and Manual Foot/Backrest	£785.00

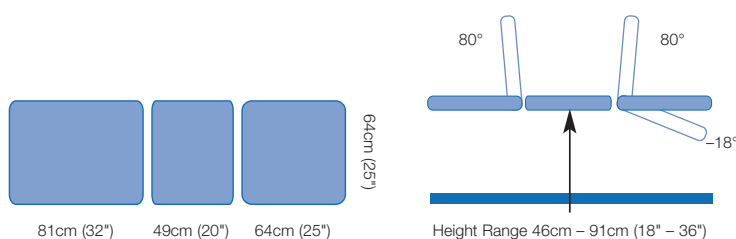

STREAMLINE™ 225

Contourline™
 COMFORT UPHOLSTERY





AKRON

STREAMLINE™ Mobile 2 Section

A choice of three mobile treatment couches fitted with fold-down side supports for patient security and a linked large wheel system with steering facility.

Features

- Safe working load of 225kgs
- Choice of hydraulic or electric models
- Low patient transfer height of 46cm
- Linked large wheel base (LWB) with steering facility
- Mobile hoist compatible
- Fold-down Side Supports (pair)
- Paper Roll Holder
- Self lubricating bearings
- Standard width 64cm (25")
- Choice of upholstery colours – see page 39

Options

- 70cm or 80cm Width at extra cost
- Choice of Hand or Footswitch operation on Electric model HCOU2322 at no extra cost
- Footswitch available on model HCOU2323 at extra cost
- **Contourline™** Comfort Upholstery on standard and 70cm width

Optional accessories – see pages 60–61

- Side Support Pads (pair)
- Upholstered Arm Support (includes Fixing Kit)
- Moulded Arm Support (requires Fixing Kit)
- IV Pole (requires Fixing Kit)
- Moulded Base Shroud



HCOU2323
Colour – Manderine
(Premium Diablo Vinyl)



HCOU2322 with optional
Contourline™ upholstery and shroud
Colour – Orange
(Premium Diablo Vinyl)



Hand/foot switch

HCOU2321	Mobile 2 Section – Hydraulic with LWB and Manual Backrest operation	£999.00
HCOU2322	Mobile 2 Section – Electric with LWB and Manual Backrest operation	£999.00
HCOU2323	Mobile 2 Section – Electric with LWB and Electric Backrest operation	£1,219.00
HCOU7329	Double Footswitch	£93.00



STREAMLINE™ 225

Contourline™
COMFORT UPHOLSTERY

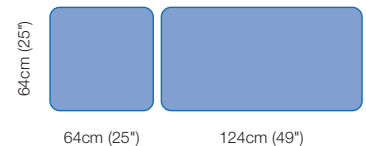
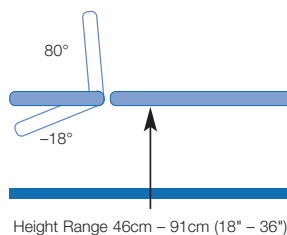

AKRON

STREAMLINE™ Mobile 3 Section

A choice of two mobile treatment couches fitted with fold-down side supports for patient security and a linked large wheel system with steering facility.

Features

- Safe working load of 225kgs
- Choice of hydraulic or electric models
- Low patient transfer height of 46cm
- Linked large wheel base (LWB) with steering facility
- Mobile hoist compatible
- Fold-down Side Supports (pair)
- Paper Roll Holder
- Self lubricating bearings
- Standard width 64cm (25")
- Choice of upholstery colours – see page 39

Options

- 70cm or 80cm Width at extra cost
- Choice of Hand or Footswitch operation on Electric model HCOU2332
- **Contourline™** Comfort Upholstery on standard and 70cm width

Optional accessories – see pages 60–61

- Side Support Pads (pair)
- Upholstered Arm Support (includes Fixing Kit)
- Moulded Arm Support (requires Fixing Kit)
- IV Pole (requires Fixing Kit)
- Moulded Base Shroud

HCOU2332
 Colour – Cobalt
 (Premium Diablo Vinyl)



HCOU2332
 Low transfer height

HCOU2331	Mobile 3 Section – Hydraulic with LWB and Manual Backrest operation	£1,099.00
HCOU2332	Mobile 3 Section – Electric with LWB and Manual Backrest operation	£1,099.00

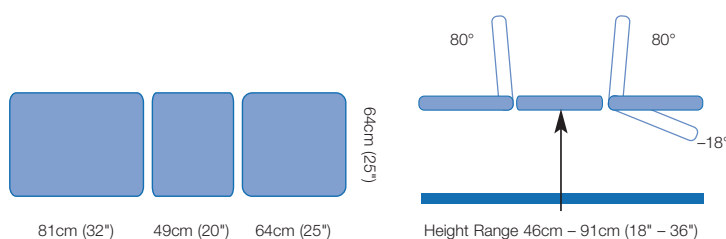

STREAMLINE™ 225

Contourline™
 COMFORT UPHOLSTERY





AKRON

Day Care Couch

Designed to provide comfort and pressure relief for patients undergoing lengthy examinations and periods of inactivity between clinics. This couch is suitable for oncology units, dialysis and other procedures where the patient is required to remain on the couch for long periods.

Features

- Incorporates 'Bi-Flex®' pressure relieving mattress
- Handswitch control for height, tilt, CPR and backrest adjustment
- Vertical lifting height range of 50cm to 94cm (20" - 37")
- Electric backrest operation 0-80°
- Positive/negative power assisted foot section
- Positive/negative tilt positioning -15° to +15°
- Linked large wheel base (LWB) with steering facility
- Fold-down Side Supports/Armrests
- Battery Backup with individual function lock out facility
- Automatic levelling
- Automatic CPR positioning
- Standard width 70cm
- Choice of upholstery colours - see page 39

Optional accessories - see pages 60-61

- Paper Roll Holder
- IV Pole (requires Fixing Kit)
- Detachable Head Cushion



HCOU5982 Day Care Couch - Electric with LWB £3,025.00

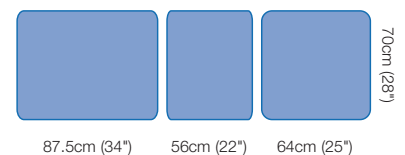
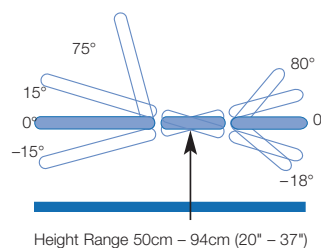

AKRON

STREAMLINE™ Merit Drop End

The key factor in the design of the Drop End Couch is for versatile patient positioning. The long backrest and short foot section provide a comfortable seated position for a wide range of examination procedures.

Features

- Safe working load of 225kgs
- Extremely strong and rigid
- Choice of hydraulic or electric height operation
- Retractable wheel base (RWB)
- Adjustable angle backrest from horizontal to +85°
- Positive and negative foot section angles +30° to -90°
- Mobile hoist compatible
- Self lubricating bearings
- Standard width 64cm (25")
- Choice of upholstery colours – see page 39

Options

- 70cm or 80cm Width at extra cost
- Choice of hand or footswitch operation on HCOU2282 at no extra cost

Optional accessories – see pages 60–61

- Breathing Hole and Plug
- Leg Supports (requires Fixing Kit)
- Stirrups (includes Fixing Kit)
- Arm Support Loops (requires Fixing Kit)
- Upholstered Arm Support (includes Fixing Kit)
- Moulded Arm Support (requires Fixing Kit)
- IV Pole (requires Fixing Kit)
- Paper Roll Holder
- Moulded Base Shroud
- Double Footswitch

HCOU2282
 Colour – Turquoise
 (Premium Diablo Vinyl)



HCOU2282
 Colour – Lilas
 (Premium Diablo Vinyl)



HCOU2281	Merit Drop End – Hydraulic with RWB and Manual Foot/Backrest	£885.00
HCOU2282	Merit Drop End – Electric with RWB and Manual Foot/Backrest	£885.00
HCOU2283	Merit Drop End – Electric with Electric Backrest Operation	£1,149.00
HCOU7329	Double Footswitch	£93.00

36cm (14") 56cm (22") 96.5cm (38")



Width 64cm (25") tapered at both ends

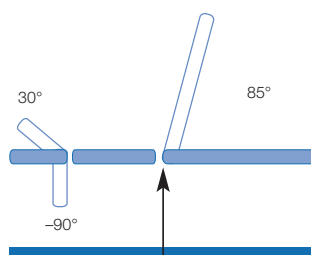

Height Range 49cm – 95cm (19" – 37")

STREAMLINE™ 225





AKRON

Phlebotomy Chair

Designed specifically for blood test procedures, the phlebotomy arms (supplied in pairs) are fitted to the **STREAMLINE™** Drop End Couches. The upholstered arms have a wide support surface with angular adjustment and are strong enough to support the patient as they mount or dismount from the couch.

Features

- Safe working load of 225kgs
- Extremely strong and rigid
- Choice of hydraulic or electric height operation
- Retractable wheel base (RWB)
- Adjustable angle backrest from horizontal to +85°
- Positive and negative foot section angles +30° to -90°
- Mobile hoist compatible
- Upholstered phlebotomy arms
- Self lubricating bearings
- Standard width 64cm (25")
- Choice of upholstery colours – see page 39

Options

- 70cm Width at extra cost
- Choice of hand or footswitch operation on HCOU2282B at no extra cost

Optional accessories – see pages 60–61

- Breathing Hole and Plug
- Leg Supports (requires Fixing Kit)
- Stirrups (includes Fixing Kit)
- Paper Roll Holder
- Moulded Base Shroud



HCOU2282B with optional shroud and fitted with phlebotomy arm kit
Colour – Lilas
(Premium Diablo Vinyl)

HCOU2281B	Phlebotomy Chair – Hydraulic with RWB and Manual Foot/Backrest operation	£1,085.00
HCOU2282B	Phlebotomy Chair – Electric with RWB and Manual Foot/Backrest operation	£1,085.00
HCOU7329	Double Footswitch	£93.00



STREAMLINE™ 225

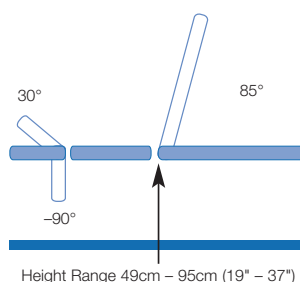

36cm (14") 56cm (22") 96.5cm (38")



Width 64cm (25") tapered at both ends

AKRON

STREAMLINE™ Ultra 3

Designed for ultrasound scanning and various other medical procedures the new **STREAMLINE™ Ultra 3** model provides electric positioning for height, tilt and backrest operation. The design provides a safe working load of 225kgs, with a low transfer height for ease of patient transfer.

Features

- Handswitch control for height, tilt and backrest operation
- Safe working load of 225kgs
- Retractable wheel base (RWB)
- Detachable Head Cushion
- Paper Roll Holder
- Mobile hoist compatible
- Self lubricating bearings
- Choice of upholstery colours – see page 39

Options

- **Contourline™** Comfort Upholstery

Optional accessories – see pages 60–61

- Moulded Base Shroud
- Arm Support Loops (requires Fixing Kit)
- Leg Supports (requires Fixing Kit)
- Stirrups (includes Fixing Kit)
- IV Pole (requires Fixing Kit)
- Moulded Arm Support (requires Fixing Kit)
- Upholstered Arm Support (includes Fixing Kit)
- Triple Footswitch
- Matching Operator's Chair or Stool

HCOU2265
 STREAMLINE Ultra 3
 Colour – Oriflamme
 (Premium Diablo Vinyl)



Low level transfer



HCOU2265
 STREAMLINE Ultra 3 with
 optional leg supports

HCOU2265	Ultra 3 – Electric with RWB	£2,655.00
HCOU7330	Triple Footswitch	£123.00

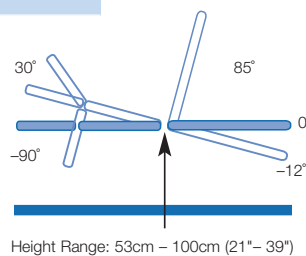
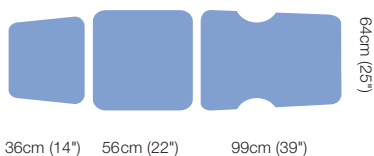

STREAMLINE™ 225





AKRON

Echo 2 Couch

The Echo 2 has been designed to provide a number of new features to improve clinical assessment and patient positioning. The backrest design facilitates access and clearance for the transducer during scanning procedures and can be further enhanced by tilting the couch in either a positive or negative direction.

Features

- Handswitch control for height, tilt, CPR and backrest adjustment
- Retractable wheel base (RWB)
- Adjustable arm support for clinician
- Integral footrest and fold-down seat section
- Fold-down side support and matching pad
- Detachable head cushion
- Paper roll holder
- Patient hand grip
- Choice of upholstery colours – see page 41
- Hinge covers
- Battery back up with individual function lock out facility

Optional Accessories

- Matching Operator's Chair or Stool

HCOU5962
Echo 2
Right-hand scan
Colour – Manderine
(Premium Diablo Vinyl)



HCOU5962 Negative Tilt



HCOU5962
with Adjustable Arm Support

HCOU5962	Echo 2 – Right-hand Scan	£2,795.00
HCOU5972	Echo 2 – Left-hand Scan	£2,795.00

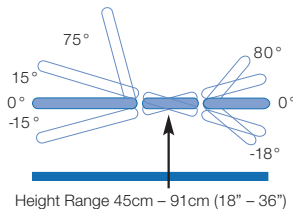

HCOU5962
Echo 2 Right-hand Scan

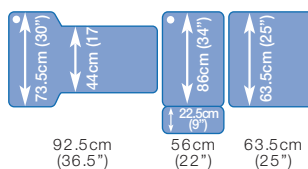

HCOU5972
Echo 2 Left-hand Scan

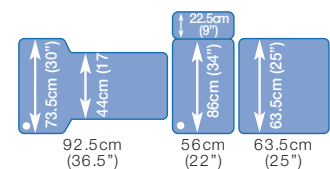

AKRON

STREAMLINE™

General Purpose Couch – GP3

The new **STREAMLINE™** General Purpose couch (GP3) has an increased safe working load of 225kgs and has electric positioning for height, tilt and backrest operation.

The foot sections can be lowered to -90° to provide more room for clinical procedures.

Features

- Safe working load of 225kgs
- Handswitch control for height, tilt and backrest operation
- Retractable wheel base (RWB)
- Fold-down Armrests
- Power assisted foot section adjustment
- Extending foot section design
- Detachable Head Cushion
- Paper Roll Holder
- Standard width 64cm (25")
- Self lubricating bearings
- Choice of upholstery colours – see page 39

Optional accessories – see pages 60–61

- Moulded Base Shroud
- Heel Pad
- Leg Supports (requires Fixing Kit)
- Stirrups (includes Fixing Kit)
- Upholstered Arm Support (includes Fixing Kit)
- Moulded Arm Support (requires Fixing Kit)
- Arm Support Loops (requires Fixing Kit)
- Matching Operators Chair or Stool
- Orthopaedic accessories – see page 56
- Triple Footswitch



HCOU2275 STREAMLINE
 GP3
 Colour – Oriflamme
 (Premium Diablo Vinyl)



Optional Heel Pad



HCOU2275 STREAMLINE GP3
 with optional shroud

HCOU2275	GP3 – Electric with RWB	£2,325.00
HCOU7330	Triple Footswitch	£123.00
HCOU1010	Heel Pad	£25.00

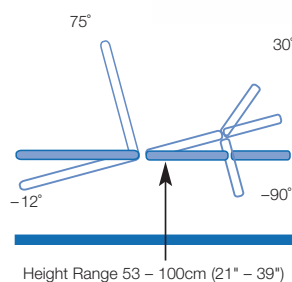
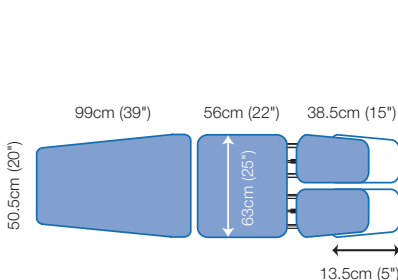

STREAMLINE™ 225
Contourline™
 COMFORT UPHOLSTERY



AKRON

STREAMLINE™ General Purpose Couch (GP2 & GP1)

The new **STREAMLINE™** General Purpose couch (GP2 and GP1) has an increased safe working load of 225kgs.

The height and backrest are electrically controlled by handswitch as standard on the GP2. The foot sections can be lowered to -90° to provide more room for clinical procedures.

Features

- Safe working load of 225kgs
- Choice of electric or hydraulic height control (GP1 only)
- Choice of hand or footswitch on electric model (GP 2 and GP1 Electric only)
- Retractable wheel base (RWB)
- Fold-down Armrests
- Power assisted foot section adjustment
- Extending foot section design
- Detachable Head Cushion
- Paper Roll Holder
- Standard width 64cm (25")
- Self lubricating bearings
- Choice of upholstery – see page 39



HCOU2272 **STREAMLINE**
GP1 Electric
Colour – Light Blue



HCOU2274 **STREAMLINE**
GP2 with Electric Backrest
Colour – Dark Blue

Optional accessories – see pages 60–61

- Moulded Base Shroud
- Heel Pad – see page 55
- Leg Supports (requires Fixing Kit)
- Stirrups (includes Fixing Kit)
- Upholstered Arm Support (includes Fixing Kit)
- Moulded Arm Support (requires Fixing Kit)
- Matching Operators Chair or Stool
- Arm Support Loops (requires Fixing Kit)
- Orthopaedic accessories
- Double Footswitch (GP2 only)



Leg Roller



Seat Raiser



Arm Support Kit



Leg Support Slider Kit

Orthopaedic Accessories (for use with GP3, GP2 and GP1)

HCOU1063	Leg Roller	£119.00
HCOU1064	Seat Raiser	£95.00
HCOU1065	Arm Support Kit – Requires Fixing Kit	£119.00
HCOU1066	Leg Support Slider Kit – Includes Fixing Kit	£157.00
HCOU7318	Fixing Kit	£50.00

HCOU2274	GP2 – Electric with RWB	£1,995.00
HCOU2272	GP1 – Electric with RWB	£1,095.00
HCOU2271	GP1 – Hydraulic with RWB	£1,095.00
HCOU7329	Double Footswitch (GP2 only)	£93.00



STREAMLINE™ 225

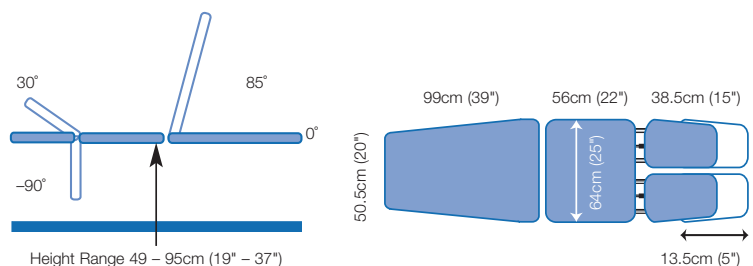

AKRON

STREAMLINE™ Gynae 3 De Luxe

The new **STREAMLINE™** Gynae 3 De Luxe models provide electric positioning for height, tilt and backrest operation.

Features include an increased safe working load of 225kgs, a moulded shroud, choice of seat extension and a matching operators chair which are all supplied as standard.

Features

- Safe working load of 225kgs
- Moulded base shroud
- Removable Seat Extension
- Handswitch control for height, tilt and backrest operation
- Retractable wheel base (RWB)
- Removable debris tray
- Matching operators chair (HCOU8600)
- Leg Supports and Arm Support Loops
- Detachable Head Cushion
- Paper Roll Holder
- Mobile hoist compatible
- Self lubricating bearings
- Choice of upholstery colours – see page 39

Options

- **Contourline™** Comfort Upholstery

Optional accessories

- Triple Footswitch
- IV Pole (requires Fixing Kit)



HCOU2257
 Colour – Lilas
 (Premium Diablo Vinyl)

Matching operators chair
 HCOU8600



HCOU2257	Gynae 3 De Luxe – Electric with RWB and Removable Seat Extension	£3,325.00
HCOU7330	Triple Footswitch	£123.00

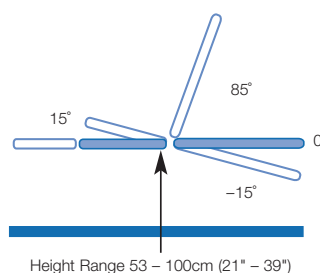
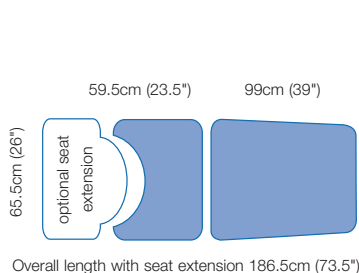

STREAMLINE™ 225

Contourline™
 COMFORT UPHOLSTERY





AKRON

STREAMLINE™ Gynae 3

The new **STREAMLINE™** Gynae 3 model provides electric positioning for height, tilt and backrest operation. Features include an increased safe working load of 225kgs and options of a moulded shroud, choice of seat extension and a matching operators chair.

Features

- Safe working load of 225kgs
- Handswitch control for height, tilt and backrest operation
- Retractable wheel base (RWB)
- Removable debris tray
- Leg Supports and Arm Support Loops
- Detachable Head Cushion
- Paper Roll Holder
- Mobile hoist compatible
- Self lubricating bearings
- Choice of upholstery colours – see page 39

Optional accessories

- Moulded Base Shroud
- Removable Seat Extension
- Operator's Chair
- Triple Footswitch
- Stirrups (includes Fixing Kit)



HCOU2255
Colour – Cobalt
(Premium Diablo Vinyl)



HCOU7303 Removable Seat Extension



HCOU7330 Triple Footswitch

HCOU2255	Gynae 3 – Electric with RWB	£2,895.00
HCOU7330	Triple Footswitch	£123.00
HCOU7303	Removable Seat Extension	£155.00

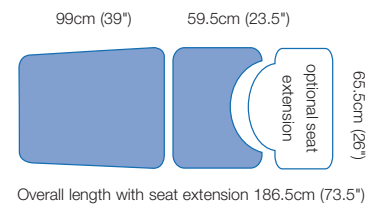
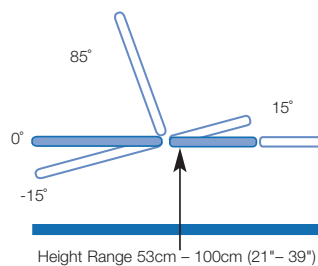

AKRON

STREAMLINE™ Gynae 2

The **STREAMLINE™** Gynae 2 provides electric positioning with two electric motors for height and backrest operation.

Features

- Safe working load of 225kgs
- Handswitch control for height and backrest operation
- Retractable wheel base (RWB)
- Leg Supports and Arm Support Loops
- Removable debris tray
- Detachable Head Cushion
- Paper Roll Holder
- Mobile hoist compatible
- Self lubricating bearings
- Choice of upholstery colours – see page 39

Optional accessories

- Moulded Base Shroud
- Removable Seat Extension
- Operators Chair
- Double Footswitch



HCOU2254
 STREAMLINE™ Gynae 2
 Colour – Terracotta
 (Premium Diabolo Vinyl)



HCOU2251
 STREAMLINE™ Gynae 1
 Electric with RWB
 Colour – Rousillon
 (Premium Diabolo Vinyl)

STREAMLINE™ Gynae 1

At entry level, the **STREAMLINE™** Gynae 1 provides effective positioning for a variety of simple procedures. There is a choice of hydraulic or electric height operation.

Backrest adjustment is power assisted and there is a choice of optional seat extension and accessories.

The couch has an increased safe working load of 225kgs.

Features

- Safe working load of 225kgs
- Choice of hydraulic or electric height operation
- Choice of hand or footswitch on electric models
- Retractable wheel base (RWB)
- Leg Supports and Arm Support Loops
- Power assisted backrest
- Removable debris tray
- Detachable Head Cushion
- Paper Roll Holder
- Mobile hoist compatible
- Self lubricating bearings
- Choice of upholstery colours – see page 39



HCOU7303 Removable Seat Extension



HCOU7329 Double Footswitch

HCOU2254	Gynae 2 – Electric with RWB	£1,789.00
HCOU2252	Gynae 1 – Electric with RWB	£1,329.00
HCOU2251	Gynae 1 – Hydraulic with RWB	£1,329.00
HCOU7329	Double Footswitch	£93.00

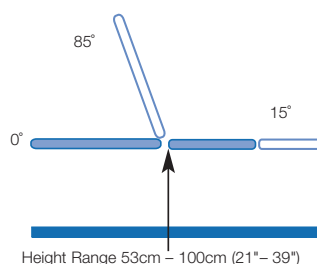
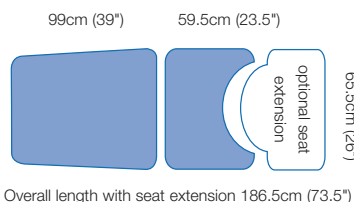



AKRON

Leg Supports

The multi-adjustable padded leg supports provide patient comfort in the lithotomy position. Requires fixing kit.

HCOU7309	Leg Supports (pair)	£182.00
HCOU7320	Fixing Kit for Merit 2/3 Models	£45.00
HCOU7317	Fixing Kit for Ultra 3, GP and Drop End Models	£50.00



Stirrups

An alternative to Leg Supports for gynaecology procedures. Requires fixing kit for attachment.

HCOU3295	Stirrups (pair)	£95.00
HCOU7320	Fixing Kit for Merit 2/3 Models	£45.00
HCOU7317	Fixing Kit Ultra 3, GP and Drop End Models	£50.00



Shroud Option

The aesthetically moulded shroud provides increased hygiene as it is far easier to clean and disinfect. Available as a cost option on the *STREAMLINE™* range.

HCOU2007	Optional Shroud – Streamline Models	£220.00
----------	--	---------



Detachable Head Cushion

The foam padded detachable head cushion is available in matching vinyl to your couch or plinth. This support provides additional comfort for the patient both in a seated or lying position and can also be used beneath the lower limbs. This support is easily attached or removed by Velcro straps.

HCOUHC-1	Detachable Head Cushion	£33.00
----------	-------------------------	--------



Paper Roll Holder

The paper roll holder permits full extension of the paper over the whole length of the couch. Roll width capacity – 60cm.

HCOU3294	Paper Roll Holder	£24.00
----------	-------------------	--------



Breathing Hole and Plug

The breathing hole and plug allows patients to be treated while lying in the prone position.

HCOU-BH	Breathing Hole and Plug	£32.00
---------	-------------------------	--------

AKRON

Side Support Pads (Pair)

Providing additional comfort and safety for patients. Can be quickly and simply secured to either nylon coated or chrome side supports.

HCOU1038	Side Support Pads 58cm/23" (pair)	£101.00
HCOU1039	Side Support Pads 89cm/35" (pair)	£101.00

Fold-down Side Supports (Pair)

Providing additional patient safety. 2 section couches require 89cm (35"). 3 section couches require 58cm (23").

HCOU1028	Nylon coated Side Supports 58cm/23" (pair)	£119.00
HCOU1034	Nylon coated Side Supports 89cm/35" (pair)	£119.00
HCOU1029	Chrome plated Side Supports 58cm/23" (pair)	£186.00
HCOU1036	Chrome plated Side Supports 89cm/35" (pair)	£186.00

IV Pole

Can be mounted on either side of the couch and is easily removable. Telescopic height adjustment. Requires fixing kit.

HCOU7334	IV Pole	£69.00
HCOU7320	Fixing Kit for above	£45.00

Upholstered Arm Support

A positional aid for procedures and examinations of the lower arm and hand (available for most models and includes fixing kit).

HCOU3293	Upholstered Arm Support	£119.00
----------	-------------------------	---------

Moulded Arm Support

A multi adjustable moulded arm support for phlebotomy procedures. Requires fixing kit.

HCOU7301	Moulded Arm Support	£124.00
HCOU7320	Fixing Kit Merit 2/3 and Drop End	£45.00
HCOU7318	Fixing Kit for GP and Ultra	£50.00

Arm Support Loops

The arm support loops are available for the Ultra 3, Drop End and GP range. Requires fixing kit.

HCOU7310	Arm Support Loops	£69.00
HCOU7318	Fixing Kit for GP and Ultra	£50.00





AKRON Themed Stickers

This latest innovation provides the user the opportunity to select from a range of themed stickers to enhance the product and surrounding treatment area to therefore reduce fear for young children facing medical procedures.

Features

- Choice of themed stickers, all reusable, transferable and washable
- Ideal for applying to products with shroud option
- Will adhere to vinyl and painted surfaces

HCOU9001	Undersea Adventures Themed Stickers	£50.00
HCOU9002	Funky Flowers Themed Stickers	£50.00
HCOU9003	Outer Space Themed Stickers	£50.00
HCOU9005	Jungle Safari Themed Stickers	£50.00

Other characters available upon request – please ask for details

AKRON Operators Chairs and Stools

Colour – Light Blue



HCOU8600

HCOU8700

Colour – Beige



HCOU8500

HCOU8500D

HCOU8600D

This high quality range of chairs and stools all feature recovery foam upholstery for additional comfort.

All models are adjustable in height.

The de luxe model also includes a seat tilt function and higher backrest for additional support.

The standard chair and stool are also available with a greater height range (draftsman version) and therefore include a foot ring and glides rather than castors for additional safety and security.

For colour of upholstery – see page 39

HCOU8600	Standard Operators Chair. Height Range 47–60cm (18"– 24") Adjustable height/angle of backrest, 5 star base with castors	£162.00
HCOU8700	De Luxe Operators Chair. Height Range 47–60cm (18"– 24") Adjustable height/angle of backrest, seat angle adjustment, 5 star base with braked castors	£209.00
HCOU8500	Standard Operators Stool. Height Range 47–60cm (18"– 24") 5 star base with castors	£152.00
HCOU8500D	Operators Stool Draftsman Version. Height Range 56–82cm (22"– 32") Adjustable foot ring, 5 star base with glides	£189.00
HCOU8600D	Operators Chair Draftsman Version. Height Range 56–82cm (22"– 32") Adjustable foot ring, 5 star base with glides, adjustable height/angle of backrest	£199.00



JPM Saddle Stool



- Easy Gas lift
- Height Adjustable
- 5 wheel star base
- Flame retardant foam and upholstery
- Available in Black, Blue, Grey and White
- Standard height range: 50 – 65 cms
- Higher height range: 59 – 75 cms

HCOU8800	Saddle Stool Standard Height	£149.00
HCOU8801	Saddle Stool Higher Height	£159.00



Premium Tilting Saddle Stools

- Adjustable seat locks in any position
- Rust-proof base
- As well as being height adjustable the stool will tilt to put the seat at a different angle for perfect comfort
- Height range: 54 – 71cms
- Higher height range: 63 – 84cms



HCOU8802 & HCOU8803 with short seat
 Available in Black or Blue



HCOU8804 & HCOU8805 with longer seat
 Available in Black, Blue or Pink

HCOU8802	Premium Tilting Saddle Stool with Short Seat – Standard Height	£249.00
HCOU8803	Premium Tilting Saddle Stool with Short Seat – Higher Height	£259.00
HCOU8804	Premium Tilting Saddle Stool with Longer Seat – Standard Height	£249.00
HCOU8805	Premium Tilting Saddle Stool with Longer Seat – Higher Height	£259.00



Premium Lightweight Couch

- Aluminium Frame with leather style PU Vinyl
- Extremely light weight, professional portable couch
- Strong aluminium frame construction with locking leg struts combined with high tensile ropes
- The table top is amazingly responsive and comfortable created by durable woven straps support
- Round Edges lift back with multi adjustment and face hole
- Allows easy access at each end for close seated work and versatility of treatment options
- Complete with carry bag
- Setup dimension: 186cm(L) x 61cm(W) x 67– 80cm(H)
- Foldup dimension: 93cm(L) x 61cm(W) x 20cm(D)
- Weight 12 kgs
- Maximum user weight 200kg (31 stone)



HCOU8810	Premium Lightweight Couch – Navy	£379.00
----------	----------------------------------	---------



Specialist Couches

Anti-bacterial Upholstery IN 14 COLOURS



- Multi position self locking adjustable dual backrest/foot rest (on three section model)
- Cupboards include pull-out work surface, pull-out basket, shelf and lock as standard
- Luxury high performance (flame retardant) 65mm deep anti-bacterial upholstery
- Quality, durable, easy to clean materials
- Maximum user weight 165 kgs
- All cabinets are supplied fully assembled
- Durable silver epoxy coated frame
- Paper roll holder included (can be located at head or foot end)
- British made
- 3 year warranty
- CE marked
- Optional accessories allow you to personalise the couch
- Dimensions: 83cm(H) x 193cm(L) x 60cm(W) (with paper roll holder)

The **Specialist** treatment couch system is the most versatile solution available for today's healthcare professionals. Choose from two different cabinet combinations, five contemporary finishes in 'high gloss' white, titanium, maple, beech and cool blue. Available with two or our unique three section **anti-bacterial** upholstery in fourteen colours.



HCS1M/3S
Specialist 3 Section Couch with 2 drawerline units and 1 drawer pack in Maple effect finish with Grey Upholstery (Head pillow extra)

Installation Service
Per couch
£45



HCS1M
Specialist 2 Section Couch with 2 drawerline units and 1 drawer pack in Maple effect finish with Grey Upholstery (Head pillow and leg supports extra)



Specialist couches with 3 section upholstery

HCS1W/3S	Specialist Couch with 2 Drawerline Units & 1 Drawer Pack in White	£1350.00
HCS1M/3S	Specialist Couch with 2 Drawerline Units & 1 Drawer Pack in Maple	£1350.00
HCS1T/3S	Specialist Couch with 2 Drawerline Units & 1 Drawer Pack in Titanium	£1350.00
HCS1B/3S	Specialist Couch with 2 Drawerline Units & 1 Drawer Pack in Beech	£1350.00
HCS1CB/3S	Specialist Couch with 2 Drawerline Units & 1 Drawer Pack in Cool Blue	£1350.00
HINST1	Couch Installation and Commissioning including Packaging Recycle	£45.00

Specialist couches with 2 section upholstery

HCS1W	Specialist Couch with 2 Drawerline Units & 1 Drawer Pack in White	£1275.00
HCS1M	Specialist Couch with 2 Drawerline Units & 1 Drawer Pack in Maple	£1275.00
HCS1T	Specialist Couch with 2 Drawerline Units & 1 Drawer Pack in Titanium	£1275.00
HCS1B	Specialist Couch with 2 Drawerline Units & 1 Drawer Pack in Beech	£1275.00
HCS1CB	Specialist Couch with 2 Drawerline Units & 1 Drawer Pack in Cool Blue	£1275.00

Anti-bacterial Upholstery IN 14 COLOURS



HCS3M/3S
 Specialist 3 Section Couch with 1 drawerline unit and 1 drawer pack in Maple effect finish with Grey Upholstery (Head pillow extra)



HCS3M
 Specialist 2 Section Couch with 1 drawerline unit and 1 drawer pack in Maple effect finish with Grey Upholstery (Head pillow and leg supports extra)

Specialist couches with 3 section upholstery

HCS3W/3S	Specialist Couch with 1 Drawerline Unit & 1 Drawer Pack in White	£1050.00
HCS3M/3S	Specialist Couch with 1 Drawerline Unit & 1 Drawer Pack in Maple	£1050.00
HCS3T/3S	Specialist Couch with 1 Drawerline Unit & 1 Drawer Pack in Titanium	£1050.00
HCS3B/3S	Specialist Couch with 1 Drawerline Unit & 1 Drawer Pack in Beech	£1050.00
HCS3CB/3S	Specialist Couch with 1 Drawerline Unit & 1 Drawer Pack in Cool Blue	£1050.00
HINST1	Couch Installation and Commissioning including Packaging Recycle	£45.00

Specialist couches with 2 section upholstery

HCS3W	Specialist Couch with 1 Drawerline Unit & 1 Drawer Pack in White	£975.00
HCS3M	Specialist Couch with 1 Drawerline Unit & 1 Drawer Pack in Maple	£975.00
HCS3T	Specialist Couch with 1 Drawerline Unit & 1 Drawer Pack in Titanium	£975.00
HCS3B	Specialist Couch with 1 Drawerline Unit & 1 Drawer Pack in Beech	£975.00
HCS3CB	Specialist Couch with 1 Drawerline Unit & 1 Drawer Pack in Cool Blue	£975.00

Cabinet Finishes



HCS1W
 White 'High Gloss' finish with Sky Blue Upholstery



HCS3T
 Titanium 'High Gloss' finish with Black Upholstery



HCS1B
 Beech effect finish with Beige Upholstery



HCS3CB
 Cool Blue 'High Gloss' finish with Navy Upholstery

Accessories – * Must be ordered with couch



HCBH1
 * Breathing Hole
 £30.00



HCHP1
 * Couch Head Pillow
 £49.50



HSTP1
 Single Tier Step – oval
 SWL: 165kg
 £65.00



HSTP2
 Double Tier Step – oval
 SWL: 165kg
 £119.00



HSTP3
 Single Tier Step
 SWL: 165kg
 £55.00



HCDT1
 Drawer Tidy
 £15.00



HLEG1
 * Leg Supports (pair)
 £215.00

Upholstery Colours – Please specify when ordering

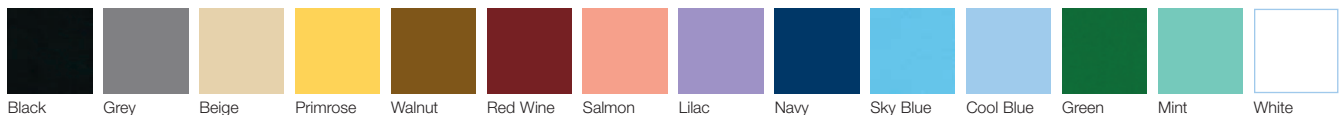



Practitioner Deluxe Couches

The **Practitioner Deluxe** couch range is available with optional drawer and pull-out work surfaces in five finishes 'high gloss' white, titanium, maple, beech and cool blue. The **Practitioner** combines both treatment and storage solutions with excellent comfort for the patient.

**Anti-bacterial
Upholstery
IN 14
COLOURS**



HMEC1 – Practitioner couch with black upholstery (head pillow and leg supports extra).

HMCD1T – Drawer unit in titanium

HCMU1T – Mobile storage unit in titanium

HSTP3 – Single Tier Step

- Exceptionally stable and durable deluxe couch
- Maximum user weight 165kgs
- 1, 2 or 3 drawer unit options or combine with pull-out work surfaces
- Durable high performance anti-bacterial upholstery
- Optional mobile storage cabinet, with single drawer, locking door and optional pull-out basket
- Stylish 60mm diameter legs for stability
- Four adjustable feet for uneven floors
- Multi-position self locking adjustable backrest
- Paper roll holder included (can be located at head or foot end)
- 3 year warranty
- CE marked
- Dimensions: 79cm(H) x 193cm(L) x 60cm(W) (with paper roll holder)

**Installation
Service**
Per couch
£45

HMEC1	Practitioner Deluxe Couch	£379.00
HCPS2W	Pull-out Work Surface – White (each)	£99.00
HCPS2M	Pull-out Work Surface – Maple (each)	£99.00
HCPS2T	Pull-out Work Surface – Titanium (each)	£99.00
HCPS2B	Pull-out Work Surface – Beech (each)	£99.00
HCPS2CB	Pull-out Work Surface – Cool Blue (each)	£99.00
HMCD1W	Drawer Unit – White (each)	£109.00
HMCD1M	Drawer Unit – Maple (each)	£109.00
HMCD1T	Drawer Unit – Titanium (each)	£109.00
HMCD1B	Drawer Unit – Beech (each)	£109.00
HMCD1CB	Drawer Unit – Cool Blue (each)	£109.00
HCMU1W	Mobile Storage Unit – White	£195.00
HCMU1M	Mobile Storage Unit – Maple	£195.00
HCMU1T	Mobile Storage Unit – Titanium	£195.00
HCMU1B	Mobile Storage Unit – Beech	£195.00
HCMU1CB	Mobile Storage Unit – Cool Blue	£195.00



Drawer and Cabinet Finishes



White 'High Gloss' finish
 with Sky Blue Upholstery
 (Head Pillow extra)



Maple effect finish
 with Beige Upholstery



Beech effect finish
 with Green Upholstery



Cool Blue 'High Gloss' finish
 with Navy Upholstery

Accessories – * Must be ordered with couch



HCBH1
 * Breathing Hole
 £30.00



HCHP1
 * Couch Head Pillow
 £49.50



HSTP1
 Single Tier Step – oval
 SWL: 165kg
 £65.00



HSTP2
 Double Tier Step – oval
 SWL: 165kg
 £119.00



HSTP3
 Single Tier Step
 SWL: 165kg
 £55.00



HCDD1
 Drawer Tidy
 £15.00



HLEG1
 * Leg Supports (pair)
 £215.00



HPB1
 * Pull-out Basket
 £45.00

Upholstery Colours – Please specify when ordering

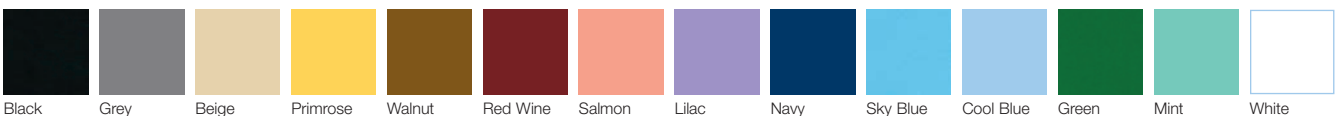

Black Grey Beige Primrose Walnut Red Wine Salmon Lilac Navy Sky Blue Cool Blue Green Mint White



Colenso Examination Couch

The **Colenso** couch is exceptionally stable, durable and comfortable for the client. Optional accessories allow you to personalise the couch.

- Durable high performance upholstery in fourteen colours
- Maximum user weight 165kgs
- Quality, durable, easy to clean materials
- Durable silver epoxy coated frame
- Paper roll holder included (fits at head or foot end)
- 3 year warranty
- CE marked
- Dimensions: 78cm(H) x 193cm(L) x 60cm(W) (with paper roll holder)

Please see page 67 for accessories



**Anti-bacterial
Upholstery
IN 14
COLOURS**



Please specify upholstery colour when ordering – see page 67

HMEC2	Colenso Examination Couch	£275.00
-------	---------------------------	---------

Alberti Rest Couch

The **Alberti Rest** couch has been designed for first aid rooms, schools, sports centres or similar environments where a lower resting height position is required.

- Exceptionally stable and stylish rest couch
- Luxury high performance (flame retardant) upholstery with rounded corners and anti-bacterial additive helping to reduce MRSA and other bacteria
- Only 50cm high
- Maximum user weight 165kgs
- Quality, durable, easy to clean materials
- Paper roll holder included (fits at head or foot end)
- 3 year warranty
- CE marked
- Optional accessories available – Breathing Hole, Head Pillow and Steps (please see page 67)



**Anti-bacterial
Upholstery
IN 14
COLOURS**



Please specify upholstery colour when ordering – see page 67

HMRC1	Alberti Rest Couch	£349.00
-------	--------------------	---------

Portable Couch

Lightweight, strong, durable and easy to clean, ideal for occasional use or where space is at a premium.

- Multi-position adjustable back rest
- Durable, easy to clean blue upholstery
- Adjustable height range 64-80cm
- Breathing hole and plug as standard
- Maximum user weight 150kg
- Durable wipe clean upholstery
- Weight 15kg
- Carry Bag and Head Cradle supplied free of charge
- Dimensions: 64-80cm(H) x 184cm(L) x 66cm(W)



Upholstery Colours



HMPC1/DB	Portable Couch – Blue Upholstery	£265.00
HMPC1/BLK	Portable Couch – Black Upholstery	£265.00
HMPC1/WH	Portable Couch – White Upholstery	£265.00

Carry Bag and Head Cradle supplied Free of Charge with each Portable Couch





Anti-bacterial Upholstery IN 14 COLOURS

Gas-lift Chair

- Adjustable height range 42cm – 57cm
- Comfortable padded seat and back
- Durable wipe clean **anti-bacterial** upholstery in 14 Colours
- Maximum user weight 110kg (17 stone)



HCHA1
 (Shown in Grey)

HCHA1	Gas-lift Chair (without arms)	£109.00
HCHA2	Gas-lift Chair (with arms)	£119.00

Gas-lift Chair with Foot Ring

- Adjustable height range 48cm – 68cm
- Stylish chrome foot ring
- Comfortable padded seat and back
- Durable wipe clean **anti-bacterial** upholstery in 14 Colours
- Maximum user weight 110kg (17 stone)



HCHA4
 (Shown in Black)

HCHA3	Gas-lift Chair with Foot Ring (without arms)	£149.00
HCHA4	Gas-lift Chair with Foot Ring (with arms)	£159.00

High Level Gas-lift Chair with Foot Ring

- Adjustable height range 55cm – 81cm
- Stylish chrome foot ring
- Comfortable padded seat and back
- Durable wipe clean **anti-bacterial** upholstery in 14 Colours
- Maximum user weight 110kg (17 stone)



HCHA5
 (Shown in Navy)

HCHA5	High Level Gas-lift Chair with Foot Ring	£169.00
-------	--	---------

Gas-lift Stool

- Adjustable height range 42cm – 58cm
- Comfortable padded seat
- Durable wipe clean **anti-bacterial** upholstery in 14 Colours
- Five castor base for stability
- Maximum user weight 110kg (17 stone)



HST02
 (Shown in Sky Blue)

HST02	Gas-lift Stool	£99.00
-------	----------------	--------

Gas-lift Stool with Foot Ring

- Adjustable height range 51cm – 69cm
- Stylish chrome foot ring
- Comfortable padded seat
- Durable wipe clean **anti-bacterial** upholstery in 14 Colours
- Five castor base for stability
- Maximum user weight 110kg (17 stone)



HST02
 (Shown in Beige)

HST03	Gas-lift Stool with Foot Ring	£139.00
-------	-------------------------------	---------

Upholstery Colours – Please specify when ordering

