









COLLECTION
#2017



ZUIVER^o

OUR TABLE OF CONTENTS

CHECK OUT THE CATEGORIES

CHAIRS	PAGE 2	
TABLES	PAGE 26	
SEATERS	PAGE 50	
CABINETS	PAGE 66	
CARPETS	PAGE 76	
LIGHTING	PAGE 92	
HOME DECO	PAGE 142	
DISPLAYS	PAGE 170	

IT'S PARTY TIME

At Zuiver it's always one big party! Throughout the year we celebrate the launch of new products. As soon as a new product meets our Zuiver DNA requirements, we roll out the red carpet to the photo studio and present the new Zuiver items to the general public.

My wish to extend Zuiver's collection to include home accessories this year has become reality! It was a real 'wow' moment when the samples recently arrived. Turn to the Home Deco section on page 142 to discover our new beauties.

In May this year we could hardly believe our luck. After having won the "Zaanse ondernemersprijs" (regional enterprise award) in 2015, we're delighted to have scooped up another award in 2016. This time we were awarded as the best enterprise of the province North Holland!

Another happy moment with a lot of champagne was when our new chair rolled off the production line. It had been our long-time wish to design and launch a moulded chair and now.... TA-DA! With great pride we present to you the Zuiver Albert Kuip chair! Together with design studio APE we worked and worked on this chair until it was worthy of the Zuiver stamp. In fact, we're so proud of this chair that we left the stamp on the bottom! Read the story of Albert Kuip on page 4-5.

As you'd expect, we also added lots of Zuiver items to our other product categories. Flick through the catalogue at your leisure and spot the new items by the 'NEW' stamp.

Having your own Zuiver party? Don't forget to tag us in your photos using #zuiver

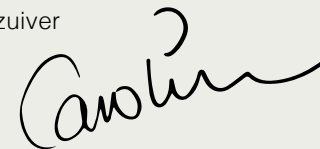



“I love powdery colours like taupe, soft grey and faded pink. They look stunning combined with marble, but also with olive green, plants, copper... The possibilities are endless with our Zuiver items.”

Art director Caroline van Velze





CHAIRS





CHAIRS



THE STORY OF ALBERT KUIP

“Design a moulded chair that perfectly fits our Zuiver DNA”. That was our brief for design studio APE. Not the easiest of assignments, but they’ve pulled it off. After 18 months of designing, 3D printing and refining and developing their design, we can now finally present to you our pride and joy: the Albert Kuip chair!

APE is an Amsterdam-based design studio consisting of Gert, Tom, Lennert and Douwe. “When Zuiver approached us with this assignment, we were full of ideas from the word go. Our chief starting point was a distinctive chair that is first and foremost really comfortable”, Lennert says.

It wasn’t long before APE showed us their first design. Douwe: “For all our designs we always create an in-house 3D printed scale model. The first rough design we presented hit the right note. Once the final design was agreed upon, we created full-size prototypes to allow us to optimise the chair.

The name of the Albert Kuip chair is a humorous nod to the famous Albert Cuyp outdoor market in Amsterdam. “It’s all about word play of course, because in Dutch, ‘Cuyp’ is pronounced the same as ‘kuip’, which is another term for a moulded seat. Then there’s the fact that our studio is located in Amsterdam, so it’s also an indirect reference to us”, Gert explains.

APE: “What we’re most proud of is the actual comfort of the chair”

What the men are most proud of is the seating comfort of the chair. Douwe: “You can use it for active sitting, but you can also just chill out on it. Not an easy combination to achieve in a chair. It’s the slightly flexible back rest that makes this possible. As we see it, Albert Kuip is the ultimate combination of comfort, design appeal and quality.”

Because of its robustness, this moulded chair is well suited for commercial projects. Tom: “The aluminium connecting piece ensures a strong connection between the moulded seat and base frame, while at the same time giving the chair an airy appearance. Even so, we designed Albert Kuip as a dining room chair; that’s why the armrests will fit under virtually any table.

APE: “As we see it, Albert Kuip is the ultimate combination of comfort, design appeal and quality.”

In the meantime, the APE men are busy creating a follow up to the Albert Kuip chair. “There’s a perfect match between us and Zuiver. Doing this project has given us lots of new ideas. We can’t say much about it at this stage”, Tom continues, “but there will be another collaborative project with Zuiver”.

Are you curious? Keep an eye on our website and social media for the latest developments!



APE from left to right: Gert, Tom, Lennert & Douwe



CHAIRS



ALBERT KUIP CHAIR

NEW

Zuiver Albert Kuip is a special one, we knew it from the very first moment. We designed this baby together with Dutch design studio APE. But Albert Kuip is not just eye candy, it's also most comfortable!

Chair Albert Kuip is a moulded chair, available with and without armrests. We thought that besides natural colours like grey and white, you would also appreciate the seat in trendy powdery colours like taupe and old pink.

Did we already mention the flawless sturdy transition from seat to legs? Oh yeah, Albert Kuip is sturdy and steady! The elegant legs are made of solid ash wood. Very classy if you ask us!

Working and relaxing, that's what Albert Kuip is made for. Use Albert Kuip as a dining chair or desk chair, it's up to you!



ZUIVER-CODE	GTIN-CODE	ITEM NAME		
1100292	8718548030992	CHAIR ALBERT KUIP WHITE		
1100293	8718548031005	CHAIR ALBERT KUIP DARK GREY		
1100294	8718548031012	CHAIR ALBERT KUIP LIGHT GREY		
1100295	8718548031029	CHAIR ALBERT KUIP OLD PINK		
1100296	8718548031036	CHAIR ALBERT KUIP TAUPE		
PACKING	2 PCS/CTN	ORDER QTY: 2 PCS		
QTY	CTN SIZE (CM)	CBM	NW (KG)	GW (KG)
2	51x49x60	0,15	8,08	10,08
PRICE (1 PCS)			RETAIL € 149,00	

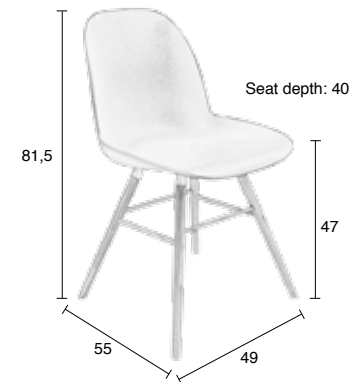



ALBERT KUIP ARMCHAIR NEW

Registered design
 100% polypropylene shell
 Solid ash wood legs
 Aluminium frame
 Maximum weight load: 140 kg



ZUIVER-CODE	GTIN-CODE	ITEM NAME		
1200131	8718548031043	ARMCHAIR ALBERT KUIP WHITE		
1200132	8718548031050	ARMCHAIR ALBERT KUIP DARK GREY		
1200133	8718548031067	ARMCHAIR ALBERT KUIP LIGHT GREY		
1200134	8718548031074	ARMCHAIR ALBERT KUIP OLD PINK		
1200135	8718548031081	ARMCHAIR ALBERT KUIP TAUPE		
PACKING	2 PCS/CTN	ORDER QTY: 2 PCS		
QTY	CTN SIZE (CM)	CBM	NW (KG)	GW (KG)
2	62x56x61	0,21	8,12	10,12
PRICE (1 PCS)			RETAIL € 179,00	

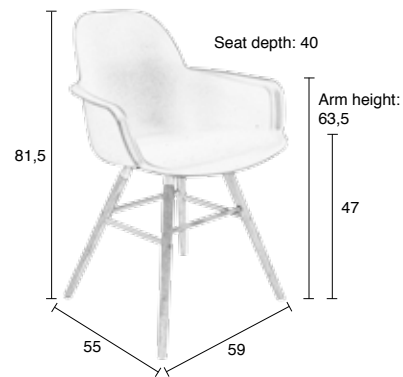



SYL

What defines an armchair? Or an office chair? Or even a conference chair, and what about a dining room chair? We combined the characteristics of all these chairs in armchair Syl. The result is this very hybrid armchair, with its swivel base and comfortable seat. A chair that can be used anywhere you want. Syl comes with PU-leather accents on the armrests. So rest those arms as much as you like! It will never hurt your Syl.

- 100% polyester upholstery
- Armrests covered with vintage PU-leather
- Plywood shell with PU-foam, density 35
- Black powder coated steel swivel star base
- Maximum weight load: 120 kg

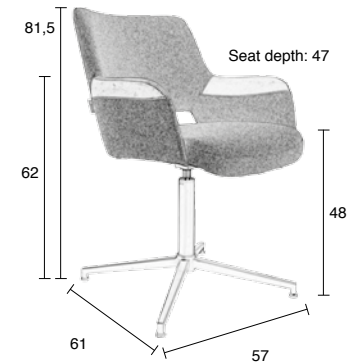

ZUIVER-CODE	GTIN-CODE	ITEM NAME		
1200122	8718548024892	ARMCHAIR SYL BROWN		
1200123	8718548024908	ARMCHAIR SYL BLACK		
PACKING	1 PCS/CTN			
QTY	CTN SIZE (CM)	CBM	NW (KG)	GW (KG)
1	63x60x48	0,181	10	13
PRICE (1 PCS)			RETAIL € 289,00	



BEAU

The perfect chair for a dining room table of an industrial loft or any other dining room table for that matter. However armchair Beau, with its swivel foot, is ultra versatile and therefore easily at home in your office, a conference room or even in your lounge area. Beau's upholstery is a combination of high quality PU-leather and a patterned fabric for the cushion. See, versatility has no boundaries at Zuiver.

Vintage PU-leather upholstery
 100% polyester seat cushion
 Plywood shell with PU-foam, density 38
 Black powder coated steel swivel base
 Maximum weight load: 120 kg

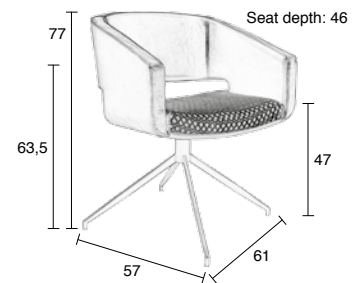

ZUIVER-CODE	GTIN-CODE	ITEM NAME		
1200124	8718548024915	ARMCHAIR BEAU BLACK		
1200128	8718548029217	ARMCHAIR BEAU BROWN		
PACKING	2 PCS/CTN	ORDER QTY: 2 PCS		
QTY	CTN SIZE (CM)	CBM	NW (KG)	GW (KG)
2	73x68x88	0,437	29 (2x14,5)	33
PRICE (1 PCS)			RETAIL € 339,00	



CHAIRS



OMG

Yes, we did it. We named this chair OMG. Does this abbreviation stand for what it usually stands for? We recommend you try it. Sit down in this very, very comfy chair and decide for yourself. O, and OMG comes in no less than six different colours. OMG!

Padded upholstery in 100% polyester
 >50.000 Martindale, colour fastness 4,5-5
 Plywood shell with high density foam
 Black powder coated steel frame
 Maximum weight load: 120 kg

ZUIVER-CODE	GTIN-CODE	ITEM NAME		
1100169	8718548017337	CHAIR OMG LIGHT GREY		
1100170	8718548017344	CHAIR OMG BLACK		
1100171	8718548017351	CHAIR OMG CAMEL		
1100172	8718548017368	CHAIR OMG GREEN		
1100173	8718548017375	CHAIR OMG BLUE		
1100174	8718548017382	CHAIR OMG ORANGE		
PACKING	2 PCS/CTN	ORDER QTY: 2 PCS		
QTY	CTN SIZE (CM)	CBM	NW (KG)	GW (KG)
2	55x57x52	0,163	13 (2x6,5)	16
PRICE (1 PCS)			RETAIL € 159,00	
ZUIVER-CODE	GTIN-CODE	ITEM NAME		
9100028	8718548026667	FOOTPLUG TUBE 13MM SET OF 4		
PACKING	20 SETS/CTN	ORDER QTY: 20 SETS OF 4		
QTY	CTN SIZE (CM)	CBM	NW (KG)	GW (KG)
20	20x15x15	0,0045	1	1,05
PRICE (1 SET OF 4)			RETAIL € 7,50	



light grey



black



camel



green



blue



orange

Note: Zuiver recommends to order different foot caps for use on wooden or other delicate floors

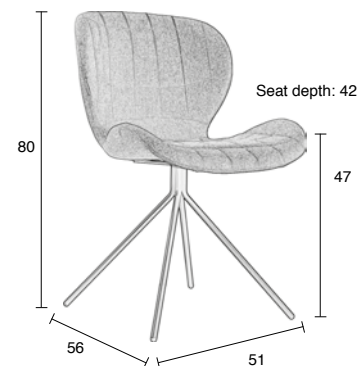



OMG LL

OMG! Look at this new OMG!
 It's upholstered with a material called leather look.
 Our high quality PU-leather, to be specific. PU-leather stands for less-trouble-and-just-as-much-style-as-leather. As you know we have named this chair OMG for that is the most frequently used expression of comfort when one sits in it. Of course our new OMG LL chair has maintained the same comfort as the original and comes in a whopping five colours. OMG!

Padded upholstery in vintage PU-leather
 Plywood shell with high density foam
 Black powder coated steel frame
 Maximum weight load: 120 kg

ZUIVER-CODE	GTIN-CODE	ITEM NAME		
1100250	8718548024038	CHAIR OMG LL PETROL		
1100251	8718548024052	CHAIR OMG LL YELLOW		
1100252	8718548024076	CHAIR OMG LL GREY		
1100253	8718548024090	CHAIR OMG LL BROWN		
1100257	8718548024113	CHAIR OMG LL BLACK		
PACKING	2 PCS/CTN	ORDER QTY: 2 PCS		
QTY	CTN SIZE (CM)	CBM	NW (KG)	GW (KG)
2	55x57x52	0,163	13 (2x6,5)	16
PRICE (1 PCS)			RETAIL € 169,00	
ZUIVER-CODE	GTIN-CODE	ITEM NAME		
9100028	8718548026667	FOOTPLUG TUBE 13MM SET OF 4		
PACKING	20 SETS/CTN	ORDER QTY: 20 SETS OF 4		
QTY	CTN SIZE (CM)	CBM	NW (KG)	GW (KG)
20	20x15x15	0,0045	1	1,05
PRICE (1 SET OF 4)			RETAIL € 7,50	



petrol



yellow



grey



brown



black

Note: Zuiver recommends to order different foot caps for use on wooden or other delicate floors

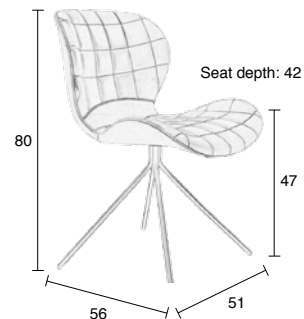



OMG OFFICE

So, our OMG chair turned out to be such a success and so comfy, a lot of people started to use it as an office chair. No problem there, of course, but we tend to listen to our customers and decided an official OMG office chair would even be better. And so we went along and made one. Office Chair OMG comes with a black frame and in two sophisticated colours: Grey and blue. OMG!

Office swivel chair, adjustable in height
 Plywood shell with padded upholstery
 100% polyester, >50.000 Martindale,
 colour fastness 4,5-5
 5-star black powder coated base (Ø 65 cm)
 with black castors
 Maximum weight load: 120 kg

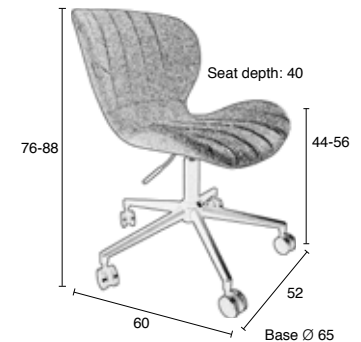

ZUIVER-CODE	GTIN-CODE	ITEM NAME		
1300001	8718548019294	OFFICE CHAIR OMG BLACK/GREY		
1300002	8718548019300	OFFICE CHAIR OMG BLACK/BLUE		
PACKING	1 PCS/CTN			
QTY	CTN SIZE (CM)	CBM	NW (KG)	GW (KG)
1	62x62x52	0,199	9,8	13
PRICE (1 PCS)			RETAIL € 219,00	



DOULTON OFFICE NEW

Because we like to help you choose and because we like variation, especially in our bestsellers, we created this new Doulton Vintage Brown for you, in an office version. It has castors! Now you can roll smoothly backwards from your desk. Or... from your dining table... Or conference table. O, boy, still a lot of choices! Sorry 'bout that.

Office swivel chair, adjustable in height
 Plywood shell with padded upholstery
 Fabric: 100% polyester, > 50.000 Martindale, colour fastness 4,5-5
 Vintage PU-leather on seat and back
 Polyether foam, density: 30-35
 4- star black powder coated steel base with black castors
 Maximum weight load: 120 kg

ZUIVER-CODE	GTIN-CODE	ITEM NAME		
1300003	8718548031425	OFFICE CHAIR DOULTON VINTAGE BROWN		
PACKING	1 PCS/CTN			
QTY	CTN SIZE (CM)	CBM	NW (KG)	GW (KG)
1	69x69x40	0,19	9	12
PRICE (1 PCS)			RETAIL € 319,00	

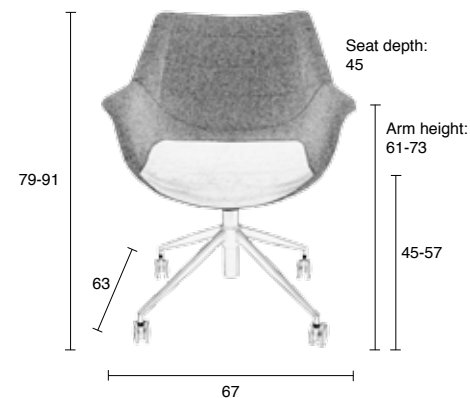

CHAIRS



DOULTON

How classy can an office chair be? Our Doulton is so classy we can't decide if it is a dining chair, an office chair or a modern armchair. The thing is, Doulton can fulfill all these functions. So it is actually up to you! To make it even harder to choose, we added Doulton vintage brown to the series! Just as comfortable as its all-fabric brothers, but for this one we combined fabric and a fabulous looking PU-leather.

We just leave you with an inside tip: Imagine how Doulton combines with our OMG chair...

Plywood shell with padded upholstery

Fabric: 100% polyester, >50.000 Martindale, colour fastness 4,5-5

Vintage version: brown vintage PU-leather on seat & back

Foam density: 30-35

Black powder coated steel frame

Maximum weight load: 120 kg

ZUIVER-CODE	GTIN-CODE	ITEM NAME		
1200112	8718548021037	ARMCHAIR DOULTON GREY		
1200113	8718548021044	ARMCHAIR DOULTON GREEN		
1200114	8718548021051	ARMCHAIR DOULTON BLUE		
1200119	8718548023611	ARMCHAIR DOULTON VINTAGE BROWN		
PACKING	2 PCS/CTN	ORDER QTY: 2 PCS		
QTY	CTN SIZE (CM)	CBM	NW (KG)	GW (KG)
2	74x69x65	0,332	16 (2x8)	20
PRICE GREY/GREEN/BLUE (1 PCS)			RETAIL € 249,00	
PRICE VINTAGE BROWN (1 PCS)			RETAIL € 259,00	



grey



green



blue



vintage brown

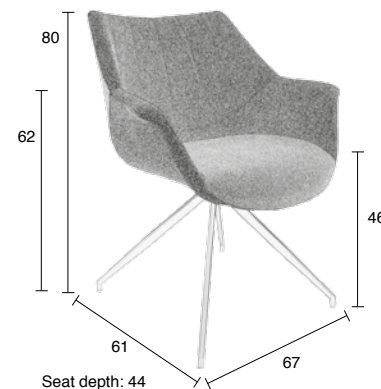



DIAMOND

Our new brainchild, Diamond is no doubt the most posh chair of the Zuiver family. With its shiny copper plated cantilever frame and rich fabric it is so chic you don't just sit down on it, but 'compose oneself on it'. We added a diamond pattern to the stitching of the upholstery. We left it at that, because we clearly reached perfection right there!

Back and seat in diamond stitched fabric with piping
 Fabric: 100% polyester, > 25.000 Martindale
 Foam density seat 30, back 25
 Copper plated frame with glides
 The kink frame is stackable (5 pcs)
 Maximum weight load: 120 kg

🇩🇪 The regular frames are not available in Germany

ZUIVER-CODE	GTIN-CODE	ITEM NAME		
1100270	8718548025967	CHAIR DIAMOND ROYAL RED		
1100271	8718548025974	CHAIR DIAMOND MINTY GREEN		
1100272	8718548025981	CHAIR DIAMOND EMERALD GREEN		
1100273	8718548025998	CHAIR DIAMOND PEBBLE GREY		
1100274	8718548026001	CHAIR DIAMOND KINK ROYAL RED		
1100275	8718548026018	CHAIR DIAMOND KINK MINTY GREEN		
1100276	8718548026025	CHAIR DIAMOND KINK EMERALD GREEN		
1100277	8718548026032	CHAIR DIAMOND KINK PEBBLE GREY		
PACKING	1 OR 2 PCS/CTN (MIX OF DIFFERENT COLOURS POSSIBLE)			
QTY	CTN SIZE (CM)	CBM	NW (KG)	GW (KG)
1	87x62x54	0,291	6,4	7,9
2	100x50x62	0,310	12,8	14,7
PRICE (1 PCS)				RETAIL € 219,00

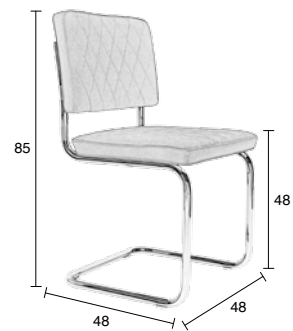

royal red



minty green



emerald green



pebble grey



CHAIRS



TWELVE

“9, 10, 11, Twelve. Ready or not here it comes!”
 Meet Twelve, our famous seat. Comes in five different colours. No, let us rephrase that: Twelve comes in two different styles. Ok, between you and me: Twelve has five different faces, Twelve is unique, Twelve is an eye catcher! Let's see, there is the patchwork version, colourful or grey, or the leather look in black, white or stylish vintage brown. Just pick your favorite!

Plastic shell with padded upholstery
 Patchwork fabric: 100% polyester, colour fastness 4-5, Martindale > 20.000
 Leatherlook: 100% PU-leather, colour fastness 3-4
 Foam density: 30
 Beech legs
 Maximum weight load: 140 kg

ZUIVER-CODE	GTIN-CODE	ITEM NAME		
1100266	8718548025776	CHAIR TWELVE PATCHWORK		
1100267	8718548025790	CHAIR TWELVE PATCHWORK GREY		
1100268	8718548025813	CHAIR TWELVE WHITE LL		
1100269	8718548025837	CHAIR TWELVE BLACK LL		
PACKING	2 PCS/CTN	ORDER QTY: 2 PCS		
QTY	CTN SIZE (CM)	CBM	NW (KG)	GW (KG)
2	64x62x51	0,2	15 (2x7,5)	17
PRICE (1 PCS)			RETAIL € 179,00	

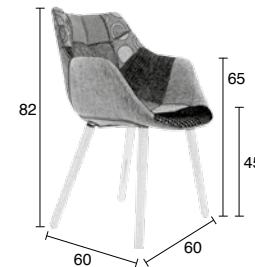

patchwork



patchwork grey



white LL



black LL



FLEXBACK

Boing, boing, boing. Do you know that feeling chairs with flexible backs give you? We tend to test that ability for the first 5 minutes. In our Flexback chair you can test that bounce all day. Every day if you like. Because Zuivers Flexback will never lose its resilience.

Plastic shell with upholstery in grey or dark grey
 Fabric: 100% polyester, colour fastness 3-4
 Foam density: 35 D
 Solid beech legs, natural or black lacquered
 Maximum weight load: 110 kg



natural/dark grey



natural/grey



black/dark grey



black/grey

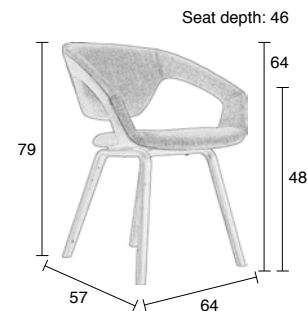

ZUIVER-CODE	GTIN-CODE	ITEM NAME		
1200096	8718548017184	ARMCHAIR FLEXBACK NATURAL/DARK GREY		
1200098	8718548017207	ARMCHAIR FLEXBACK BLACK/DARK GREY		
1200126	8718548026940	ARMCHAIR FLEXBACK NATURAL/GREY		
1200127	8718548026957	ARMCHAIR FLEXBACK BLACK/GREY		
PACKING	2 PCS/CTN	ORDER QTY: 2 PCS		
QTY	CTN SIZE (CM)	CBM	NW (KG)	GW (KG)
2	64x61x44	0,172	15,6 (2x7,8)	17,6
PRICE (1 PCS)			RETAIL € 199,00	



RIDGE SERIES

Feel free to build your own chair with our Ridge series. There are so many options, it is basically a custom built chair. Choose your fabric, your colour, armrests or not? Want it in chrome or brushed? High (the barstool), or low? Choices, choices. But what a wonderful series of chairs.

Chair Ridge has a classic nostalgic feel to it, yet, its colours and fabrics are always hip and modern. The very comfortable Ridge Rib comes in a spectacular amount of colours. If you prefer an even more nostalgic feel, then choose Ridge Vintage, with its 100% cotton fabric in three ancient colours for a real vintage experience. The Ridge is available as chair, armchair and barstool with a chromed frame. The chair is also available in brushed chrome. Do you prefer Ridge to be stackable? Then choose Ridge Kink.

Chair, armchair or barstool

Back and seat with piping

Fabrics to choose from:

- ribcord fabric with piping (88% nylon, 12% polyester, >40.000 Martindale)
- vintage look with piping (100% cotton)

Foam density seat 30, back 25

Chromed frame with glides

Regular chair frame in brushed chrome as well

The kink frame is stackable: 4 pcs with arm, 5 pcs without arm

Armrest in bakelite

Maximum weight load: 120 kg

🇩🇪 The regular frames are not available in Germany

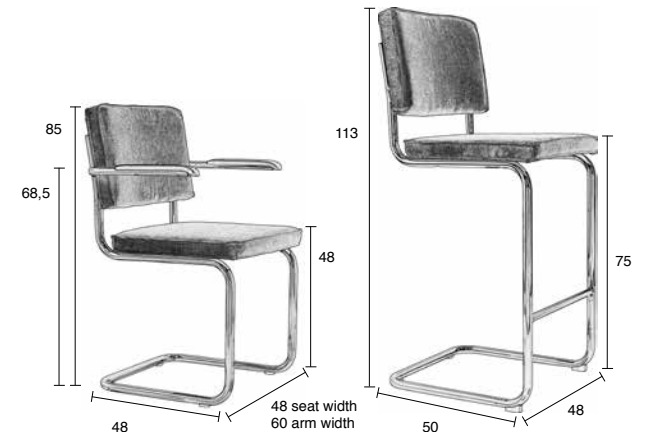



PICK A FRAME



chair (brushed or chromed)



kink chair



armchair



kink armchair



barstool



kink barstool

CHOOSE YOUR FABRIC



cool grey



blue



yellow



orange



green



red



grey



black



sailor blue



mediocre grey



charcoal



chromed



brushed



CHAIRS



RIDGE CHAIR (CHROMED)

ZUIVER-CODE	GTIN-CODE	ITEM NAME		
1006001	8718548002753	CHAIR RIDGE RIB BLACK 7A		
1006002	8718548002760	CHAIR RIDGE RIB RED 21A		
1006003	8718548002777	CHAIR RIDGE RIB ORANGE 19A		
1006005	8718548002791	CHAIR RIDGE RIB GREY 6A		
1006007	8718548002814	CHAIR RIDGE RIB BLUE 12A		
1006009	8718548002838	CHAIR RIDGE RIB GREEN 25A		
1006010	8718548002845	CHAIR RIDGE RIB YELLOW 24A		
1100076	8718548014022	CHAIR RIDGE RIB COOL GREY 32A		
1100104	8718548015135	CHAIR RIDGE VINTAGE SAILOR BLUE 11		
1100105	8718548015142	CHAIR RIDGE VINTAGE MEDIOCRE GREY 12		
1100106	8718548015159	CHAIR RIDGE VINTAGE CHARCOAL 16		
PACKING	1 OR 2 PCS/CTN (MIX OF DIFFERENT COLOURS POSSIBLE)			
QTY	CTN SIZE (CM)	CBM	NW (KG)	GW (KG)
1	87x62x54	0,291	6,4	7,9
2	100x50x62	0,310	12,8	14,7
PRICE (1 PCS)				RETAIL € 129,00

RIDGE CHAIR (BRUSHED)

ZUIVER-CODE	GTIN-CODE	ITEM NAME		
1100078	8718548014503	CHAIR RIDGE BRUSHED RIB BLACK 7A		
1100079	8718548014510	CHAIR RIDGE BRUSHED RIB RED 21A		
1100080	8718548014527	CHAIR RIDGE BRUSHED RIB ORANGE 19A		
1100082	8718548014541	CHAIR RIDGE BRUSHED RIB GREY 6A		
1100084	8718548014565	CHAIR RIDGE BRUSHED RIB BLUE 12A		
1100086	8718548014589	CHAIR RIDGE BRUSHED RIB GREEN 25A		
1100087	8718548014596	CHAIR RIDGE BRUSHED RIB YELLOW 24A		
1100089	8718548014619	CHAIR RIDGE BRUSHED RIB COOL GREY 32A		
1100114	8718548015432	CHAIR RIDGE BRUSHED VINTAGE SAILOR BLUE 11		
1100115	8718548015449	CHAIR RIDGE BRUSHED VINTAGE MEDIOCRE GREY 12		
1100116	8718548015456	CHAIR RIDGE BRUSHED VINTAGE CHARCOAL 16		
PACKING	1 OR 2 PCS/CTN (MIX OF DIFFERENT COLOURS POSSIBLE)			
QTY	CTN SIZE (CM)	CBM	NW (KG)	GW (KG)
1	87x62x54	0,291	6,4	7,9
2	100x50x62	0,310	12,8	14,7
PRICE (1 PCS)				RETAIL € 149,00



RIDGE KINK CHAIR

ZUIVER-CODE	GTIN-CODE	ITEM NAME		
1100055	8718548013346	CHAIR RIDGE KINK RIB BLACK 7A		
1100056	8718548013353	CHAIR RIDGE KINK RIB RED 21A		
1100057	8718548013360	CHAIR RIDGE KINK RIB ORANGE 19A		
1100059	8718548013384	CHAIR RIDGE KINK RIB GREY 6A		
1100061	8718548013407	CHAIR RIDGE KINK RIB BLUE 12A		
1100063	8718548013421	CHAIR RIDGE KINK RIB GREEN 25A		
1100064	8718548013438	CHAIR RIDGE KINK RIB YELLOW 24A		
1100077	8718548014039	CHAIR RIDGE KINK RIB COOL GREY 32A		
1100109	8718548015289	CHAIR RIDGE KINK VINTAGE SAILOR BLUE 11		
1100110	8718548015296	CHAIR RIDGE KINK VINTAGE MEDIOCRE GREY 12		
1100111	8718548015302	CHAIR RIDGE KINK VINTAGE CHARCOAL 16		
PACKING	1 OR 2 PCS/CTN (MIX OF DIFFERENT COLOURS POSSIBLE)			
QTY	CTN SIZE (CM)	CBM	NW (KG)	GW (KG)
1	87x62x54	0,291	6,4	7,9
2	100x50x62	0,310	12,8	14,7
PRICE (1 PCS)			RETAIL € 129,00	



CHAIRS



RIDGE ARMCHAIR

ZUIVER-CODE	GTIN-CODE	ITEM NAME		
1006050	8718548002913	ARMCHAIR RIDGE RIB BLACK 7A		
1006051	8718548002920	ARMCHAIR RIDGE RIB RED 21A		
1006052	8718548002937	ARMCHAIR RIDGE RIB ORANGE 19A		
1006054	8718548002951	ARMCHAIR RIDGE RIB GREY 6A		
1006056	8718548002975	ARMCHAIR RIDGE RIB BLUE 12A		
1006058	8718548002999	ARMCHAIR RIDGE RIB GREEN 25A		
1006059	8718548003002	ARMCHAIR RIDGE RIB YELLOW 24A		
1200062	8718548014060	ARMCHAIR RIDGE RIB COOL GREY 32A		
1200068	8718548015180	ARMCHAIR RIDGE VINTAGE SAILOR BLUE 11		
1200069	8718548015197	ARMCHAIR RIDGE VINTAGE MEDIOCRE GREY 12		
1200070	8718548015203	ARMCHAIR RIDGE VINTAGE CHARCOAL 16		
PACKING	1 OR 2 PCS/CTN (MIX OF DIFFERENT COLOURS POSSIBLE)			
QTY	CTN SIZE (CM)	CBM	NW (KG)	GW (KG)
1	87x62x54	0,291	7,4	8,9
2	100x64x62	0,397	14,8	16,9
PRICE (1 PCS)				RETAIL € 189,00

RIDGE KINK ARMCHAIR

ZUIVER-CODE	GTIN-CODE	ITEM NAME		
1200044	8718548013506	ARMCHAIR RIDGE KINK RIB BLACK 7A		
1200045	8718548013513	ARMCHAIR RIDGE KINK RIB RED 21A		
1200046	8718548013520	ARMCHAIR RIDGE KINK RIB ORANGE 19A		
1200048	8718548013544	ARMCHAIR RIDGE KINK RIB GREY 6A		
1200050	8718548013568	ARMCHAIR RIDGE KINK RIB BLUE 12A		
1200052	8718548013582	ARMCHAIR RIDGE KINK RIB GREEN 25A		
1200053	8718548013599	ARMCHAIR RIDGE KINK RIB YELLOW 24A		
1200063	8718548014077	ARMCHAIR RIDGE KINK RIB COOL GREY 32A		
1200073	8718548015333	ARMCHAIR RIDGE KINK VINTAGE SAILOR BLUE 11		
1200074	8718548015340	ARMCHAIR RIDGE KINK VINTAGE MEDIOCRE GREY 12		
1200075	8718548015357	ARMCHAIR RIDGE KINK VINTAGE CHARCOAL 16		
PACKING	1 OR 2 PCS/CTN (MIX OF DIFFERENT COLOURS POSSIBLE)			
QTY	CTN SIZE (CM)	CBM	NW (KG)	GW (KG)
1	87x62x54	0,291	7,4	8,9
2	100x64x62	0,397	14,8	16,9
PRICE (1 PCS)				RETAIL € 189,00



RIDGE BARSTOOL

ZUIVER-CODE	GTIN-CODE	ITEM NAME		
1500201	8718548012295	BARSTOOL RIDGE RIB ORANGE 19A		
1500202	8718548012301	BARSTOOL RIDGE RIB BLACK 7A		
1500203	8718548012318	BARSTOOL RIDGE RIB RED 21A		
1500205	8718548012332	BARSTOOL RIDGE RIB GREY 6A		
1500206	8718548012349	BARSTOOL RIDGE RIB BLUE 12A		
1500208	8718548012363	BARSTOOL RIDGE RIB YELLOW 24A		
1500210	8718548012387	BARSTOOL RIDGE RIB GREEN 25A		
1500022	8718548014107	BARSTOOL RIDGE RIB COOL GREY 32A		
1500026	8718548015234	BARSTOOL RIDGE VINTAGE SAILOR BLUE 11		
1500027	8718548015241	BARSTOOL RIDGE VINTAGE MADIOCRE GREY 12		
1500028	8718548015258	BARSTOOL RIDGE VINTAGE CHARCOAL 16		
PACKING	1 PCS/CTN			
QTY	CTN SIZE (CM)	CBM	NW (KG)	GW (KG)
1	50x53x116	0,30	ca. 7	ca. 9
PRICE (1 PCS)		RETAIL € 189,00		

RIDGE KINK BARSTOOL

ZUIVER-CODE	GTIN-CODE	ITEM NAME		
1500001	8718548013728	BARSTOOL RIDGE KINK RIB ORANGE 19A		
1500002	8718548013735	BARSTOOL RIDGE KINK RIB BLACK 7A		
1500003	8718548013742	BARSTOOL RIDGE KINK RIB RED 21A		
1500005	8718548013766	BARSTOOL RIDGE KINK RIB GREY 6A		
1500006	8718548013773	BARSTOOL RIDGE KINK RIB BLUE 12A		
1500008	8718548013797	BARSTOOL RIDGE KINK RIB YELLOW 24A		
1500010	8718548013810	BARSTOOL RIDGE KINK RIB GREEN 25A		
1500023	8718548014114	BARSTOOL RIDGE KINK RIB COOL GREY 32A		
1500031	8718548015388	BARSTOOL RIDGE KINK VINTAGE SAILOR BLUE 11		
1500032	8718548015395	BARSTOOL RIDGE KINK VINTAGE MADIOCRE GREY 12		
1500033	8718548015401	BARSTOOL RIDGE KINK VINTAGE CHARCOAL 16		
PACKING	1 PCS/CTN			
QTY	CTN SIZE (CM)	CBM	NW (KG)	GW (KG)
1	50x53x116	0,30	ca. 7	ca. 9
PRICE (1 PCS)		RETAIL € 189,00		



LOUIX

Design: Alexandre Arazola



Designer Alexandre Arazola on the concept of his patented design: "The mix of two French designs classics, the XVIIIth century wood medallion LOUIS XVI chair and the industrial, galvanized sheet chair of the 1930s. A well-balanced mix of curved and straight lines, and a perfect marriage of the materials to provide the best comfort on a solid chair."

Chair Louix is clearly inspired by an industrial classic, but our translation comes with a twist. Alexander made it a real Zuiver with the comfy wooden seating, detailing, colours and comfort. Chair Louix comes in two colours. You see, we like to give you a choice...

Patented design
 Solid ash wood seat and back,
 natural or antique finished
 Steel frame in white or black;
 PU-lacquered
 Zuiver-logo embossed on back of seat
 Maximum weight load: 136 kg

ZUIVER-CODE	GTIN-CODE	ITEM NAME		
1100159	8718548017061	CHAIR LOUIX ANTIQUE BLACK		
1100160	8718548017078	CHAIR LOUIX NATURAL WHITE		
PACKING	2 PCS/CTN	ORDER QTY: 2 PCS		
QTY	CTN SIZE (CM)	CBM	NW (KG)	GW (KG)
2	64x56x99	0,35	17,5 (2x8,75)	20
PRICE (1 PCS)			RETAIL € 259,00	

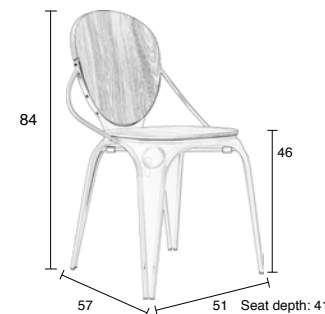



BACK TO SCHOOL

The old school chair lost all restraint! It shed its dull colours and is now all about vibrant, fun colours. Resulting in our chair Back to School. Back and seat are in plywood with HPL top layer and the steel frame makes the Back to School conveniently stackable.

Back and seat in plywood with HPL toplayer
 Steel frame, powder coated
 Stackable
 Maximum weight load: 125 kg



ZUIVER-CODE	GTIN-CODE	ITEM NAME		
1008201	8718548003620	CHAIR BACK TO SCHOOL HPL BLACK		
1008202	8718548003637	CHAIR BACK TO SCHOOL HPL WHITE		
1008203	8718548003644	CHAIR BACK TO SCHOOL HPL YELLOW		
1008204	8718548003651	CHAIR BACK TO SCHOOL HPL ORANGE		
1008207	8718548003682	CHAIR BACK TO SCHOOL HPL RED		
1100286	8718548026902	CHAIR BACK TO SCHOOL HPL GREY		
PACKING	4 PCS/CTN	ORDER QTY: 4 PCS		
QTY	CTN SIZE (CM)	CBM	NW (KG)	GW (KG)
4	48x58x120	0,334	20 (4x 5)	22
PRICE (1 PCS)		RETAIL € 89,00		

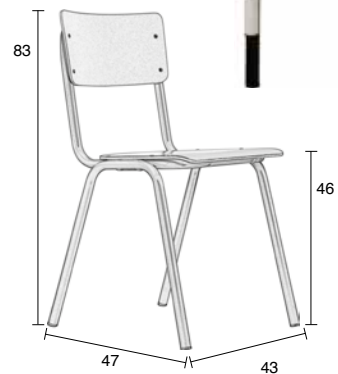



TABLES





TABLES

ZUIGER® COLLECTION 2017
NL RETAIL PRICES INCL. VAT



STORM

At first glance, you might just miss how table Storm is actually a work of art. Take a second look and you will see Storm is not just a pretty table, but is blessed with elaborate and great details. The v-groove in the table top is only one of its many details. Have you seen those artfully constructed ash wooden legs which seem to flow from the table top? Need we say more?

25 mm ash veneered MDF table top
 50 mm solid ash borders with engraved Zuiver-logo
 60 mm solid ash legs
 Clear or black PU-lacquered

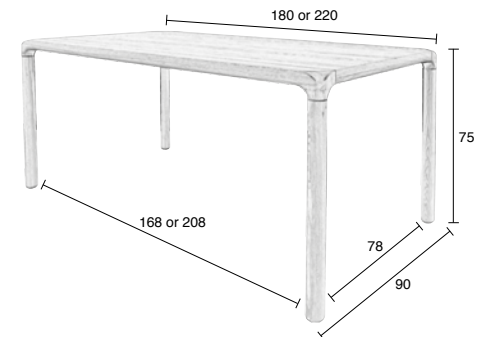

ZUIVER-CODE	GTIN-CODE	ITEM NAME		
2100065	8718548029156	TABLE STORM 180x90 NATURAL		
2100066	8718548029163	TABLE STORM 220x90 NATURAL		
2100069	8718548031388	TABLE STORM 180x90 BLACK		
2100070	8718548031395	TABLE STORM 220x90 BLACK		
PACKING	1 PCS/CTN			
SIZE	CTN SIZE (CM)	CBM	NW (KG)	GW (KG)
180x90	188x98x17	0,31	49	52
220x90	228x98x17	0,38	60	68
PRICE 180 (1 PCS)		RETAIL € 795,00		
PRICE 220 (1 PCS)		RETAIL € 895,00		



HIGH ON WOOD

How about this fantastic combination of classic, heavy oak with the huge contrast of sleek, glossy, super modern MDF? We love it. High on Wood is a big table too. More than enough space for a good size dinner party. Yes. Just the way we like it.

Solid oak base with MDF table top
Glossy white PU-lacquered

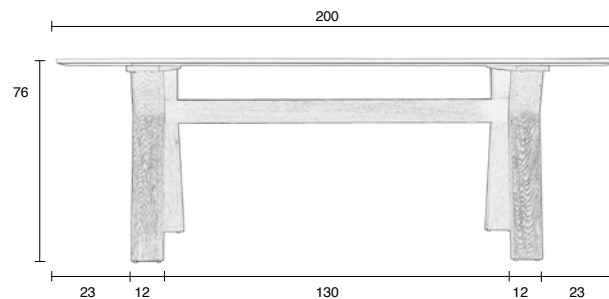
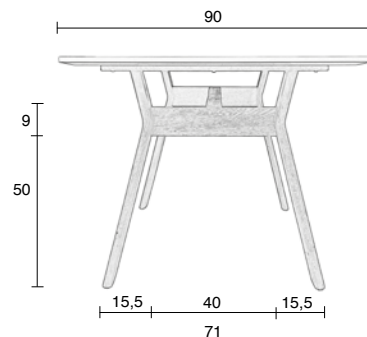

ZUIVER-CODE	GTIN-CODE	ITEM NAME		
2100048	8718548013254	TABLE HIGH ON WOOD		
PACKING	1 PCS/CTN			
QTY	CTN SIZE (CM)	CBM	NW (KG)	GW (KG)
1	210x98x21	0,40	47	48
PRICE (1 PCS)			RETAIL € 699,00	



A-FRAMED

4,8 cm solid pine top (2,4 cm + 2,4 cm sides)
 Solid pine A-frame (11x5,5 cm)
 White lacquered (water-based)

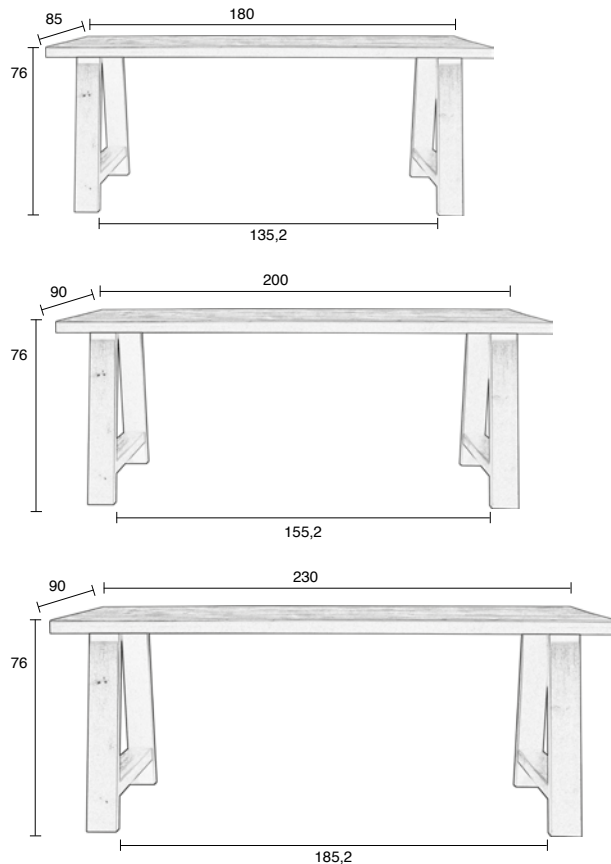

ZUIVER-CODE	GTIN-CODE	ITEM NAME		
2100056	8718548021983	TABLE A-FRAMED 180X85 WHITE		
2100057	8718548021990	TABLE A-FRAMED 200X90 WHITE		
2100058	8718548022003	TABLE A-FRAMED 230X90 WHITE		
PACKING		1 PCS / 2 CTN		
COMPONENT	CTN SIZE (CM)	CBM	NW (KG)	GW (KG)
TABLE TOP 180	ca. 182x87x5	0,079	22	22,5
TABLE TOP 200	ca. 202x92x5	0,093	25,5	26
TABLE TOP 230	ca. 232x92x5	0,107	28,5	29
LEGS	87x35x12	0,061	7,3	7,8
PRICE 180X85 (1 PCS)			RETAIL € 599,00	
PRICE 200X90 (1 PCS)			RETAIL € 649,00	
PRICE 230X90 (1 PCS)			RETAIL € 699,00	

We dare to say our A-Framed table is a zesty addition to your interior. Although this solid pine table is all white, you'll find it will still spice up your meals, or the work you'll finish at it. A-Framed got its name because of the striking frame we used. This table comes in several sizes, so it should always be able to find a place in any home. Or office, for that matter.



MARBLE KING 90'

NEW

A high gloss white marble tabletop. O boy, does it get any better? The marble pattern keeps intriguing. In fact it would be a shame to use a tablecloth on our Zuiver Marble King dining table. And not even necessary, since this shiny marble is so easy to clean! Table Marble King comes with a black or copper leg. O boy...

16 mm white marble table top on a melamine coated MDF layer (for extra strength)
 Stainless steel leg (Ø 7,6 cm) & base (Ø 50 cm)
 copper plated or powdercoated in matte black
 Maximum weight load: 75 kg

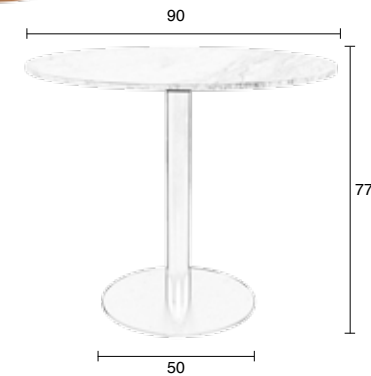

ZUIVER-CODE	GTIN-CODE	ITEM NAME		
2100071	8718548031432	TABLE MARBLE KING 90' COPPER		
2100072	8718548031494	TABLE MARBLE KING 90' BLACK		
PACKING	1 PCS/2 CTN			
COMPONENT	CTN SIZE (CM)	CBM	NW (KG)	GW (KG)
TABLE TOP	96x96x7	0,064	29	31
TABLE BASE	67x57x16	0,061	14,5	16,5
PRICE 180X85 (1 PCS)			RETAIL € 899,00	



TWISTED

Just look at our desk Twisted. Isn't she just the cutest workstation on this planet? We've experienced that most people only need a small workstation, somewhere in the home. But most of the time those are just as cold and clean as they sound: Workstations. Brrr.....Close that window please. So, we have designed a stylish one: Twisted. She's pretty. She is feminine. But in no way frumpy.

12 mm glossy white MDF table top
 Oak veneer drawer left, open space right
 Twisted rubber wood legs
 Maximum weight load: 70 kg

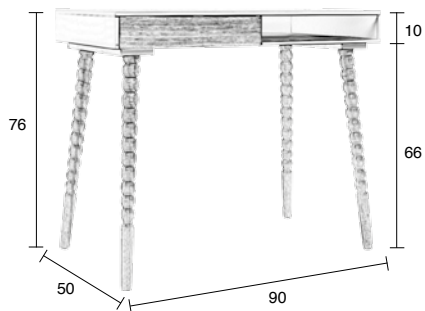

ZUIVER-CODE	GTIN-CODE	ITEM NAME		
2600001	8718548022393	DESK TABLE TWISTED		
PACKING	1 PCS/CTN			
QTY	CTN SIZE (CM)	CBM	NW (KG)	GW (KG)
1	100x58x18	0,104	15,2	17,2
PRICE (1 PCS)			RETAIL € 299,00	



BARBIER DESK TABLE NEW

Ready for some magic? Pull the handle and something unexpected happens! What looks like an ordinary table suddenly transforms into a beautiful desk table. Desk table Barbier has that typical Zuiver DNA. What's inside is even prettier than the outside. Done with work for the day? Store pens, papers and other notes inside, slide the table top back and get ready for the evening!

18 mm ash veneered MDF sides & retractable desk top
 Size desk top: 105,5x39,5 cm (WxD)
 Solid ash wood tambour roll top and legs
 2 compartments, MDF with ash-print foil
 Clear PU-lacquered
 Maximum weight load: 20 kg

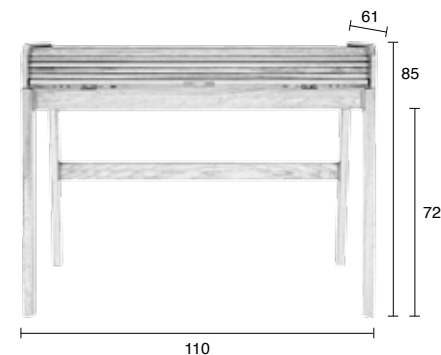

ZUIVER-CODE	GTIN-CODE	ITEM NAME		
2600004	8718548030732	DESK TABLE BARBIER		
PACKING	1 PCS/CTN			
QTY	CTN SIZE (CM)	CBM	NW (KG)	GW (KG)
1	116x53,5x25,5	0,16	21	24
PRICE (1 PCS)			RETAIL € 499,00	



BARBIER CONSOLE TABLE NEW

You just can't have enough console tables like Barbier. Show your favourite items on top of Barbier and hide your least favourite stuff inside! Your place will always be clean and tidy when friends or family come to visit unexpectedly. Yep, that's us. You can always count on Zuiver!

18 mm ash veneered MDF table top & bottom
 Solid ash wood tambour doors and legs (Ø 45 mm)
 Small divider inside, MDF with ash-print foil
 Clear PU-lacquered
 Maximum weight load: 30 kg

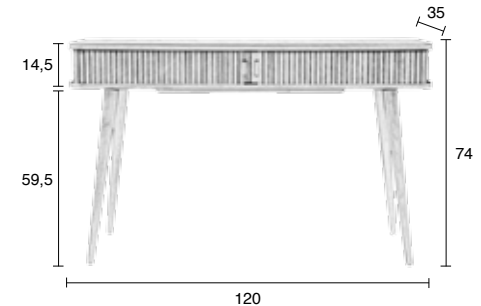

ZUIVER-CODE	GTIN-CODE	ITEM NAME		
2300097	8718548030763	CONSOLE TABLE BARBIER		
PACKING	1 PCS/CTN			
QTY	CTN SIZE (CM)	CBM	NW (KG)	GW (KG)
1	123,5x45,5x20,5	0,12	16	18
PRICE (1 PCS)			RETAIL € 349,00	



DENDRON

We've seen a lot of wooden side tables in our designing years. Yet side table Dendron, wasn't one of them. You can't help but picture this pretty wooden side table everywhere! It features simplicity, with nice details in the carved wooden top and it has a pretty woodgrain design made by Mother Nature herself. Dendron comes in two sizes and they overlap! Oh, what a joy!

Solid mango wood top (25 mm) and legs (42,5 mm)
 Dimensions:
 S: 43x45 cm (Ø x H)
 L: 60x40 cm (Ø x H)
 Maximum weight load: 25 kg



ZUIVER-CODE	GTIN-CODE	ITEM NAME		
2300059	8718548024977	SIDE TABLE DENDRON S		
2300060	8718548024984	SIDE TABLE DENDRON L		
PACKING	1 PCS/CTN			
SIZE	CTN SIZE (CM)	CBM	NW (KG)	GW (KG)
S	46x46x14	0,03	3,85	4,75
L	64x64x13	0,057	6,05	7,5
PRICE S (1 PCS)			RETAIL € 79,50	
PRICE L (1 PCS)			RETAIL € 119,00	



WHITE STONE

Zuiver adopted the Nature Trend with these White Stone tables. We have made White Stone side tables for everyone. This perfect combo of natural materials, oak and marble, comes in no less than three sizes. A house big or small, there is always one your size.

15 mm Italian marble top
 Solid oak frame and legs with oil finish
 Available in 3 sizes:
 S: 32x45 cm (Ø x H)
 M: 40x40 cm (Ø x H)
 L: 50x32 cm (Ø x H)
 Maximum weight load: 10 kg



ZUIVER-CODE	GTIN-CODE	ITEM NAME			
2300008	8718548011960	SIDE TABLE WHITE STONE L			
PACKING	1 PCS/CTN				
QTY	CTN SIZE (CM)	CBM	NW (KG)	GW (KG)	
1	56x56x9	0,03	9,8	10,7	
PRICE (1 PCS)			RETAIL € 169,00		
ZUIVER-CODE	GTIN-CODE	ITEM NAME			
2300009	8718548011977	SIDE TABLE WHITE STONE M			
PACKING	1 PCS/CTN				
QTY	CTN SIZE (CM)	CBM	NW (KG)	GW (KG)	
1	49x46x9	0,02	6,6	7,4	
PRICE (1 PCS)			RETAIL € 129,00		

ZUIVER-CODE	GTIN-CODE	ITEM NAME			
2300010	8718548011984	SIDE TABLE WHITE STONE S			
PACKING	1 PCS/CTN				
QTY	CTN SIZE (CM)	CBM	NW (KG)	GW (KG)	
1	56x38x9	0,02	4,6	5,3	
PRICE (1 PCS)			RETAIL € 109,00		



MARBLE POWER

An elegant black steel frame and a good slab of white marble. What a great combination! It gives Zuiver's Marble Power an architectural quality. Marble Power comes in two sizes: a bigger one which doubles as a coffee table and side table (imagine it with a collection of nicely styled accessories on top...!). The smaller version of the two, ideal to keep your book within arm's reach of your favourite chair.

19 mm marble top

Steel cube frame, black powder coated

Dimensions side table: 32x32x43 cm (WxDxH)

Dimensions coffee table: 90x40x35 cm (WxDxH)

Maximum weight load side table: 23 kg

Maximum weight load coffee table: 60 kg



ZUIVER-CODE	GTIN-CODE	ITEM NAME		
2300061	8718548024991	SIDE TABLE MARBLE POWER		
PACKING	1 PCS/CTN			
QTY	CTN SIZE (CM)	CBM	NW (KG)	GW (KG)
1	39x40,5x54,5	0,086	6,9	9
PRICE (1 PCS)			RETAIL € 119,00	

ZUIVER-CODE	GTIN-CODE	ITEM NAME		
2200017	8718548027596	COFFEE TABLE MARBLE POWER		
PACKING	1 PCS/CTN			
QTY	CTN SIZE (CM)	CBM	NW (KG)	GW (KG)
1	49,5x25,5x105	0,133	24,2	28,2
PRICE (1 PCS)			RETAIL € 399,00	



KARRARA NEW

At first glance, side table Karrara seems to defy gravity. A beautiful heavy marble table top on its very very slender legs. But make no mistake: Karrara is sturdy as can be as we made those thin legs out of unyielding iron. The result is an über elegant occasional table. Its small footprint makes it very easy to place in your home, tuck it away in a nice corner or place it as a side table next to your favourite chair.

25 mm polished marble tabletop with 45 mm border
 Cast iron legs, powder coated
 Dimensions: 33x45 cm (Ø x H)
 Maximum weight load: 30 kg



ZUIVER-CODE	GTIN-CODE	ITEM NAME		
2300087	8718548030251	SIDE TABLE KARRARA GREY		
2300088	8718548030268	SIDE TABLE KARRARA WHITE		
PACKING	1 PCS/CTN			
QTY	CTN SIZE (CM)	CBM	NW (KG)	GW (KG)
1	40x17x44	0,03	8,5	9,5
PRICE (1 PCS)			RETAIL € 95,00	



TIGA NEW

A multifunctional side table! That's what we shouted when Zuiver TIGA was born. It's a set of two small tables. Small, but still rough and tough! TIGA is made out of cast aluminium. A powder coating in matt black and cool grey gives the grained surface an industrial touch.

These two little rascals love to be together, but you can also separate them. Don't worry, you don't have to feel bad about this. They also stand alone well! So, do you already know for what purpose you'd like to use Zuiver's TIGA?

Set of 2 side tables

Cast aluminium, powder coated in grey & black

Dimensions small: 25x45 cm (Ø x H)

Dimensions large: 35x52,5 cm (Ø x H)

Maximum weight load: 50 kg



ZUIVER-CODE	GTIN-CODE	ITEM NAME		
2300091	8718548030473	SIDE TABLE TIGA SET OF 2		
PACKING	1 PCS/CTN (SET OF 2)			
QTY	CTN SIZE (CM)	CBM	NW (KG)	GW (KG)
1 (SET OF 2)	45x45x57	0,115	4,65	7,8
PRICE (1 SET)			RETAIL € 199,00	



FLOW NEW

Nesting tables! Don't you just love them? We do too! Especially these ones, with their oil drop inspired top. All shiny, because of the enamel we used on the metal tabletop. And if you find yourself in a dilemma while choosing, ("Black or blue? Blue or black?") simply decide not to decide at all: They combine sooo nice!

Set of 2 side tables
 Aluminium tabletop with enamel coating
 Cast iron legs, black powder coated
 Dimensions small: 31x40 cm (Ø x H)
 Dimensions large: 40x45 cm (Ø x H)
 Maximum weight load: 20 kg



ZUIVER-CODE	GTIN-CODE	ITEM NAME		
2300089	8718548030459	SIDE TABLE FLOW SET OF 2 BLACK		
2300090	8718548030466	SIDE TABLE FLOW SET OF 2 BLUE		
PACKING	1 PCS/CTN (SET OF 2)			
QTY	CTN SIZE (CM)	CBM	NW (KG)	GW (KG)
1 (SET OF 2)	45x21x45	0,043	4,75	9,1
PRICE (1 SET)			RETAIL € 189,00	



ENAMEL

We were definitely inspired by the fifties when we came up with Enamel. This classic little side table comes in a set of three coordinated colours, also inspired by the era in furniture history. We like to stay in style, you know.

Iron, epoxy coated top

Dimensions:

S: 31x29 cm (Ø x H)

M: 31x40 cm (Ø x H)

L: 31x45 cm (Ø x H)



ZUIVER-CODE	GTIN-CODE	ITEM NAME		
2300025	8718548016323	SIDE TABLE ENAMEL SET OF 3		
PACKING	1 PCS/CTN (SET OF 3)			
QTY	CTN SIZE (CM)	CBM	NW (KG)	GW (KG)
1 (SET OF 3)	59x75x7	0,031	7,4	10,6
PRICE (1 SET)			RETAIL € 169,00	

HANDLE

One can never predict when it comes in handy to carry along ones side table. But we predict, once you own this cute, little Zuiver, you'll realize how handy it is to have: A table with a handle. Brilliant. Just plain, brilliant. Oh, and good looking too, don't you agree?!

18 mm MDF table top with bamboo veneer in natural colour on both sides

15 mm powder coated black steel tube, bended to shape legs and handle

Maximum weight load: 15 kg

Dimensions: 38,5x57 cm (Ø x H)



ZUIVER-CODE	GTIN-CODE	ITEM NAME		
2300040	8718548018952	SIDE TABLE HANDLE BAMBOO BLACK		
PACKING	1 PCS/CTN			
QTY	CTN SIZE (CM)	CBM	NW (KG)	GW (KG)
1	51x42x22	0,047	2,3	3,3
PRICE (1 PCS)			RETAIL € 79,00	



CUPID LARGE & XXL

In The Netherlands we have a saying; 'Small children grow up'. At Zuiver we tend to see our products as our children, therefore it made sense to us to make a 'grown up' version of one of our bestsellers: side table Cupid. Cupid Large and XXL is the result. Feel free to compose your own Cupid family!

Detachable glass table top (copper mirror glass or black low tempered glass)
 Foldable iron frame (10 mm), copper plated or black powder coated
 Maximum weight load: 5 kg
 Dimensions Large: 62,5x40 cm (Ø x H)
 Dimensions XXL: 82,5x35 cm (Ø x H)



ZUIVER-CODE	GTIN-CODE	ITEM NAME			
2300049	8718548023307	SIDE TABLE CUPID LARGE COPPER			
2300051	8715848023758	SIDE TABLE CUPID LARGE BLACK			
PACKING	1 PCS/CTN				
QTY	CTN SIZE (CM)	CBM	NW (KG)	GW (KG)	
1	69x68,5x9,8	0,046	7,2	9	
PRICE COPPER (1 PCS)			RETAIL € 149,00		
PRICE BLACK (1 PCS)			RETAIL € 109,00		

ZUIVER-CODE	GTIN-CODE	ITEM NAME			
2300050	8718548023314	SIDE TABLE CUPID XXL COPPER			
2300052	8718548023765	SIDE TABLE CUPID XXL BLACK			
PACKING	1 PCS/CTN				
QTY	CTN SIZE (CM)	CBM	NW (KG)	GW (KG)	
1	89x88,5x9,8	0,077	10,6	13	
PRICE COPPER (1 PCS)			RETAIL € 239,00		
PRICE BLACK (1 PCS)			RETAIL € 159,00		



CUPID

So, we actually had meetings about Cupid. For we couldn't decide what colour this light weight, yet sturdy, side table had to come in. Copper, silver, gold or black. We even asked our Facebook fans. In the end we decided not to decide at all. We think all our Cupids earn existence.

Black:

Detachable coloured tempered glass table top

Foldable iron frame, powder coated

Copper/silver/gold:

Detachable mirror glass table top

Foldable iron frame, copper/brass plated or chromed

Dimensions: 43x45 cm (Ø x H)

Maximum weight load: 5 kg



ZUIVER-CODE	GTIN-CODE	ITEM NAME		
2300036	8718548017634	SIDE TABLE CUPID BLACK		
2300038	8718548017658	SIDE TABLE CUPID COPPER		
2300039	8718548017665	SIDE TABLE CUPID SILVER		
2300079	8718548026650	SIDE TABLE CUPID GOLD		
PACKING	1 PCS/CTN			
QTY	CTN SIZE (CM)	CBM	NW (KG)	GW (KG)
1	49x48x9,8	0,023	3,84	4,6
PRICE BLACK (1 PCS)			RETAIL € 59,00	
PRICE COPPER/SILVER/GOLD (1 PCS)			RETAIL € 79,00	

Side table Cupid is so versatile in style, decorating options and overall use, that we decided it needed to come in even more finishes. That is also how we keep this Zuiver classic up-to-date with the latest decorating trends. This season our light weight, yet sturdy Cupid comes in copper, silver, gold, black and (whoop-whoop:) two marble-look finishes!



CUPID MARBLE

Detachable table top,
marble laminated & tempered glass
Foldable iron frame, powder coated
Dimensions: 43x45 cm (Ø x H)
Maximum weight load: 5 kg



ZUIVER-CODE	GTIN-CODE	ITEM NAME		
2300080	8718548027619	SIDE TABLE CUPID MARBLE BLACK		
2300081	8718548027626	SIDE TABLE CUPID MARBLE WHITE		
PACKING	1 PCS/CTN			
QTY	CTN SIZE (CM)	CBM	NW (KG)	GW (KG)
1	49x48x9,8	0,023	3,84	4,6
PRICE (1 PCS)			RETAIL € 79,00	

KELLY TRAY

A table with benefits, that is what Kelly Tray is. Her top (yes we decided Kelly Tray is a she) can double as a tray. Ideal for entertaining. All the glasses are transported to the kitchen in just one go.

Steel wire frame and tray, powdercoated
in glossy white or metallic gold
Removable tray for separate use
Dimensions: 50x57 cm (Ø x H)
Maximum weight load: 15 kg



ZUIVER-CODE	GTIN-CODE	ITEM NAME		
2300041	8718548019263	SIDE TABLE KELLY TRAY GOLD		
4001201	8718548005679	SIDE TABLE KELLY TRAY WHITE		
PACKING	1 PCS/CTN			
QTY	CTN SIZE (CM)	CBM	NW (KG)	GW (KG)
1	53,5x53,5x39,5	0,113	5,2	6,7
PRICE (1 PCS)			RETAIL € 129,00	

OSB M&L is completely in sync with the worldwide decorating trend that is inspired by the average construction site. The top is made out of OSB board and we added a stylish touch at the side and underneath. How cool is that?



OSB

18 mm OSB pannel top, natural PU-lacquered
Powder coated, foldable metal legs
Dimensions M: 40x36 cm (Ø x H)
Dimensions L: 60x40 cm (Ø x H)



ZUIVER-CODE	GTIN-CODE	ITEM NAME		
2300031	8718548016804	SIDE TABLE OSB M WHITE		
PACKING	4 PCS/CTN	ORDER QTY: 4 PCS		
QTY	CTN SIZE (CM)	CBM	NW (KG)	GW (KG)
1	41x41x5,8	0,01	2,4	
4	43x43x26,5	0,049	9,6 (4x2,4)	10,7
PRICE (1 PCS)		RETAIL € 49,00		
ZUIVER-CODE	GTIN-CODE	ITEM NAME		
2300034	8718548016835	SIDE TABLE OSB L WHITE		
PACKING	2 PCS/CTN	ORDER QTY: 2 PCS		
QTY	CTN SIZE (CM)	CBM	NW (KG)	GW (KG)
1	61x61x5,8	0,022	4,1	
2	63x63x14,5	0,058	8,2 (2x4,1)	9,7
PRICE (1 PCS)		RETAIL € 59,00		

BEE

We picked up the inspiration for side table Bee during one of our visits to Milan. Matte white combined with solid wood. Somehow it is a soothing, easy on the eye, combo. Which blends into every interior! Bee comes in two sizes. We did that for your convenience. That's just who we are.

MDF matte white table top
Solid birchwood legs
Dimensions small: 45x50 cm (Ø x H)
Dimensions large: 75x50 cm (Ø x H)



ZUIVER-CODE	GTIN-CODE	ITEM NAME		
4001801	8718548005754	SIDE TABLE BEE 45x50		
4001802	8718548005761	SIDE TABLE BEE 75x50		
PACKING	1 PCS/CTN			
SIZE	CTN SIZE (CM)	CBM	NW (KG)	GW (KG)
45x50	54x54x12	0,035	4,9	5,9
75x50	84x84x12	0,085	10,7	12,7
PRICE 45x50 (1 PCS)		RETAIL € 99,00		
PRICE 75x50 (1 PCS)		RETAIL € 139,00		



TWO TONE

Still in doubt about what your side table should look like? Not able to choose between a wooden or a lacquered one? Don't worry, our Two Tone is a combination of both! That's us, we love to keep it as simple as possible for you.

10 mm plywood, basswood veneer top with colour finish
 Rubber wood legs with coloured feet
 Dimensions: 48x47,5 cm (Ø x H)



ZUIVER-CODE	GTIN-CODE	ITEM NAME			
2300004	8718548004405	SIDE TABLE TWO TONE WHITE			
2300007	8718548004436	SIDE TABLE TWO TONE DARK GREY			
PACKING	1 PCS/CTN				
QTY	CTN SIZE (CM)	CBM	NW (KG)	GW (KG)	
1	51x49,5x7	0,018	2,2	2,9	
PRICE (1 PCS)			RETAIL € 79,00		

HIDE & SEEK

Hide & Seek is our answer to ugly, but necessary, small clutter in your interior. Pens, remote controls, mail you don't want to see. Not yet. Side table Hide & Seek will be happy to swallow it. Temporarily. Until you're ready to deal with it. Hide & Seek comes in two neutral colours.

9 & 12 mm MDF top with plywood border
 Total height top: 55 mm; height opening 34 mm
 Rubber wood base
 Dimensions: 46x50 cm (Ø x H)



ZUIVER-CODE	GTIN-CODE	ITEM NAME			
2300021	8718548014749	SIDE TABLE HIDE AND SEEK WHITE			
2300078	8718548026544	SIDE TABLE HIDE AND SEEK GREY			
PACKING	1 PCS/CTN				
QTY	CTN SIZE (CM)	CBM	NW (KG)	GW (KG)	
1	49,5x49,5x10	0,0283	3,5	4,2	
PRICE (1 PCS)			RETAIL € 99,00		



OAK TRAY

Oak Tray is a table with benefits. Not only does the high border keep things from being knocked over, the tabletop also doubles as a tray. Imagine: All those empty glasses and bowls with crumbs can be brought to the kitchen in just one go! But to us that's only one of the reasons to buy it. We just love the look of it! Especially since it comes in two sizes, a higher side table and a full size coffee table, which of course combine beautifully!

Removable tray on frame
 MDF top with plywood border
 Oak veneer, natural colour
 Steel legs, powder coated in black
 Dimensions side table: 46,5x55,5 cm (Ø x H)
 Maximum weight load: 15 kg
 Dimensions coffee table: 78x45 cm (Ø x H)
 Maximum weight load: 35 kg



ZUIVER-CODE	GTIN-CODE	ITEM NAME		
2200009	8718548025004	COFFEE TABLE OAK TRAY		
PACKING	1 PCS/CTN			
QTY	CTN SIZE (CM)	CBM	NW (KG)	GW (KG)
1	84x82x10	0,069	7,2	9
PRICE (1 PCS)		RETAIL € 229,00		

ZUIVER-CODE	GTIN-CODE	ITEM NAME		
2300003	8718548004399	SIDE TABLE OAK TRAY		
PACKING	1 PCS/CTN			
QTY	CTN SIZE (CM)	CBM	NW (KG)	GW (KG)
1	60x52x9,5	0,03	4,8	5,6
PRICE (1 PCS)		RETAIL € 99,00		



TREETOP

Neatly sawn boards of Teak? Boring! Treetop is constructed out of a slab of the teak tree. So no two are alike. We gave this side table metal legs. And then we just stopped meddling with it. Because it was just perfect.

Teak wood top without finish
 Black powder coated metal legs
 Table top: 5 cm
 Dimensions: 30-35x45 cm (Ø x H)



ZUIVER-CODE	GTIN-CODE	ITEM NAME		
2300083	8718548028951	SIDE TABLE TREETOP (kd)		
PACKING	1 PCS/CTN			
QTY	CTN SIZE (CM)	CBM	NW (KG)	GW (KG)
1	46x46x11	0,02	4-5	5-6
PRICE (1 PCS)			RETAIL € 79,00	

ANTIQUE COPPER

So stylish and hip anyone could find a spot at home for Antique Copper. This lovely convex side table can always be right there: at your side. It is of course perfect for an interior with a 'Marrakech theme'. But we believe this side table would feel at ease in any home, no matter what the theme is.

Antique hammered copper
 Dimensions: 37x48 cm (Ø x H)



ZUIVER-CODE	GTIN-CODE	ITEM NAME		
1400023	8718548016361	STOOL ANTIQUE COPPER		
PACKING	1 PCS/CTN			
QTY	CTN SIZE (CM)	CBM	NW (KG)	GW (KG)
1	41x41x52	0,087	3,2	5,7
PRICE (1 PCS)			RETAIL € 109,00	



MOSAIC

The perfect square. That's what Mosaic is to us. Not only because of its obvious shape. But also because of what it was made out of. Mosaic is constructed out of recycled wooden tiles. And exactly that is what gives Mosaic its pretty colour shades.

Recycled teak and acacia wood without finish
 Dimensions: 40x40x40 cm (WxDxH)
 Maximum weight load: 150 kg



ZUIVER-CODE	GTIN-CODE	ITEM NAME		
2400002	8718548004450	DECO TABLE MOSAIC		
PACKING	1 PCS/CTN			
QTY	CTN SIZE (CM)	CBM	NW (KG)	GW (KG)
1	42x42x43	0,08	11,6	12,4
PRICE (1 PCS)			RETAIL € 119,00	

CUMI

We call this baby an 'occasional table'. Why? Well, simple: you can use Cumi at any occasion! The striking legs are composed out of a miniature mangrove of Mango wood. I bet none of your friends can say they have a mango wood piece of furniture. Unless, of course, they beat you to it and got Cumi first!

Particle board, resin glossy white lacquered
 Mango wood branches base without finish
 Dimensions: 45x45 cm (Ø x H)



ZUIVER-CODE	GTIN-CODE	ITEM NAME		
4000615	8718548005594	SIDE TABLE CUMI GLOSSY WHITE		
PACKING	1 PCS/CTN			
QTY	CTN SIZE (CM)	CBM	NW (KG)	GW (KG)
1	47x47x47	0,104	9,5	11
PRICE (1 PCS)			RETAIL € 169,00	



SEATERS





SEATERS

ZUIGER° COLLECTION 2017
NL RETAIL PRICES INCL. VAT



JAEY

Our Zuiver design team, once again, really outdid themselves by designing sofa Jaey. This very feminine lounge set can just as easily stand up to masculine interiors, simply by choosing another fabric. Jaey comes in various sizes to accommodate every lounge area. Go ahead and mix and match sizes and fabric, in other words: have fun with Jaey!

Seat cushions: PU-foam, density 30
 Back cushions: HR PU-foam, density 30
 Frame: pine wood, plywood
 Suspension: no-sag
 Black metal legs

CHOOSE YOUR FABRIC



salmon

SALSA

100% polyester
 Martindale >100.000
 Colour fastness 5

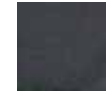

grey/blue 81

COMFORT

100% polypropylene
 Martindale: 50.000
 Colour fastness 4

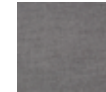

light grey 91

COMFORT

100% polypropylene
 Martindale: 50.000
 Colour fastness 4



grey 67

STONE

100% cotton
 Martindale >30.000
 Colour fastness 5



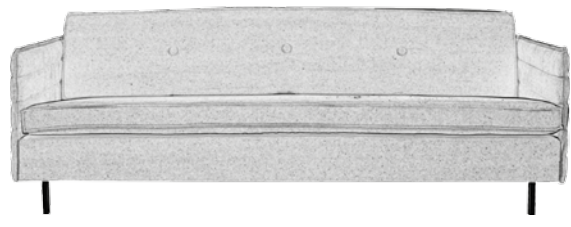

209

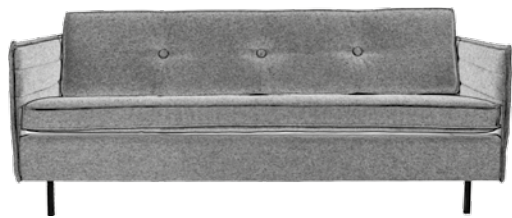

181



72



76 65 50 90 Seat depth: 57,5 cm

3200043	8718548027725	SOFA JAEY 3-SEATER SALSA SALMON		
3200044	8718548027732	SOFA JAEY 3-SEATER COMFORT GREY/BLUE 81		
3200045	8718548027749	SOFA JAEY 3-SEATER COMFORT LIGHT GREY 91		
3200049	8718548027787	SOFA JAEY 3-SEATER STONE GREY 67		
PACKING		1 PCS (mix of carton and plastic)		
QTY	CTN SIZE (CM)	CBM	NW (KG)	GW (KG)
1	211x78x92	1,51	55	58
PRICE (1 PCS)		RETAIL € 1099,00		
3200053	8718548027824	SOFA JAEY 2,5-SEATER SALSA SALMON		
3200054	8718548027831	SOFA JAEY 2,5-SEATER COMFORT GREY/BLUE 81		
3200055	8718548027848	SOFA JAEY 2,5-SEATER COMFORT LIGHT GREY 91		
3200059	8718548027886	SOFA JAEY 2,5-SEATER STONE GREY 67		
PACKING		1 PCS (mix of carton and plastic)		
QTY	CTN SIZE (CM)	CBM	NW (KG)	GW (KG)
1	183x78x92	1,31	48	51
PRICE (1 PCS)		RETAIL € 969,00		
3200063	8718548027923	SOFA JAEY 1-SEATER SALSA SALMON		
3200064	8718548027930	SOFA JAEY 1-SEATER COMFORT GREY/BLUE 81		
3200065	8718548027947	SOFA JAEY 1-SEATER COMFORT LIGHT GREY 91		
3200069	8718548027985	SOFA JAEY 1-SEATER STONE GREY 67		
PACKING		1 PCS (mix of carton and plastic)		
QTY	CTN SIZE (CM)	CBM	NW (KG)	GW (KG)
1	74x78x92	0,53	19	22
PRICE (1 PCS)		RETAIL € 469,00		



FAT FREDDY

Yo, meet Fat Freddy! If Fat Freddy could talk, this would be his slang. Fat Freddy seems simple but is actually as versatile as can be. He comes in several colours and fabrics and is also available in two versions: A left one and a right one. Combine them and puzzle your own lounge area to leap on and sink into, literally! We made the top layer of Fat Freddy's cushions extra soft for your convenience, bro!

Back & seat cushions: PU-foam, density 35 + toplayer of 50% siliconised fiber filling & 50% feathers
 Frame: pine wood, chipboard, hardwood, plywood
 Suspension: no-sag
 50 mm plastic legs
 Depth 3-seater: 103 cm, seat depth 63 cm
 Depth longchair: 188 cm

Choose your fabric on page 52

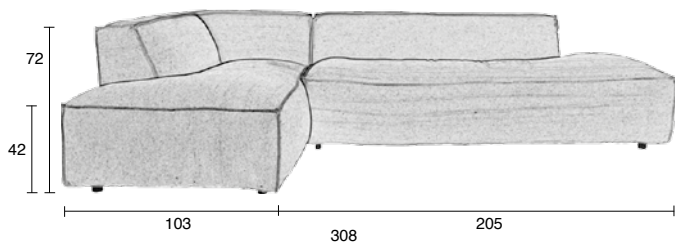

Fat Freddy left
Salsa Salmon



Fat Freddy right
Comfort Grey/Blue 81



Fat Freddy left
Comfort Light Grey 91



Fat Freddy right
Stone Grey 67

3200073	8718548028029	SOFA FAT FREDDY LEFT SALSA SALMON		
3200074	8718548028036	SOFA FAT FREDDY LEFT COMFORT GREY/BLUE 81		
3200075	8718548028043	SOFA FAT FREDDY LEFT COMFORT LIGHT GREY 91		
3200079	8718548028081	SOFA FAT FREDDY LEFT STONE GREY 67		
PACKING	1 PCS/2 CTN (mix of carton and plastic)			
COMPONENT	CTN SIZE (CM)	CBM	NW (KG)	GW (KG)
3-SEATER	207x105x74	1,61	49	52
LONGCHAIR	190x105x74	1,48	48	51
PRICE (1 PCS)				RETAIL € 2399,00

3200083	8718548028326	SOFA FAT FREDDY RIGHT SALSA SALMON		
3200084	8718548028333	SOFA FAT FREDDY RIGHT COMFORT GREY/BLUE 81		
3200085	8718548028340	SOFA FAT FREDDY RIGHT COMFORT LIGHT GREY 91		
3200089	8718548028388	SOFA FAT FREDDY RIGHT STONE GREY 67		
PACKING	1 PCS/2 CTN (mix of carton and plastic)			
COMPONENT	CTN SIZE (CM)	CBM	NW (KG)	GW (KG)
3-SEATER	207x105x74	1,61	49	52
LONGCHAIR	190x105x74	1,48	48	51
PRICE (1 PCS)				RETAIL € 2399,00



JAMES

True, not everyone is a designer. But with our element sofa James you can be one! You can make your James as small or huge as you want. You can choose from several elements in three colours of our signature rib fabric. Wanna be different? Then James is your man! Mix and match elements and colours to create your own ultimate sofa.

Removable cover in ribcord fabric with piping
 Fabric: 88% nylon, 12% polyester, >40.000 Martindale
 Filling: Polyether foam
 Foam density seat 33
 Maximum weight load: 200 kg

ZUIVER-CODE	GTIN-CODE	ITEM NAME		
3200030	8718548021488	ELEMENT SOFA JAMES ARM		
3200031	8718548021495	ELEMENT SOFA JAMES ELEMENT		
3200032	8718548021501	ELEMENT SOFA JAMES CORNER		
3200033	8718548021518	ELEMENT SOFA JAMES HOCKER		
PACKING	1 PCS/CTN			
QTY 1	CTN SIZE (CM)	CBM	NW (KG)	GW (KG)
ARM	79x28x50	0,11	7	8,8
ELEMENT	88x95x42	0,35	21	23,8
CORNER	93x93x70	0,61	23,5	26,5
HOCKER	90x90x38	0,31	18	20,5
PRICE ARM (1 PCS)			RETAIL € 75,00	
PRICE ELEMENT (1 PCS)			RETAIL € 325,00	
PRICE CORNER (1 PCS)			RETAIL € 376,00	
PRICE HOCKER (1 PCS)			RETAIL € 179,00	

Important information for ordering the element cover!
 There are three kinds of covers available:

- * Cover James element open right (for right arm, when standing in front of the element)
- * Cover James element open left (for left arm, when standing in front of the element)
- * Cover James element closed (no arm directly attached)

Which one you have to choose depends on whether you want to attach an arm left or right, or no arm at all.

It's not necessary to order each element separately. For your convenience you can use below Zuiver-codes to order a preconfigured sofa.



sofa james 2-seater cool grey



sofa james 3-seater cool grey



sofa james lounge cool grey



hocker james cool grey

ZUIVER-CODE	GTIN-CODE	ITEM NAME	
3200113	8718548030527	SOFA JAMES 2-SEATER COOL GREY	
3200114	8718548030534	SOFA JAMES 3-SEATER COOL GREY	
3200115	8718548030541	SOFA JAMES LOUNGE COOL GREY	
3300023	8718548030558	HOCKER JAMES COOL GREY	
PRICE 2-SEATER (1 PCS)		RETAIL € 1076,00	
PRICE 3-SEATER (1 PCS)		RETAIL € 1490,00	
PRICE LOUNGE (1 PCS)		RETAIL € 1965,00	
PRICE HOCKER (1 PCS)		RETAIL € 256,00	

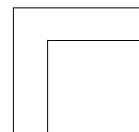

CORNER
 91 x 91 x 74 CM (WxDxH)
 SEAT HEIGHT: 41 CM

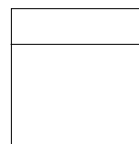

ELEMENT
 86 x 91 x 74 CM (WxDxH)
 SEAT HEIGHT: 41 CM



ARM
 26 x 73 x 53 CM
 (WxDxH)



HOCKER
 86 x 86 x 41 CM
 (WxDxH)



blue

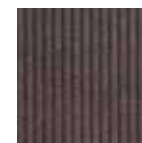

grey



cool grey



Element with arm right

This consists of the following items:

- * Element sofa James element
- * Element sofa James arm
- * Cover James element open **right**
- * Cover James arm

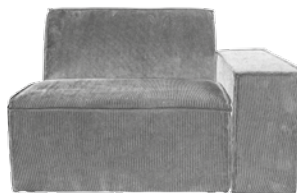

ZUIVER-CODE	GTIN-CODE	ITEM NAME		
3400012	8718548021617	COVER JAMES ELEMENT CLOSED RIB BLUE		
3400013	8718548021624	COVER JAMES ELEMENT CLOSED RIB GREY		
3400014	8718548021631	COVER JAMES ELEMENT CLOSED RIB COOL GREY		
3400018	8718548021679	COVER JAMES ELEMENT OPEN LEFT RIB BLUE		
3400019	8718548021686	COVER JAMES ELEMENT OPEN LEFT RIB GREY		
3400020	8718548021693	COVER JAMES ELEMENT OPEN LEFT RIB COOL GREY		
3400024	8718548021730	COVER JAMES ELEMENT OPEN RIGHT RIB BLUE		
3400025	8718548021747	COVER JAMES ELEMENT OPEN RIGHT RIB GREY		
3400026	8718548021754	COVER JAMES ELEMENT OPEN RIGHT RIB COOL GREY		
PACKING	1 PCS/CTN, 5 PCS/MASTERCTN			
QTY	CTN SIZE (CM)	CBM	NW (KG)	GW (KG)
1	45x36x5,5	0,009	1,26	1,57
5	45x37x29	0,048	7,85	8,56
PRICE COVER ELEMENT (1 PCS)		RETAIL € 89,00		

ZUIVER-CODE	GTIN-CODE	ITEM NAME		
3400006	8718548021556	COVER JAMES ARM RIB BLUE		
3400007	8718548021563	COVER JAMES ARM RIB GREY		
3400008	8718548021570	COVER JAMES ARM RIB COOL GREY		
PACKING	1 PCS/CTN, 5 PCS/MASTERCTN			
QTY	CTN SIZE (CM)	CBM	NW (KG)	GW (KG)
1	40x27x4	0,004	0,47	0,65
5	40x28x22	0,025	3,25	3,7
PRICE COVER ARM (1 PCS)		RETAIL € 49,00		

ZUIVER-CODE	GTIN-CODE	ITEM NAME		
3400030	8718548021792	COVER JAMES CORNER RIB BLUE		
3400031	8718548021808	COVER JAMES CORNER RIB GREY		
3400032	8718548021815	COVER JAMES CORNER RIB COOL GREY		
PACKING	1 PCS/CTN, 5 PCS/MASTERCTN			
QTY	CTN SIZE (CM)	CBM	NW (KG)	GW (KG)
1	45x36x5,5	0,009	1,26	1,57
5	45x37x29	0,048	7,85	8,56
PRICE COVER CORNER (1 PCS)		RETAIL € 99,00		

ZUIVER-CODE	GTIN-CODE	ITEM NAME		
3400036	8718548021853	COVER JAMES HOCKER RIB BLUE		
3400037	8718548021860	COVER JAMES HOCKER RIB GREY		
3400038	8718548021877	COVER JAMES HOCKER RIB COOL GREY		
PACKING	1 PCS/CTN, 5 PCS/MASTERCTN			
QTY	CTN SIZE (CM)	CBM	NW (KG)	GW (KG)
1	45x29x4,5	0,006	0,87	1,11
5	45x30x24	0,32	5,55	6,19
PRICE COVER HOCKER (1 PCS)		RETAIL € 77,00		



DRAGON RIB

Dragon will hold three of your family members comfortably during your typical television evening. Two big comfy cushions to support your back, and we decided to throw in two extra cushions for your arms. Or head. Or feet. Or just to throw to the dog who is trying to steal your popcorn. And if then you unfortunately spill your popcorn on Dragon, don't worry. Just remove the cover and take it to the dry cleaner's.

Removable cover in ribcord fabric (88% nylon, 12% polyester), >40.000 Martindale
 Filling: Polyether foam
 Foam density seat 32, other 26
 Chromed metal base
 2 arm cushions included
 Maximum weight load: 250 kg

ZUIVER-CODE	GTIN-CODE	ITEM NAME		
3200001	8718548005396	SOFA DRAGON 3-SEATER RIB BLUE		
3200004	8718548005426	SOFA DRAGON 3-SEATER RIB GREY		
3200042	8718548025851	SOFA DRAGON COOL GREY		
PACKING	1 PCS			
QTY	PACKING SIZE (CM)	CBM	NW (KG)	GW (KG)
1	ca. 213x95x54, mix carton/plastic	1,09	50	52
PRICE (1 PCS)			RETAIL € 799,00	



blue



cool grey



grey

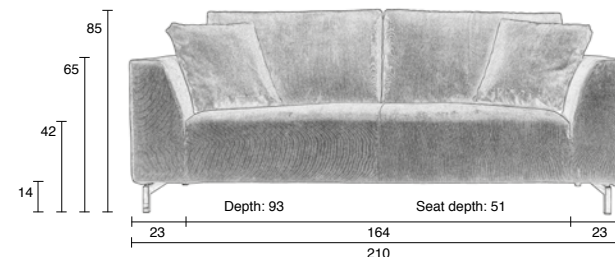



LAZY M NEW

Big on comfort, yet small on taking up space! Next to its stunning looks, that is the main quality of our lounge chair Lazy. This Zuiver design will keep your lounge area spacious while seating your friends, family or yourself. Combine them right next to each other to create a two seater, or keep your distance and just relax by yourself...

Back and seat in diamond stitched fabric with piping
 Fabric: 100% polyester, >25.000 Martindale, colour fastness 5
 Polyester foam filling, density 32
 Solid wood and plywood frame with no-sag springs
 Solid fir wood legs, natural lacquered
 Maximum weight load: 150 kg

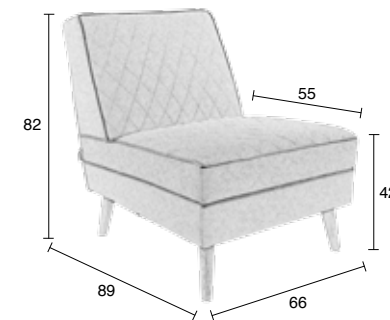

ZUIVER-CODE	GTIN-CODE	ITEM NAME		
3100038	8718548028906	LOUNGE CHAIR LAZY M SKY BLUE		
3100039	8718548028913	LOUNGE CHAIR LAZY M GREY		
PACKING	1 PCS/CTN			
QTY	CTN SIZE (CM)	CBM	NW (KG)	GW (KG)
1	67x78x67 (L-shaped box)	0,29	14,6	17,4
PRICE (1 PCS)			RETAIL € 479,00	



LAZY SACK + HOCKER NEW

Who are you calling fat? We call our Lazy Sack fat. And he is proud of it! Look at that oversized cushioning, those round forms and sink-in-ready comfort. Who wouldn't want to subside into all that luxurious soft material? Check out those baseball bat legs, you just know he is sturdy enough to just dive into. And: there is a footstool too!

You should never judge anything by its size. Same with hocker Lazy Sack. Of course he sort of belongs to the much bigger lounge chair Lazy Sack, but we feel that hocker Lazy Sack has so much going for him that he could also be a standalone! He can be combined with your existing sofa or lazy chair or be a quick seater by himself...

Upholstery in vintage PU-leather,
 >50.000 Martindale, colour fastness 4-5
 PU-foam filling, density 30-35
 Plywood frame
 Solid beech legs, matte black powder coated
 Maximum weight load: 100 kg

ZUIVER-CODE	GTIN-CODE	ITEM NAME			
3100043	8718548031418	LOUNGE CHAIR LAZY SACK			
PACKING	1 PCS/CTN				
QTY	CTN SIZE (CM)	CBM	NW (KG)	GW (KG)	
1	89x77x59	0,404	17,5	20,5	
PRICE (1 PCS)			RETAIL € 679,00		



ZUIVER-CODE	GTIN-CODE	ITEM NAME			
3300024	8718548031487	HOCKER LAZY SACK			
PACKING	1 PCS/CTN				
QTY	CTN SIZE (CM)	CBM	NW (KG)	GW (KG)	
1	81x54x28	0,122	10,5	13,5	
PRICE (1 PCS)			RETAIL € 359,00		





RIDGE LOUNGE RIB

Ridge Lounge Rib is the perfect lounge chair especially if you like yours not to be prominent. The comfortably 'floating' seat and open frame keeps your interior roomy and open enough to add a footstool. So we made you one. Because we would like you to be as comfortable as possible. As you have come to expect from us, Ridge Lounge Rib comes in more than enough colours and the choice is yours: with comfy armrests or without.

Lounge chair and hocker

Chair with or without armrest in bakelite

Back and seat in ribcord fabric with piping

Fabric: 88% nylon, 12% polyester, >40.000 Martindale

Chromed frame with glides

Maximum weight load: 120 kg



ZUIVER-CODE	GTIN-CODE	ITEM NAME		
3100009	8718548005273	LOUNGE CHAIR RIDGE RIB GREY 6A		
3100011	8718548005297	LOUNGE CHAIR RIDGE RIB BLUE 12A		
3100013	8718548005310	LOUNGE CHAIR RIDGE RIB YELLOW 24A		
3100031	8718548026148	LOUNGE CHAIR RIDGE RIB COOL GREY 32A		
PACKING	1 PCS/CTN			
QTY	CTN SIZE (CM)	CBM	NW (KG)	GW (KG)
1	90x80x93	0,670	ca. 12	ca. 14,5
PRICE (1 PCS)			RETAIL € 349,00	

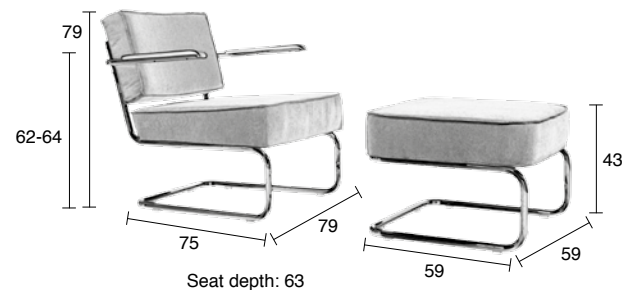

ZUIVER-CODE	GTIN-CODE	ITEM NAME		
3100015	8718548005334	LOUNGE CHAIR RIDGE RIB ARM GREY 6A		
3100017	8718548005358	LOUNGE CHAIR RIDGE RIB ARM BLUE 12A		
3100019	8718548005372	LOUNGE CHAIR RIDGE RIB ARM YELLOW 24A		
3100032	8718548026629	LOUNGE CHAIR RIDGE RIB ARM COOL GREY 32A		
PACKING	1 PCS/CTN			
QTY	CTN SIZE (CM)	CBM	NW (KG)	GW (KG)
1	90x80x93	0,670	ca. 13,5	ca. 16
PRICE (1 PCS)			RETAIL € 399,00	
ZUIVER-CODE	GTIN-CODE	ITEM NAME		
3300002	8718548005471	HOCKER RIDGE RIB GREY 6A		
3300004	8718548005495	HOCKER RIDGE RIB BLUE 12A		
3300006	8718548005518	HOCKER RIDGE RIB YELLOW 24A		
3300022	8718548026926	HOCKER RIDGE RIB COOL GREY 32A		
PACKING	1 PCS/CTN (TOGETHER WITH CHAIR)			
QTY	CTN SIZE (CM)	CBM	NW (KG)	GW (KG)
1	fits in box with chair		ca. 7,7	
PRICE HOCKER (1 PCS)			RETAIL € 199,00	

A comfortable easy chair with an extra cushion for tired and sore backs after a full day at work. Sink into X-Bang and just relax. The chrome frame and the wide seat immediately invite you to jump into it. Want an extra fun fact? The cover is removable. Clever!

X-BANG

Back and seat in ribcord fabric or mixed fabric grey 02
 Ribcord fabric: 88% nylon, 12% polyester, >40.000 Martindale
 Grey 02 fabric: 79% polyester, 21% acryl
 Removable cover
 Foam filling: density 35
 Chromed frame and adjustable feet
 Maximum weight load: 150 kg

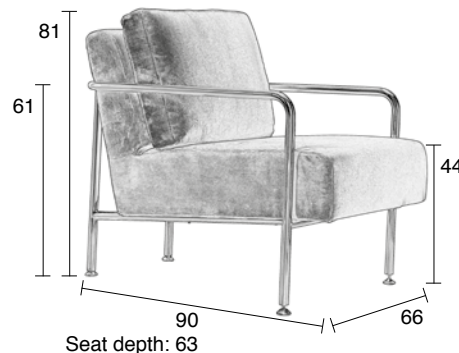

grey 02



blue



cool grey



grey

ZUIVER-CODE	GTIN-CODE	ITEM NAME		
3000509	8718548004870	ARMCHAIR X-BANG GREY 02		
3000524	8718548004917	ARMCHAIR X-BANG RIB BLUE 12A		
3100033	8718548026155	ARMCHAIR X-BANG RIB COOL GREY 32A		
3100034	8718548026162	ARMCHAIR X-BANG RIB GREY 6A		
PACKING	1 PCS/CTN			
QTY	CTN SIZE (CM)	CBM	NW (KG)	GW (KG)
1	90x80x93	0,670	14	15
PRICE (1 PCS)			RETAIL € 349,00	



ADWIN

Adwin is an armchair with fifties class to it. So comfy, ideal to relax and watch your favorite soap, or finally start reading that pile of books that have been waiting for you. The armrests will never chill your bare arms, since we covered the stainless steel there with artificial leather.

Upholstery in black felt-like fabric (55% wool, 45% viscose) or black and white pied de poule (100% cotton)
 Stainles steel frame
 Armrests with strip in black artificial leather
 Maximum weight load: 200 kg

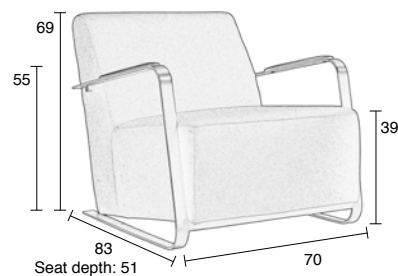

ZUIVER-CODE	GTIN-CODE	ITEM NAME		
3003003	8718548004986	ARMCHAIR ADWIN BLACK&WHITE		
3003004	8718548004993	ARMCHAIR ADWIN FELT BLACK		
PACKING	1 PCS/CTN			
QTY	CTN SIZE (CM)	CBM	NW (KG)	GW (KG)
1	75x86x51/72	0,4	20	24
PRICE (1 PCS)			RETAIL € 449,00	



CABINETS





CABINETS



BARBIER CABINET NEW

Wow, just wow... That's all we could think. Cabinet Barbier left us standing open-mouthed. We just cannot stop staring at this beauty! Look at those vertical lines, which make the cabinet even taller. Two sliding doors reveal three glass shelves, which you can adjust in height. Zuiver Barbier cabinet is big enough to store a lot of stuff. Tableware, books, your booze collection, we can think of dozens of uses for Barbier! You can also leave the doors slightly open and use it as a display cabinet.

18 mm ash veneered MDF top & bottom
 Solid ash wood tambour doors and legs (Ø 45 mm)
 Clear PU-lacquered
 MDF with ash-print foil inside
 Three shelves: 6 mm tempered glass, adjustable in height
 Maximum weight load: 10 kg per glass shelf

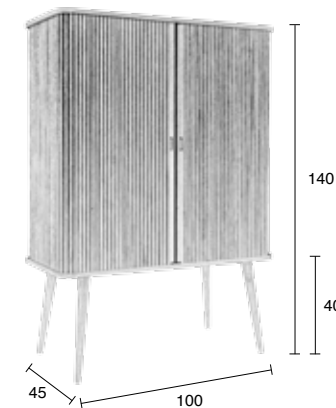

ZUIVER-CODE	GTIN-CODE	ITEM NAME		
4100019	8718548030749	CABINET BARBIER		
PACKING	1 PCS/CTN			
QTY	CTN SIZE (CM)	CBM	NW (KG)	GW (KG)
1	107x52x112	0,62	52	55
PRICE (1 PCS)			RETAIL € 989,00	



BARBIER SIDEBORD NEW

One sideboard, two sliding doors, two glass shelves and a lot of elegance. That's Zuiver Sideboard Barbier in a nutshell. But of course, Barbier is way more than that! It brings warmth and femininity into your interior. Look at the doors with their delicate vertical lines. Slide them back and two compartments arise in which you can store whatever you like. And that includes audio and TV media, because sideboard Barbier has holes in the bottom and back. Very handy, don't you think!?

- 18 mm ash veneered MDF top & bottom
- Solid ash wood tambour doors and legs (Ø 45 mm)
- Clear PU-lacquered
- MDF with ash-print foil inside
- Two shelves: 6 mm tempered glass, adjustable in height
- Cable opening and ventilation hole in both compartments
- Maximum weight load: 10 kg per glass shelf, 40 kg total sideboard

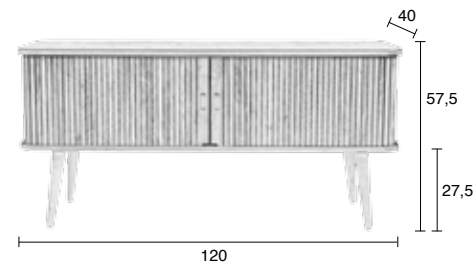

ZUIVER-CODE	GTIN-CODE	ITEM NAME		
4300008	8718548030756	SIDEBORD BARBIER		
PACKING	1 PCS/CTN			
QTY	CTN SIZE (CM)	CBM	NW (KG)	GW (KG)
1	128x49x41	0,26	32	34
PRICE (1 PCS)			RETAIL € 589,00	



BUILD SHELF

Since the invention of the e-reader, some people claim paper books are on the verge of extinction. So what use is there for a new bookcase? Only by looking at our clever Shelf Build one will know the answer to this question. Look at it: It's pretty! It is a modern bookcase perfect for family heirlooms, prized possessions or stray knickknacks. And well yes, also books...

15 mm MDF shelves
 28 mm pine wood legs
 White NC-lacquered
 Maximum weight load per shelf: 30 kg

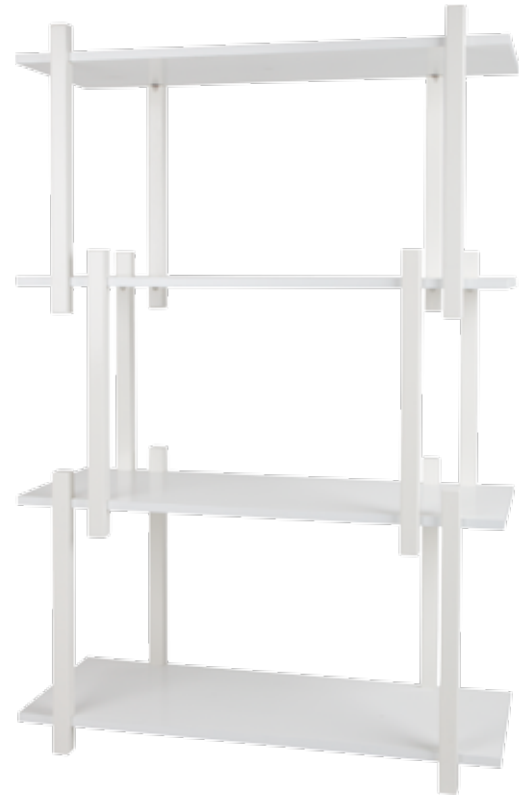

ZUIVER-CODE	GTIN-CODE	ITEM NAME		
4200002	8718548024861	SHELF BUILD THREE		
4200003	8718548024878	SHELF BUILD FOUR		
4200004	8718548024885	SHELF BUILD FIVE		
PACKING	1 PCS/CTN			
TYPE	CTN SIZE (CM)	CBM	NW (KG)	GW (KG)
BUILD THREE	88x38x11	0,037	9	10
BUILD FOUR	88x38x15,5	0,052	13	14,2
BUILD FIVE	88x38x17	0,057	16,5	17,8
PRICE BUILD THREE (1 PCS)			RETAIL € 139,00	
PRICE BUILD FOUR (1 PCS)			RETAIL € 169,00	
PRICE BUILD FIVE (1 PCS)			RETAIL € 199,00	

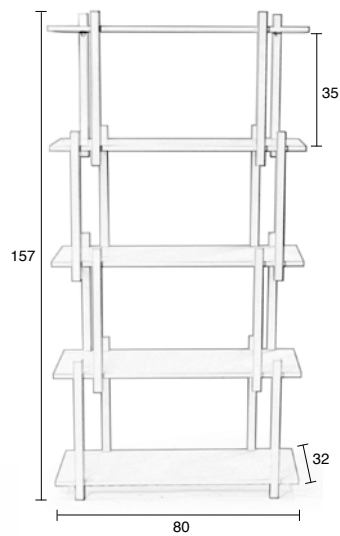
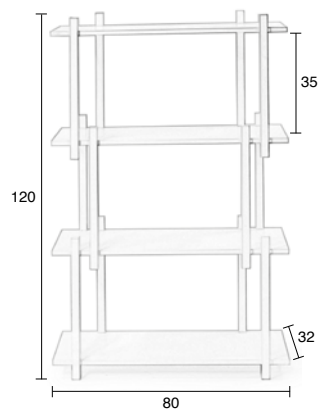
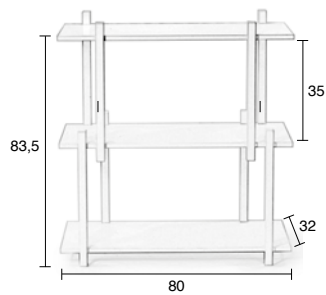

CABINETS



HIGH ON WOOD BOOKSHELF

Make your books fly. With super thin shelves in our High on Wood bookcase, your literature seems to float in between the solid oak frame. We can hardly stop raving about this fantastic combination of classic, heavy oak and the huge contrast with sleek, glossy, super modern MDF.

Solid oak legs with MDF shelves
 Glossy white PU-lacquered
 Maximum weight load per shelf: 12 kg

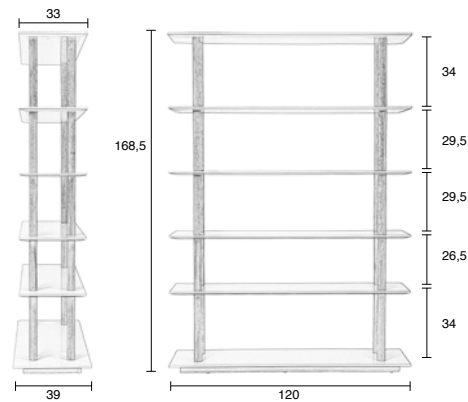

ZUIVER-CODE	GTIN-CODE	ITEM NAME		
4100000	8718548013261	BOOKSHELF HIGH ON WOOD		
PACKING	1 PCS/CTN			
QTY	CTN SIZE (CM)	CBM	NW (KG)	GW (KG)
1	135x49x26	0,172	40	44,5
PRICE (1 PCS)			RETAIL € 479,00	

We can hardly stop raving about this fantastic combination of classic, heavy oak and the huge contrast with sleek, glossy, super modern MDF. Our High on Wood cabinet will hold everything you don't want to reveal to the world. And, we dare to say, it does so in a very hip way.



HIGH ON WOOD 2DR 2DO

2 doors, 2 drawers
Solid oak base
Glossy white PU-lacquered MDF cabinet



ZUIVER-CODE	GTIN-CODE	ITEM NAME		
4100004	8718548018686	CABINET HIGH ON WOOD 2 DRAWERS 2 DOORS (1 CTN)		
PACKING	1 PCS/CTN			
QTY	CTN SIZE (CM)	CBM	NW (KG)	GW (KG)
1	174x50x22	0,18	48	50
PRICE (1 PCS)			RETAIL € 549,00	

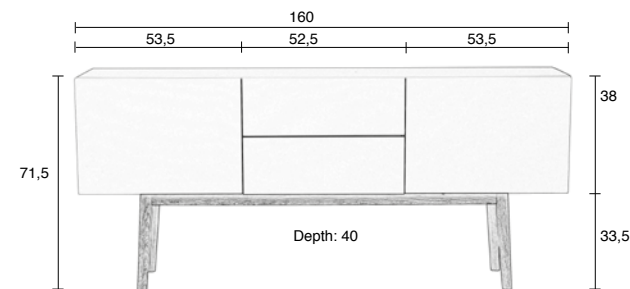



HIGH ON WOOD 2DR 1DO

2 drawers, 1 door
 Solid oak base
 Glossy white PU-lacquered MDF cabinet

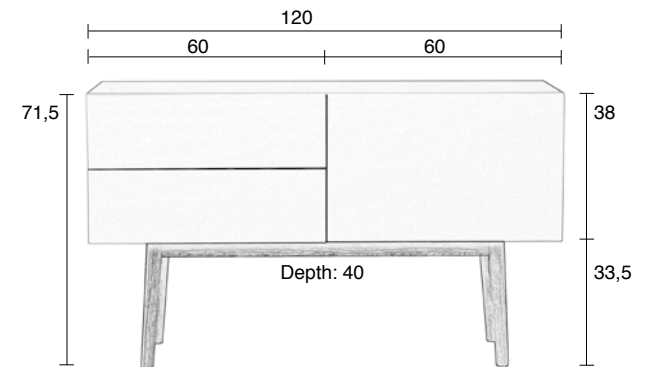

ZUIVER-CODE	GTIN-CODE	ITEM NAME		
4100005	8718548018693	CABINET HIGH ON WOOD 2 DRAWERS 1DOOR (1 CTN)		
PACKING	1 PCS/CTN			
QTY	CTN SIZE (CM)	CBM	NW (KG)	GW (KG)
1	133x50x22	0,14	37	39
PRICE (1 PCS)			RETAIL € 399,00	



HIGH ON WOOD 2DO

2 doors
 Solid oak base
 Glossy white PU-lacquered MDF cabinet

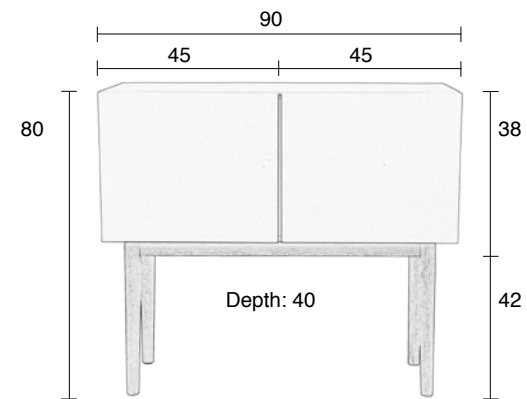

ZUIVER-CODE	GTIN-CODE	ITEM NAME		
4100006	8718548018709	CABINET HIGH ON WOOD 2 DOORS (1CTN)		
PACKING	1 PCS/CTN			
QTY	CTN SIZE (CM)	CBM	NW (KG)	GW (KG)
1	104x50x23	0,11	26	28
PRICE (1 PCS)			RETAIL € 349,00	



CARPETS





CARPETS



MARVEL NEW

Oriental rugs never cease to inspire us. We love Persian motifs on carpets with a vintage look and a distressed patina. Ours are made super soft to the touch and Marvel here even has a nice coloured fringe along its short sides. You see, it's all in the details... That is why Marvel is available in three different colours and two sizes...!

Machine-woven carpet with fringes
 Pile: 66% rayon, 25% cotton, 9% polyester
 Synthetic rubber backing, anti slip

2 sizes:

- 170x240 cm (WxL)
- 200x300 cm (WxL)

Height: 5,5 mm

ZUIVER-CODE	GTIN-CODE	ITEM NAME		
6000073	8718548030565	CARPET MARVEL 170X240 BUTTER		
6000074	8718548030572	CARPET MARVEL 170X240 NEPTUNE		
6000075	8718548030589	CARPET MARVEL 170X240 MOUSE		
6000076	8718548030596	CARPET MARVEL 200X300 BUTTER		
6000077	8718548030602	CARPET MARVEL 200X300 NEPTUNE		
6000078	8718548030619	CARPET MARVEL 200X300 MOUSE		
PACKING	1 PCS			
SIZE	PACKING SIZE (CM)	CBM	NW (KG)	GW (KG)
170X240	182 length X Ø 13,5	0,026	5,2	5,3
200X300	206 length X Ø 15	0,036	7,9	8
PRICE 170X240X0,55 (1 PCS)			RETAIL € 299,00	
PRICE 200X300X0,55 (1 PCS)			RETAIL € 429,00	



butter

neptune

mouse

Note: This carpet has a soft pile. It can assume darker or lighter shades when it is walked on or vacuum cleaned. Colour variations may also appear when viewing the rug from different angles.



MAGIC NEW

You thought Aladdin had a magic carpet? What about the Zuiver version?! We made our Carpet Magic extra special, because we trained it! This is why we can guarantee you that it will stay in place wherever you put it. Oh yes, we are busy getting the patent on that. In the meantime, Magic is available in several colours and sizes...

Machine woven carpet

Pile: 60% heat-set polypropylene, 40% polyester

Back finished with jute

2 sizes:

- 160x230 cm (WxL)
- 200x290 cm (WxL)

Height: 9,5 mm

ZUIVER-CODE	GTIN-CODE	ITEM NAME		
6000067	8718548030138	CARPET MAGIC 160X230 OCEAN		
6000068	8718548030145	CARPET MAGIC 160X230 SUNRISE		
6000069	8718548030152	CARPET MAGIC 160X230 AUTUMN		
6000070	8718548030169	CARPET MAGIC 200X290 OCEAN		
6000071	8718548030176	CARPET MAGIC 200X290 SUNRISE		
6000072	8718548030183	CARPET MAGIC 200X290 AUTUMN		
PACKING	1 PCS			
SIZE	PACKING SIZE (CM)	CBM	NW (KG)	GW (KG)
160x230	180 length x Ø 23	0,075	10,3	10,6
200x290	220 length x Ø 25	0,108	16,24	16,75
PRICE 160X230X1 (1 PCS)			RETAIL € 349,00	
PRICE 200X290X1 (1 PCS)			RETAIL € 539,00	



Note: This carpet has a soft pile. It can assume darker or lighter shades when it is walked on or vacuum cleaned. Colour variations may also appear when viewing the rug from different angles.



CARPET YENGA

NEW

What we see in Carpet Yenga? Oh, boy, that's a lot. Let's give it a go... We see all kinds of shapes: squares, hexagons, diamonds. But the next time we see flowers and different colours from every angle! Yenga just seems to be different every time we look at it. Do you think it's weird that we compare Yenga with a kaleidoscope?!

Yenga is the latest addition to our Zuiver carpet collection. Look at the woven edge on both short sides. First time we've ever added such a refined detail to one of our carpets!

Machine woven carpet
 Pile: 60% heat-set polypropylene, 40% polyester
 Back finished with jute
 Dimensions: 160x230 cm (WxL)
 Height: 9,5 mm

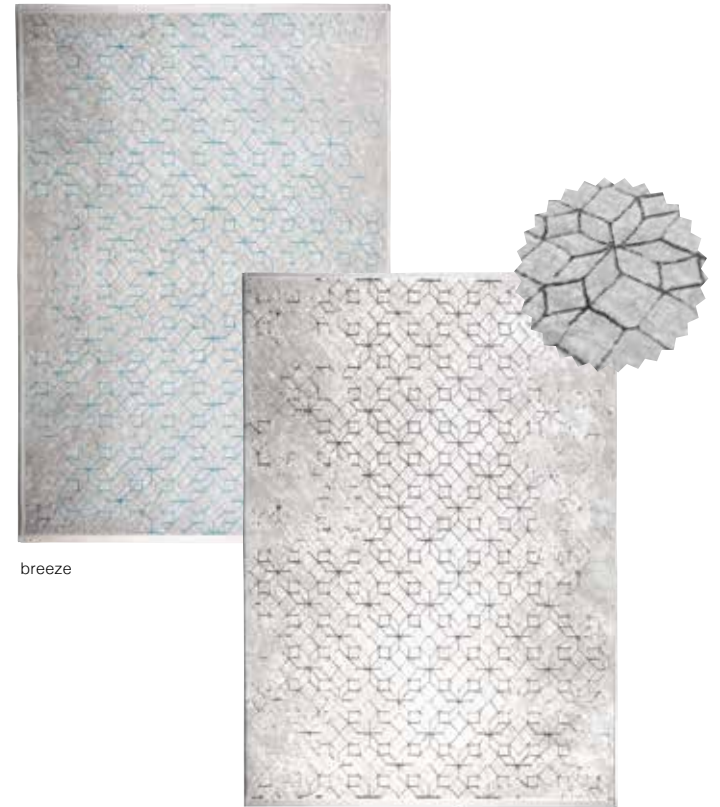

breeze

dusk

ZUIVER-CODE	GTIN-CODE	ITEM NAME		
6000081	8718548031692	CARPET YENGA 160X230 BREEZE		
6000082	8718548031708	CARPET YENGA 160X230 DUSK		
PACKING	1 PCS			
SIZE	PACKING SIZE (CM)	CBM	NW (KG)	GW (KG)
160x230	180 length x Ø 23	0,075	10,3	10,6
PRICE (1 PCS)		RETAIL € 349,00		

Note: This carpet has a soft pile. It can assume darker or lighter shades when it is walked on or vacuum cleaned. Colour variations may also appear when viewing the rug from different angles.



MOOSE

Carpet Moose is a special carpet. Not only because of the patterns, inspired by the famous Norwegian sweater. No, there are more reasons. Tell us, how many carpets have a brother from-an-other-mother? He is called Pillow Moose. Yup, we did it. We just had to use this comfy wool-cotton mix with its pretty woven pattern in more than one design. Besides, think how well styled your house will look when your throw pillow and carpet match? Smashing!

Hand-woven carpet with black cotton fringes
 50% wool, 30% recycled silk, 20% cotton
 Dimensions: 80x200 cm (WxL)
 Height: 6 mm

ZUIVER-CODE	GTIN-CODE	ITEM NAME		
6000066	8718548024670	CARPET MOOSE 80x200		
PACKING	4 PCS/CTN	ORDER QTY: 4 PCS		
QTY	CTN SIZE (CM)	CBM	NW (KG)	GW (KG)
1	61x46x7,62	0,021	2,7	2,73
4	61x46x30,5	0,085	10,8	12,3
PRICE (1 PCS)		RETAIL € 159,00		





SALMON

We at Zuiver have a soft spot for Scandinavian patterns. Patterns like the ones on the famous Norwegian sweaters. We have finally found a way to incorporate them into our interiors: with Carpet Salmon. A nice wool-cotton mix, Soft to the touch and warm to the feet. Such a pretty woven fabric, we just had to use it in a runner and a pillow. Of course they can be bought separately, but imagine how well-balanced your interior will be when your rug and pillow match....!

Hand-woven carpet with black cotton fringes
 80% wool, 20% cotton
 Dimensions: 80x200 cm (WxL)
 Height: 6 mm

ZUIVER-CODE	GTIN-CODE	ITEM NAME		
6000064	8718548024632	CARPET SALMON 80x200		
PACKING	4 PCS/CTN	ORDER QTY: 4 PCS		
QTY	CTN SIZE (CM)	CBM	NW (KG)	GW (KG)
1	61x46x6,35	0,018	1,9	1,93
4	61x46x25,4	0,071	7,6	9,1
PRICE (1 PCS)		RETAIL € 159,00		





FOX

The most powerful geometric designs are often set in just two colours: black and white. Just like the patterns from a classic Norwegian sweater. Carpet Fox proves the power of black and white patterns once again. Just like your favorite sweater, Fox is made from a nice blend of wool and cotton. With its rectangular shape Carpet Fox is capable to style up any interior!

Hand-woven carpet with black cotton fringes
 80% wool, 20% cotton
 Dimensions: 80x200 cm (WxL)
 Height: 6 mm

ZUIVER-CODE	GTIN-CODE	ITEM NAME		
6000065	8718548024656	CARPET FOX 80x200		
PACKING	4 PCS/CTN	ORDER QTY: 4 PCS		
QTY	CTN SIZE (CM)	CBM	NW (KG)	GW (KG)
1	61x46x5	0,014	2,9	2,93
4	61x46x20	0,056	11,6	13,1
PRICE (1 PCS)			RETAIL € 159,00	





GRAPHIC

There is something about graphic patterns. Wisely used they can be the most subtle home decoration. Unwisely used they can add psychedelic assets to your interior. So, basically, you can never go wrong. Especially not with our easy going Carpet Graphic. We embellished it with a black fringe for that extra oomph factor. Looking at the result we just couldn't stop. We wanted more. Therefore, we added a matching pillow. Pillow Graphic for the ultimate finishing touch. Needless to say they match perfectly and are made out of 100 percent cotton.

Hand-woven carpet with printed dessin
 With black cotton tassels
 100% cotton
 Dimensions: 120x180 cm (WxL)
 Height: 3 mm



ZUIVER-CODE	GTIN-CODE	ITEM NAME		
6000047	8718548023659	CARPET GRAPHIC 120x180 BLACK		
PACKING	4 PCS/CTN	ORDER QTY: 4 PCS		
QTY	CTN SIZE (CM)	CBM	NW (KG)	GW (KG)
4	70x50x12	0,042	8,48 (4x2,12)	9,1
PRICE (1 PCS)		RETAIL € 125,00		



ZIGGY

Let's zigzag your interior! Patterns are hip and plain beautiful. The strong black zigzag pattern on our Carpet Ziggy contrasts beautifully with its light background. This strong graphic pattern is simple yet has enough character to add the finishing touch to any room.

To complete the look we also made Pillow Ziggy with playful embellishments on the seams, pompons in yellow or black. Combine Rug and Pillow Ziggy with our Pillow Graphic to add even more comfort and patterned style to your room.

Hand-woven carpet
 With black cotton tassels
 100% cotton
 Dimensions: 120x180 cm (WxL)
 Height: 3 mm

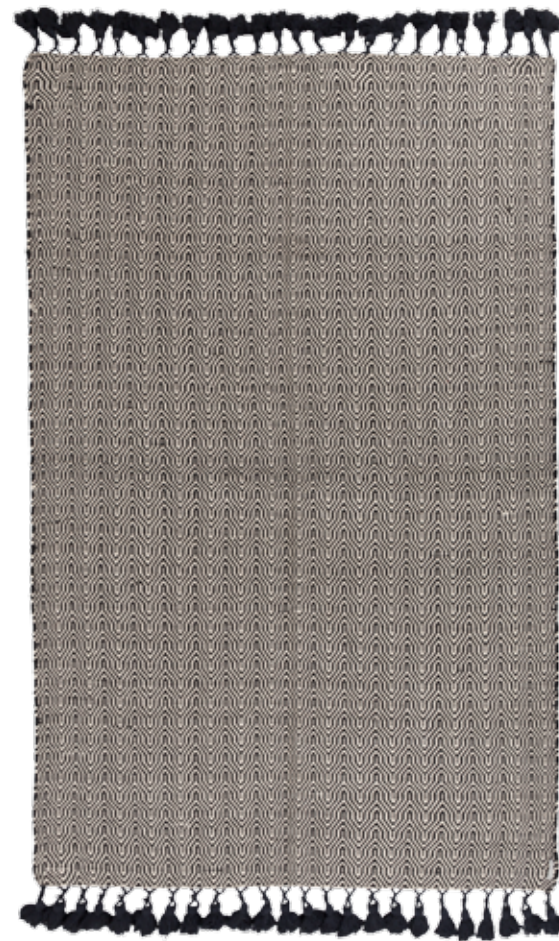

ZUIVER-CODE	GTIN-CODE	ITEM NAME		
6000048	8718548023710	CARPET ZIGGY 120x180 BLACK		
PACKING	4 PCS/CTN	ORDER QTY: 4 PCS		
QTY	CTN SIZE (CM)	CBM	NW (KG)	GW (KG)
4	70x50x12	0,042	14 (4x3,5)	15
PRICE (1 PCS)		RETAIL € 125,00		



PURE

We like colours in the mix. That's what we were looking for in our Pure carpet. Various shades of black, grey and beige. Lively and real, like the wool it is made from. Far from boring! Pure comes in two different sizes and three different colours. It can be used in every room in your house, from study to living, from bedroom to guest room. So what are you waiting for?

Hand-woven carpet
 80% wool felt, 20% sisal

- 160x230 cm (WxL)
- 200x300 cm (WxL)

Height: 10 mm

ZUIVER-CODE	GTIN-CODE	ITEM NAME		
6000041	8718548020580	CARPET PURE 160x230 NATURAL		
6000042	8718548020597	CARPET PURE 160x230 LIGHT GREY		
6000043	8718548020603	CARPET PURE 160x230 DARK GREY		
6000044	8718548020610	CARPET PURE 200x300 NATURAL		
6000045	8718548020627	CARPET PURE 200x300 LIGHT GREY		
6000046	8718548020634	CARPET PURE 200x300 DARK GREY		
PACKING	1 PCS			
SIZE	PACKING SIZE (CM)	CBM	NW (KG)	GW (KG)
160x230	170 length x Ø 19	0,06	8	8,1
200x300	210 length x Ø 22	0,09	13	13,1
PRICE 160X230 (1 PCS)			RETAIL € 499,00	
PRICE 200X300 (1 PCS)			RETAIL € 799,00	





BARLETTA

Cold feet? Try our Barletta by Zuiver. It works! Made from 100% wool and available in several warm colours. With Barletta in your lounge area, your feet will never be cold again. Barletta has a slightly rugged look but is ultimately soft and comfy.

On top of that, this rug comes in two generous and very comfortable sizes.

Hand-woven carpet

100% wool

2 sizes:

- 160x230 cm (WxL)
- 200x300 cm (WxL)

Height: 13 mm



castle wall

steel grey

oyster

ZUIVER-CODE	GTIN-CODE	ITEM NAME		
6000034	8718548020252	CARPET BARLETTA 160X230 CASTLE WALL		
6000035	8718548020269	CARPET BARLETTA 160X230 STEEL GREY		
6000036	8718548020276	CARPET BARLETTA 160X230 OYSTER		
6000037	8718548020283	CARPET BARLETTA 200X300 CASTLE WALL		
6000038	8718548020290	CARPET BARLETTA 200X300 STEEL GREY		
6000039	8718548020306	CARPET BARLETTA 200X300 OYSTER		
PACKING	1 PCS			
SIZE	PACKING SIZE (CM)	CBM	NW (KG)	GW (KG)
160x230	163 length x Ø 20	0,0652	12,3	12,6
200x300	202 length x Ø 23	0,1069	22,9	23,4
PRICE 160X230 (1 PCS)			RETAIL € 349,00	
PRICE 200X300 (1 PCS)			RETAIL € 539,00	



NEPAL

A carpet with a little nostalgic feel to it. That's what our Zuiver Nepal carpet is to us. A modern way to create a warm interior and feet, with a classic touch. Nepal comes in two different shades and three different sizes, among which a wonderful hall runner!

Machine woven carpet with decorative fringes
 Pile: Heat-set polypropylene Decolan and viscose,
 for a wool-like appearance with a silky shine
 950.000 points/sqm

3 sizes:

- 67x245 cm (WxL)
- 160x235 cm (WxL)
- 200x295 cm (WxL)

Height: 11 mm

ZUIVER-CODE	GTIN-CODE	ITEM NAME		
6000005	8718548019003	CARPET NEPAL 67X245 LIGHT		
6000006	8718548019010	CARPET NEPAL 160X235 LIGHT		
6000007	8718548019027	CARPET NEPAL 200X295 LIGHT		
6000008	8718548019034	CARPET NEPAL 67X245 DARK		
6000009	8718548019041	CARPET NEPAL 160X235 DARK		
6000010	8718548019058	CARPET NEPAL 200X295 DARK		
PACKING	1 PCS			
SIZE	PACKING SIZE (CM)	CBM	NW (KG)	GW (KG)
67x245	82 length x Ø 20	0,02	4,678	4,72
160x235	175 length x Ø 23	0,05	10,72	10,8
200x295	220 length x Ø 25	0,09	16,82	16,86
PRICE 67X245 (1 PCS)			RETAIL € 129,00	
PRICE 160X235 (1 PCS)			RETAIL € 299,00	
PRICE 200X295 (1 PCS)			RETAIL € 449,00	



light

dark



POLAR

Polar is so versatile it can be the right carpet for the whole family. Grandmas new flat, your brothers cool dandy apartment, the families second home in the mountains or simply your own home. That hint of a classic print makes it work in any classic house, while the modern worn look makes a contemporary apartment rock. Polar comes in two sizes.

Machine woven carpet with decorative fringes
 Pile: Sorona® yarn, a innovative and sustainable fibre
 250.000 points/sqm

2 sizes:

- 160x235 cm (WxL)
- 200x295 cm (WxL)

Height: 13 mm

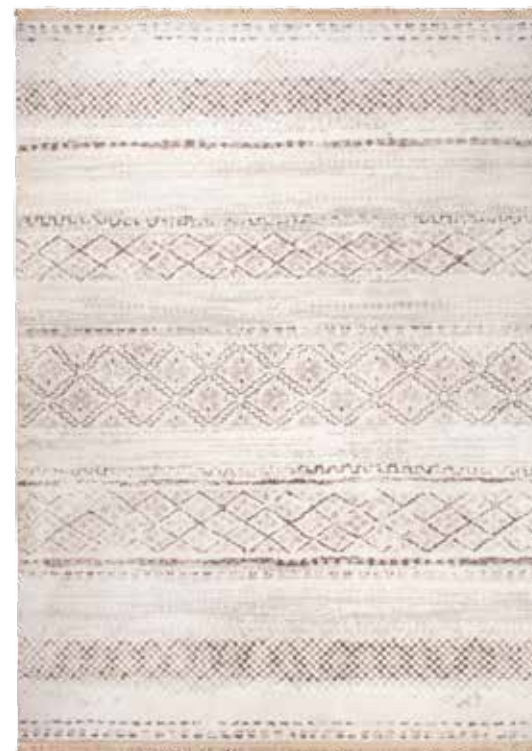

ZUIVER-CODE	GTIN-CODE	ITEM NAME		
6000011	8718548019065	CARPET POLAR 160X235 WHITE		
6000012	8718548019072	CARPET POLAR 200X295 WHITE		
PACKING	1 PCS			
SIZE	PACKING SIZE (CM)	CBM	NW (KG)	GW (KG)
160x235	180 length x Ø 23	0,05	9,568	9,76
200x295	220 length x Ø 25	0,09	15,08	15,38
PRICE 160X235 (1 PCS)			RETAIL € 439,00	
PRICE 200X295 (1 PCS)			RETAIL € 659,00	



NORWAY

Picture yourself in a Norwegian winter. In front of the fireplace. Curled up on a comfortable warm, and yes, fantastic looking, hand-knotted carpet. It must be our Norway. But don't let us, or its name fool you, Norway can be used legally outside Scandinavia as well! And because we feel a carpet like this can hardly ever be too big, we also make it in a respectable XL size.

Hand-knotted carpet

100% wool

2 sizes:

- 170x240 cm (WxL)
- 200x300 cm (WxL)

Height: 22 mm



beige



blue

ZUIVER-CODE	GTIN-CODE	ITEM NAME		
6001000	8718548007437	CARPET NORWAY 170x240 BEIGE		
6001001	8718548007444	CARPET NORWAY 200x300 BEIGE		
6001002	8718548007451	CARPET NORWAY 170x240 BLUE		
6001003	8718548007468	CARPET NORWAY 200x300 BLUE		
PACKING	1 PCS			
SIZE	PACKING SIZE (CM)	CBM	NW (KG)	GW (KG)
170x240	170 length x Ø 25; 3,7 kg/m ²	0,106	15,09	ca. 16
200x300	200 length x Ø 29; 3,7 kg/m ²	0,168	22,2	ca. 23
PRICE 170X240 (1 PCS)			RETAIL € 799,00	
PRICE 200X300 (1 PCS)			RETAIL € 1199,00	



NIENKE

Why not? A braided carpet. We think it looks smashing and utterly original. Nienke is made out of a 100 percent wool felt. And the good thing is Nienke comes in several colours and two sizes.

Hand-knotted carpet
100% wool felt
2 sizes:

- 160x235 cm (WxL)
- 200x295 cm (WxL)

Height: 35 mm

ZUIVER-CODE	GTIN-CODE	ITEM NAME			
6000801	8718548007239	CARPET NIENKE 170x240 IVORY			
6000802	8718548007246	CARPET NIENKE 170x240 LIGHT GREY			
6000803	8718548007253	CARPET NIENKE 170x240 TAUPE			
6000804	8718548007260	CARPET NIENKE 170x240 ANTHRACITE			
6000807	8718548007291	CARPET NIENKE 200x300 IVORY			
6000808	8718548007307	CARPET NIENKE 200x300 LIGHT GREY			
6000809	8718548007314	CARPET NIENKE 200x300 TAUPE			
6000810	8718548007321	CARPET NIENKE 200x300 ANTHRACITE			
PACKING	1 PCS				
SIZE	PACKING SIZE (CM)	CBM	NW (KG)	GW (KG)	
170x240	170 length x Ø 28; 4,25 kg/m ²	0,133	17,34	ca. 18	
200x300	200 length x Ø 35; 4,25 kg/m ²	0,245	25,5	ca. 26	
PRICE 170X240 (1 PCS)			RETAIL € 799,00		
PRICE 200X300 (1 PCS)			RETAIL € 1199,00		



ivory



light grey



taupe



anthracite



LIGHTING





LIGHTING



METAL BOW

Copper/brass plated metal shade and body
 Marble base with copper/brass plated metal cover
 Black PVC cable with foot on/off switch
 Dimensions shade: 32x20 cm (Ø x H)
 Dimensions base: Ø 39 cm
 Light source: E27, max. 60 watt regular bulb,
 max. 20 watt savings, max. 8 watt LED
 Energy efficiency class: A++ - E (Energylabel 1)

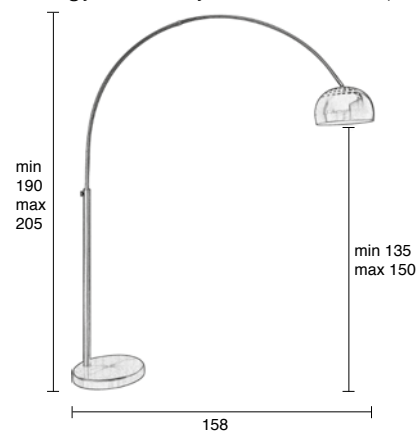

ZUIVER-CODE	GTIN-CODE	ITEM NAME		
5100022	8718548018143	FLOOR LAMP METAL BOW COPPER		
5100047	8718548025899	FLOOR LAMP METAL BOW BRASS		
PACKING	1 PCS/3 CTN			
COMPONENT	CTN SIZE (CM)	CBM	NW (KG)	GW (KG)
SHADE	36,5x36,5x19	0,025	1,1	1,7
BODY	122x27,5x8,5	0,029	2,3	2,9
BASE	45x45x12	0,024	15,7	16,4
PRICE (1 PCS)				RETAIL € 219,00

Warm metal finishes, like copper and brass are hot! So is our Metal Bow. So it made sense to us to bring them together. Hence the Metal Bow Copper and introducing (drumroll...) Metal Bow Brass. Obviously we are very excited about the outcome. Actually, we don't think we need to even explain why. Just look at them! Wow.....



TORCH

The force of uplighters is often underestimated in the world of light fixtures. Let us reveal an interior decorating trick to you: Uplighters brighten up the part of the room that usually doesn't get the spotlight: The ceiling. This gives an immediate feel of space to even the smallest room. And in an ultra hip copper-look, like Torch here, this uplighter will become your super hero.

Iron body, copper plated or white coated with a part of solid oak
 Shade with acrylic plate
 Black PVC cable with foot on/off switch
 Light source: E27, max. 15 watt savings
 Energy efficiency class: A++ - E (Energylabel 1)

ZUIVER-CODE	GTIN-CODE	ITEM NAME		
5100023	8718548018662	FLOOR LAMP TORCH WHITE		
5100024	8718548018679	FLOOR LAMP TORCH COPPER		
PACKING	1 PCS/CTN			
QTY	CTN SIZE (CM)	CBM	NW (KG)	GW (KG)
1	64x26x29	0,057	3,6	5
PRICE WHITE (1 PCS)			RETAIL € 169,00	
PRICE COPPER (1 PCS)			RETAIL € 189,00	

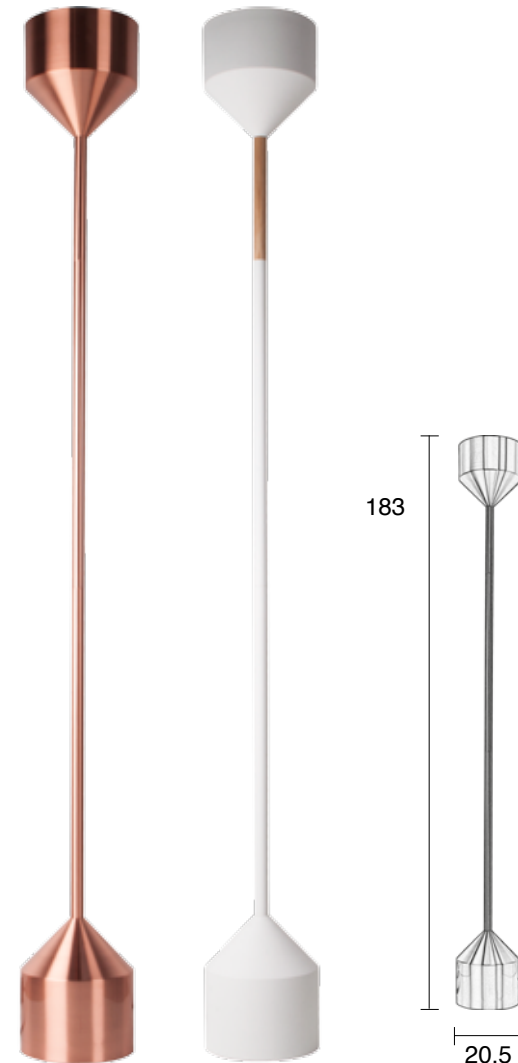



BUCKLE HEAD

Sometimes the simplest designs are the best. Buckle Head is a modest, simple floor lamp. Compatible with practically every interior style. Buckle Head comes in three colours.

- Tiltable metal shade
- Metal body and base
- Black/white textured finish or copper plated
- Black/white: Black and white textured cable with foot on/off switch
- Copper: black PVC cable with foot on/off switch
- Dimensions shade: 21x18,5 cm (Ø x H)
- Dimensions base: 28x3 cm (Ø x H)
- Light source: E27, max. 60 watt regular bulb, max. 20 watt savings, max. 8 watt LED
- Energy efficiency class: A++ - E (Energylabel 1)

ZUIVER-CODE	GTIN-CODE	ITEM NAME		
5002038	8718548006324	FLOOR LAMP BUCKLE HEAD BLACK		
5002039	8718548006331	FLOOR LAMP BUCKLE HEAD WHITE		
5100048	8718548025905	FLOOR LAMP BUCKLE HEAD COPPER		
PACKING	1 PCS/CTN			
QTY	CTN SIZE (CM)	CBM	NW (KG)	GW (KG)
1	56,5x35x24	0,047	6,7	7,8
PRICE BLACK/WHITE (1 PCS)			RETAIL € 109,00	
PRICE COPPER (1 PCS)			RETAIL € 129,00	

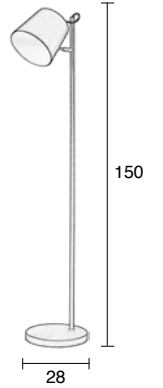



ARC

There is definitely something aerodynamic about Arc with its asymmetric shade. This super tall, yet elegant, floor lamp is an eye catcher in even the wildest interiors. She can light your coffee table from above, without dangling from the ceiling. Which would be lame and would require wiring exactly above your table. And you know those wires are seldom where you need them to be!

Asymmetric polyester textile shade
 Colour coated metal body and base
 PVC cable with foot on/off switch
 Dimensions shade: 40/60x25 cm (Ø x H)
 Dimensions base: 40x2,6 cm (Ø x H)
 Light source: E27, max. 32 watt savings
 Energy efficiency class: A++ - E (Energylabel 1)



ZUIVER-CODE	GTIN-CODE	ITEM NAME		
5000855	8718548005884	FLOOR LAMP ARC BLACK		
5000856	8718548005891	FLOOR LAMP ARC WHITE		
PACKING	1 PCS/2 CTN			
COMPONENT	CTN SIZE (CM)	CBM	NW (KG)	GW (KG)
SHADE	63x63x30	0,119	0,76	2,6
BODY	52,5x13x142,5	0,097	15,3	18,5
PRICE (1 PCS)				RETAIL € 259,00

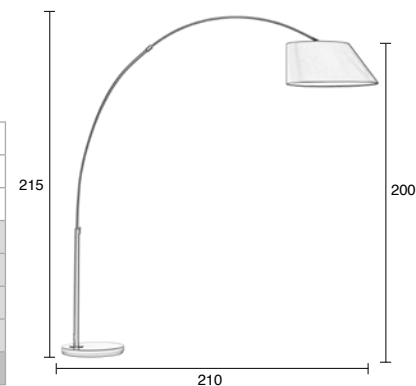



CONCRETE UP

We believe every interior deserves a good uplighter. A light fixture like that has multiple advantages. It'll cast an interesting light bundle on your walls and creates an airy feel in your room, by lighting up the usually darker ceiling. Convinced? Uplight your interior with our Concrete Up. Cast in, yes you guessed it, concrete. For an industrial, modern feel.

Concrete lampshade
Steel tube base
Black PVC cable with on/off switch
Light source: E27, max. 75 watt regular bulb
Energy efficiency class: A++ - E (Energylabel 1)

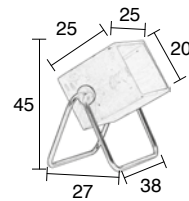

ZUIVER-CODE	GTIN-CODE	ITEM NAME		
5002901	8718548006669	FLOOR LAMP CONCRETE UP		
PACKING	1 PCS/CTN			
QTY	CTN SIZE (CM)	CBM	NW (KG)	GW (KG)
1	42,5x43x31	0,057	7,5	9,5
PRICE (1 PCS)			RETAIL € 149,00	

LED-IT-BE

Solid ashwood, natural lacquered,
dark grey iron base, red nylon wire
Cable with on/off switch
Lightsource: LED, 4200 Kelvin, not replaceable
Lifetime LED's more than 15.000 hours
Energy efficiency class: A++ - A (Energylabel 2)

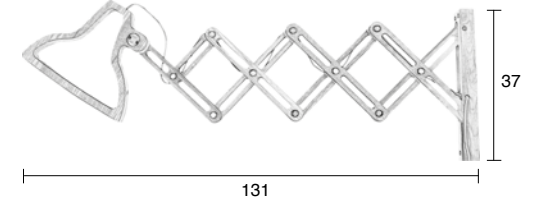

ZUIVER-CODE	GTIN-CODE	ITEM NAME		
5400000	8718548015890	WALL LAMP LED IT BE NATURAL		
PACKING	1 PCS/CTN			
QTY	CTN SIZE (CM)	CBM	NW (KG)	GW (KG)
1	67x46x13	0,04	1,6	3,1
PRICE (1 PCS)			RETAIL € 169,00	



We are pretty psyched about our LED-it-be lamp, which comes in a floor, table and wall version. It's a hyper modern LED lamp pretending to be an old fashioned lamp. We have noticed designers all over the world are playing with silhouettes and bringing their designs down to just simple outlines. "LED-it be "is our version of that trend. And boy, do we like it!

LED-IT-BE

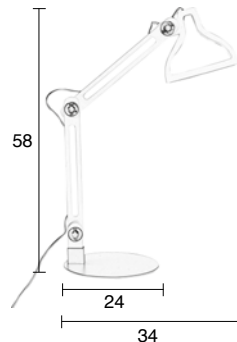

ZUIVER-CODE	GTIN-CODE	ITEM NAME		
5200004	8718548015852	TABLE LAMP LED IT BE NATURAL		
PACKING		1 PCS/CTN		
QTY	CTN SIZE (CM)	CBM	NW (KG)	GW (KG)
1	53x39x15	0,031	2,6	4
PRICE (1 PCS)			RETAIL € 139,00	
ZUIVER-CODE	GTIN-CODE	ITEM NAME		
5100014	8718548015876	FLOOR LAMP LED IT BE NATURAL		
PACKING		1 PCS/CTN		
QTY	CTN SIZE (CM)	CBM	NW (KG)	GW (KG)
1	84,5x45x17	0,065	6,5	8,8
PRICE (1 PCS)			RETAIL € 249,00	



LIGHTING



TRIPOD COPPER

Who invented the tripod base for the shaded lamp? Give the man a medal. We love it! But you probably noticed that, because we have designed a series of very elegant tripod floor lamps. And with this newest addition, Tripod Copper, we think we have earned a medal too. We combined the tripod with trendy copper. How brilliant is that? Combine Tripod Copper with a black or a white shade and just let it shine...

Knockdown textile shade with velcro
 Copper plated tripod metal base
 183 cm PVC cable with foot on/off switch
 Light source: E27, max. 25 watt savings
 Energy efficiency class: A++ - E (Energylabel 1)

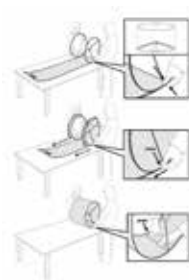

ZUIVER-CODE	GTIN-CODE	ITEM NAME		
5100053	8718548027602	FLOOR LAMP TRIPOD COPPER BLACK		
5100054	8718548027633	FLOOR LAMP TRIPOD COPPER WHITE		
PACKING	1 PCS/CTN			
QTY	CTN SIZE (CM)	CBM	NW (KG)	GW (KG)
1	129,5x53,5x15	0,104	4	7
PRICE (1 PCS)			RETAIL € 219,00	



TRIPOD CORK

We've worked it out: we've had paper shades, veneer shades, wooden shades, brass and other kinds of metal shades... Now we are happy to announce we chose a cork shade for this Tripod floorlamp. Cork is a real treat, made for us by Mother Nature. It has pleasant warm colour variations and is durable.

Knockdown cork shade with velcro
 Colour coated tripod metal base
 PVC cable with foot on/off switch
 Light source: E27, max. 25 watt savings
 Energy efficiency class: A++ - E (Energylabel 1)



ZUIVER-CODE	GTIN-CODE	ITEM NAME		
5100049	8718548025943	FLOOR LAMP TRIPOD CORK WHITE		
5100050	8718548025950	FLOOR LAMP TRIPOD CORK BLACK		
PACKING	1 PCS/CTN			
QTY	CTN SIZE (CM)	CBM	NW (KG)	GW (KG)
1	129,5x53,5x15	0,104	3,8	7
PRICE (1 PCS)			RETAIL € 219,00	



LIGHTING



TRIPOD WOOD

Elegant and loooooong thin legs. But, make no mistake: Tripod Wood is far from fragile. This three legged beauty is a 21st century answer to the good old shaded-lamp. Just pick your colour and light up that dark corner in the room.

Knockdown textile shade with velcro
 Wood veneered tripod metal base
 PVC cable with foot on/off switch
 Light source: E27, max. 25 watt savings
 Energy efficiency class: A++ - E (Energylabel 1)



ZUIVER-CODE	GTIN-CODE	ITEM NAME		
5000805	8718548005846	FLOOR LAMP TRIPOD WOOD BLACK		
5000806	8718548005853	FLOOR LAMP TRIPOD WOOD WHITE		
PACKING	1 PCS/CTN			
QTY	CTN SIZE (CM)	CBM	NW (KG)	GW (KG)
1	129,5x53,5x15	0,104	3,9	7,1
PRICE (1 PCS)			RETAIL € 199,00	





TRIPOD WOOD

Knockdown textile shade with velcro
 Wood veneered tripod metal base
 160 cm PVC cable with on/off switch,
 attached to socket of the lamp
 Light source: E27, max. 13 watt savings
 Energy efficiency class: A++ - E (Energylabel 1)



ZUIVER-CODE	GTIN-CODE	ITEM NAME		
5200008	8718548017757	TABLE LAMP TRIPOD WOOD BLACK		
5200009	8718548017764	TABLE LAMP TRIPOD WOOD WHITE		
PACKING	4 PCS/CTN	ORDER QTY: 4 PCS		
QTY	CTN SIZE (CM)	CBM	NW (KG)	GW (KG)
1	32x32x18,5	0,02	0,96	1,68
4	66x34x40	0,09	3,6	7,9
PRICE (1 PCS)			RETAIL € 99,00	

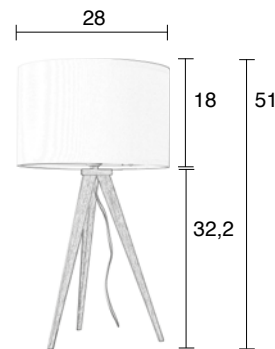



TRIPOD

Elegant and loooooong, thin legs. But, make no mistake: Tripod is far from fragile. This three legged beauty is the 21st century answer to the good old shaded-lamp. Just pick a colour for your base and shade and light up that dark corner in the room.

Knockdown textile shade with velcro
 Tripod metal base, lacquered
 PVC cable with foot on/off switch
 Light source: E27, max. 25 watt savings
 Energy efficiency class: A++ - E (Energylabel 1)

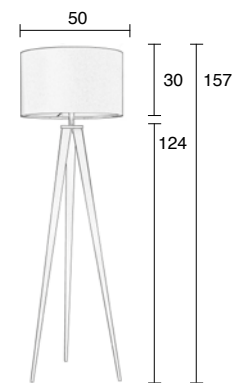

ZUIVER-CODE	GTIN-CODE	ITEM NAME		
5000800	8718548005792	FLOOR LAMP TRIPOD BLACK/GREY		
5000801	8718548005808	FLOOR LAMP TRIPOD BLACK		
5000802	8718548005815	FLOOR LAMP TRIPOD WHITE		
PACKING	1 PCS/CTN			
QTY	CTN SIZE (CM)	CBM	NW (KG)	GW (KG)
1	129,5x53,5x15	0,104	3,8	6,77
PRICE (1 PCS)			RETAIL € 169,00	



TRIPOD

A table lamp with legs so long, you can see them from a mile away. Well ok, that's just a matter of speech. But the fact of the matter is, those legs are exactly high enough to light your table from just the right height. Yep, we've put effort in figuring that out... Needless to say she comes in lots of different versions. Wooden legs? Black? White shade or black? It is up to you.

Knockdown textile shade with velcro
 Tripod metal base, lacquered
 160 cm PVC cable with on/off switch,
 attached to socket of the lamp
 Light source: E27, max. 13 watt savings
 Energy efficiency class: A++ - E (Energylabel 1)

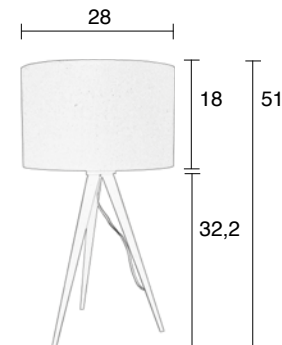

ZUIVER-CODE	GTIN-CODE	ITEM NAME		
5200006	8718548017733	TABLE LAMP TRIPOD BLACK		
5200007	8718548017740	TABLE LAMP TRIPOD WHITE		
5200010	8718548019287	TABLE LAMP TRIPOD BLACK/GREY		
PACKING	4 PCS/CTN	ORDER QTY: 4 PCS		
QTY	CTN SIZE (CM)	CBM	NW (KG)	GW (KG)
1	32x32x18,5	0,02	0,96	1,68
4	66x34x40	0,09	3,6	7,9
PRICE (1 PCS)			RETAIL € 79,00	



HIGHLAND

Our Highland here is a Dutch design lamp. So Dutch in fact, it even has wooden shoes! Highland's metal tripod frame ends its long, slender legs in a wooden detail. It comes in dark grey and white. Simply to give you a choice.

Knockdown textile shade with velcro
 Tripod metal base, lacquered
 Rubberwood legs
 PVC cable with on/off switch
 Light source: E27, max. 18 watt savings
 Energy efficiency class: A++ - E (Energylabel 1)



ZUIVER-CODE	GTIN-CODE	ITEM NAME		
5100036	8718548019577	FLOOR LAMP HIGHLAND WHITE		
5100037	8718548019584	FLOOR LAMP HIGHLAND DARK GREY		
PACKING	1 PCS/CTN			
QTY	CTN SIZE (CM)	CBM	NW (KG)	GW (KG)
1	96x53,5x15	0,077	4,2	7,1
PRICE (1 PCS)			RETAIL € 179,00	



HIGHLAND

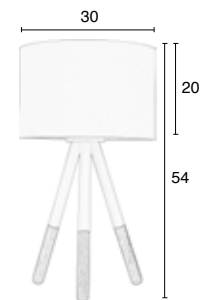
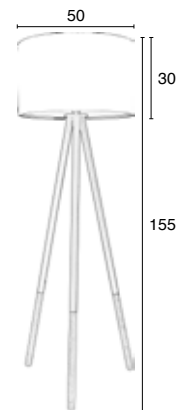

ZUIVER-CODE	GTIN-CODE	ITEM NAME		
5200015	8718548019546	DESK LAMP HIGHLAND WHITE		
5200016	8718548019553	DESK LAMP HIGHLAND DARK GREY		
PACKING	4 PCS/CTN	ORDER QTY: 4 PCS		
QTY	CTN SIZE (CM)	CBM	NW (KG)	GW (KG)
1	33x33x20	0,0218	1,32	2
4	35x68x43	0,102	5,3	9,2
PRICE (1 PCS)			RETAIL € 89,00	



LIGHTING



STUDY

Can one feel the urge to become friends with a lamp? We thought not, until we made Study, right here. Just look at the little fella! Who can resist a quick touch, a little pet on it's cute little head? All grown up though, standing on his sturdy wooden stand.

Study comes as a floor- and desk lamp and in two colours.

Powdercoated metal shade & base
Natural oak body, adjustable in height
Tilttable shade

Textured cable with on/off switch

Light source: E27, max. 13 watt savings

Energy efficiency class: A++ - E (Energylabel 1)

ZUIVER-CODE	GTIN-CODE	ITEM NAME		
5100033	8718548019515	FLOOR LAMP STUDY WHITE		
5100034	8718548019522	FLOOR LAMP STUDY DARK GREY		
PACKING		1 PCS/CTN		
QTY	CTN SIZE (CM)	CBM	NW (KG)	GW (KG)
1	130x35x19	0,086	5,28	7,38
PRICE (1 PCS)			RETAIL € 159,00	
ZUIVER-CODE	GTIN-CODE	ITEM NAME		
5200012	8718548019485	DESK LAMP STUDY WHITE		
5200013	8718548019492	DESK LAMP STUDY DARK GREY		
PACKING		1 PCS/CTN, 4 PCS/MASTERCTN		
QTY	CTN SIZE (CM)	CBM	NW (KG)	GW (KG)
1	25x25x43	0,027	2,7	3,6
PRICE (1 PCS)			RETAIL € 99,00	

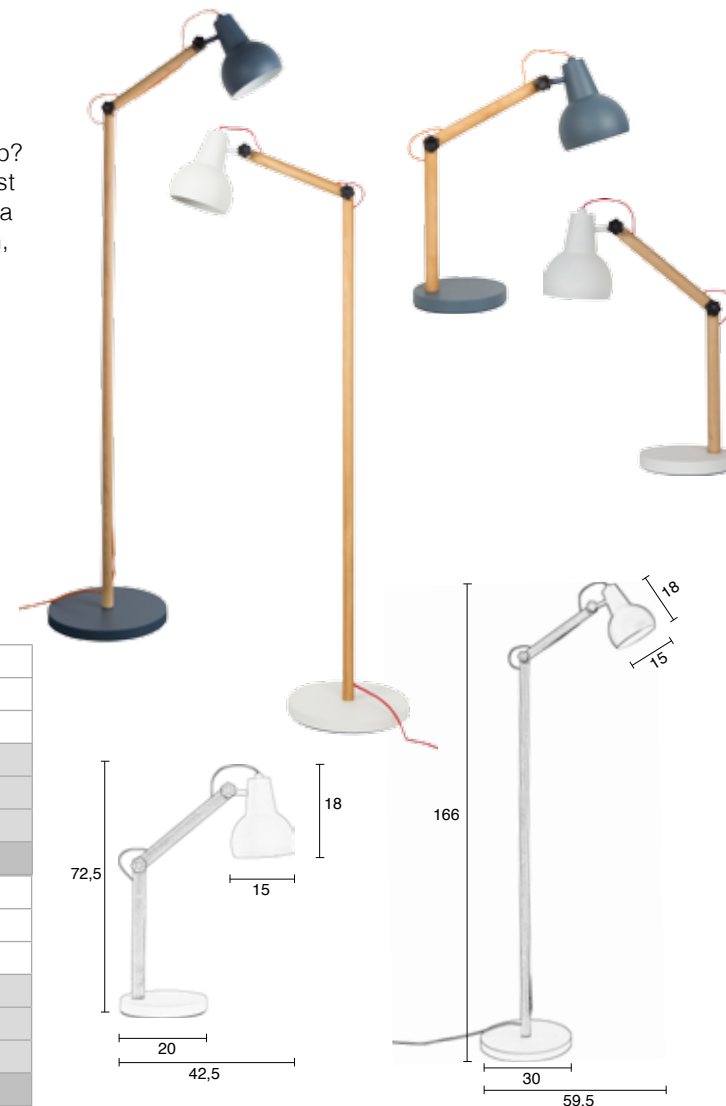



WOOD

The perfect table lamp for a luxurious home. Place your Wood, somewhat regardless, on a cabinet and stand back. Now you can see how its wooden base, partly covered in glossy lacquer, and big shade will push-up your interior.

Textile shade

Laminated wooden base, with glossy lacquer finish on back and front
PVC cable with on/off switch, attached to socket of the lamp

Light source: E27, max. 25 watt savings

Energy efficiency class: A++ - E (Energylabel 1)

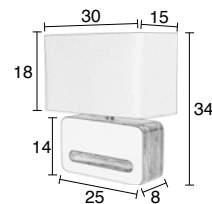

ZUIVER-CODE	GTIN-CODE	ITEM NAME		
5000803	8718548005822	TABLE LAMP WOOD WHITE		
5000804	8718548005839	TABLE LAMP WOOD BLACK		
PACKING	1 PCS/CTN			
QTY	CTN SIZE (CM)	CBM	NW (KG)	GW (KG)
1	34,5x20x30	0,021	2,08	2,6
PRICE (1 PCS)			RETAIL € 89,00	





READER

Reader makes all of us a little greedy. Who doesn't want a light fixture like this? And it doesn't help that it comes in two sizes. And to make matters even worse: we keep updating this baby, so it's always in sync with the latest trends. Reader doesn't only come in all time favorite yellow, white and black, but now also available in hip copper! Who can resist this floor and desk lamp with its serene look and feel?

Metal structure, copper plated or coated in matte black, white or yellow

Adjustable in height

Tiltable shade

Textured cable with on/off switch

Wire length: 157 (desk), 188 (floor)

Dimensions shade: 17x18,6 cm (Ø x H)

Dimensions base (desk): 22x2,3 cm (Ø x H)

Dimensions base (floor): 25x2,5 cm (Ø x H)

Light source: E27, max. 22 watt savings

Energy efficiency class: A++ - E (Energylabel 1)

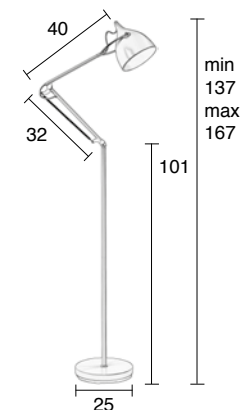

ZUIVER-CODE	GTIN-CODE	ITEM NAME		
5000951	8718548005976	FLOOR LAMP READER MATT BLACK		
5100001	8718548006850	FLOOR LAMP READER MATT WHITE		
5100002	8718548006867	FLOOR LAMP READER MATT YELLOW		
5100042	8718548022195	FLOOR LAMP READER COPPER		
PACKING	1 PCS/CTN			
QTY	CTN SIZE (CM)	CBM	NW (KG)	GW (KG)
1	43x21x54	0,049	5,45	6,8
PRICE COLOUR COATED (1 PCS)			RETAIL € 109,00	
PRICE COPPER (1 PCS)			RETAIL € 129,00	



READER



ZUIVER-CODE	GTIN-CODE	ITEM NAME		
5000950	8718548005969	DESK LAMP READER MATT BLACK		
5200001	8718548006911	DESK LAMP READER MATT WHITE		
5200002	8718548006928	DESK LAMP READER MATT YELLOW		
5200019	8718548022201	DESK LAMP READER COPPER		
PACKING	1 PCS/CTN			
QTY	CTN SIZE (CM)	CBM	NW (KG)	GW (KG)
1	43x21x54	0,049	3,09	4,8
PRICE COLOUR COATED (1 PCS)			RETAIL € 89,00	
PRICE COPPER (1 PCS)			RETAIL € 99,00	

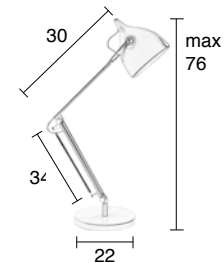

Desk lamp Broker has an impersonator. It's true!
 Desk lamp Broker Concrete impersonates desk lamp Broker Black. Or the other way around. We're not sure to be honest. All we know is, that both have the right to exist. See, the concrete version has a shade made from actual concrete. And it is the un-sanded powder coated finish and chic copper coloured inside of the shade that makes Broker Black stand out.
 So it's up to you to pick a favourite. We couldn't.....



BROKER

Textured powder coated iron structure
 Tilttable shade in:

- black powder coated iron, copper coloured inside
- all concrete

Textured cable with on/off switch

Wired length: 160 cm

Dimensions shade: 26x15x7,5 cm (WxDxH)

Dimensions base: 30x20,5x35 cm (WxDxH)

Light source: E27, max. 25 watt regular bulb, max. 18 watt savings, max. 5 watt LED

Energy efficiency class: A++ - E (Energylabel 1)

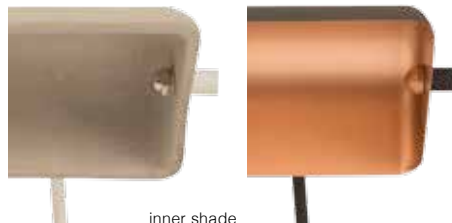

inner shade



ZUIVER-CODE	GTIN-CODE	ITEM NAME		
5200026	8718548026988	DESK LAMP BROKER BLACK		
5200027	8718548026995	DESK LAMP BROKER CONCRETE		
PACKING	1 PCS/CTN			
QTY	CTN SIZE (CM)	CBM	NW (KG)	GW (KG)
1 BLACK	32x22x42	0,03	1,7	2,62
1 CONCRETE	36x23x44	0,036	2,2	3,04
PRICE (1 PCS)			RETAIL € 89,50	

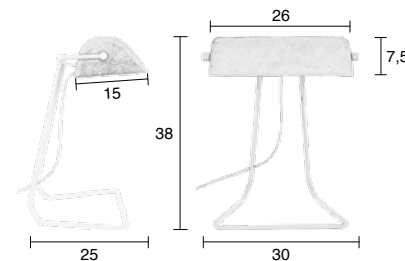



MARVEL

It is marvelling how marvellous a simple copper form can transform into a beautiful little pendant lamp. Hence the name we gave this Zuiver beauty: Marvel. We gave Marvel a specially designed copper coloured inside. As a result, it emits a very nice light creating a warm ambience.

Iron shade, brushed copper plated
 Honeycomb texture inside
 128 cm black textured cable
 Black iron canopy, 12x2 cm (Ø x H)
 Light source: E27, max. 15 watt savings,
 max. 5 watt LED. Do not use regular bulb.
 Energy efficiency class: A++ - E (Energylabel 1)



ZUIVER-CODE	GTIN-CODE	ITEM NAME		
5300084	8718548027008	PENDANT LAMP MARVEL COPPER		
PACKING	1 PCS/CTN, 8 PCS/MASTERCTN			
QTY	CTN SIZE (CM)	CBM	NW (KG)	GW (KG)
1	20x20x28	0,01	0,85	1,26
8	42x42x60	0,11	6,8	11,2
PRICE COPPER (1 PCS)			RETAIL € 69,00	

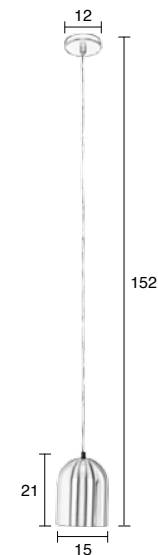



FLEX NEW

Meet your new favourite wall lamp: Flex. Isn't it a cutie? Our complete Zuiver team loves this cheeky little rascal of a lamp. And that love already started when it only existed on the drawing board! This is the sort of lamp you start to talk to, if you're not careful. You could find yourself saying: 'Hello there Lamy, let's move your little handle to the wall, shall we?' O, boy... Well, be warned: Preferably avoid talking to Flex while someone else is in earshot...

Steel shade and base in matte white or glossy grey
 Tilttable shade with handle and on/off dimmer switch on top, gold coloured inside
 Extendable arm: Solid rubber wood, natural lacquered
 160 cm black & white textured cable
 Light source: G9, 18 watt (included)
 Energy efficiency class: B - E (Energylabel 7)



ZUIVER-CODE	GTIN-CODE	ITEM NAME		
5400005	8718548030664	WALL LAMP FLEX WHITE		
5400006	8718548030671	WALL LAMP FLEX GREY		
PACKING	2 PCS/CTN	ORDER QTY: 2 PCS		
QTY	CTN SIZE (CM)	CBM	NW (KG)	GW (KG)
1	30x14x34	0,014	1,8	2,3
2	36x31,5x31,5	0,036	3,6	5,2
PRICE (1 PCS)			RETAIL € 105,00	





FLEX NEW

Of course we wanted more of Flex... Who could blame us?! Look at it! Who could resist? Table lamp Flex comes in the same colours as its brother on the wall. And of course, with the same adjustable wooden arm and dimmable light source, again, just like its brother. Who wouldn't want to buy them as a pair? We leave you with that thought...

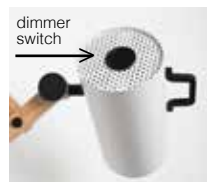

ZUIVER-CODE	GTIN-CODE	ITEM NAME		
5200029	8718548030688	TABLE LAMP FLEX WHITE		
5200030	8718548030695	TABLE LAMP FLEX GREY		
PACKING	2 PCS/CTN	ORDER QTY: 2 PCS		
QTY	CTN SIZE (CM)	CBM	NW (KG)	GW (KG)
1	36x26x51	0,048	4,6	5,9
2	54,5x38x52,5	0,109	9,2	12,8
PRICE (1 PCS)			RETAIL € 115,00	

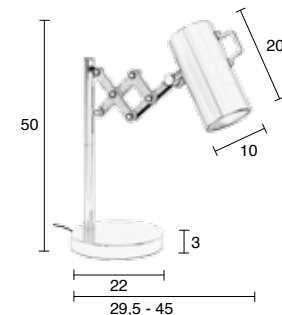

LIGHTING



SABER NEW

Don't we all know that person who always finds those perfect vintage decorating icons we ourselves never seem to find? Well, at Zuiver we turned things around. That cinema lightbox with lettering? We made it for you. No need to sand it down, rewire it or find bulb sizes which aren't produced anymore; Our Wall lamp Saber simply works from the very start and uses environmentally friendly LEDs! The only thing left to do, is finding the perfect phrase. What's yours?

Iron light box in oak pattern with frosted plexiglass
 Mixed set of black polypropylene letters & numbers included (105 pieces)
 200 cm black PVC cable
 Lightsource: LED tube T5, 12 watt, 3000 Kelvin, not replaceable. Lifetime LED's more than 25.000 hours.
 Energy efficiency class: A+ (Energylabel 2)

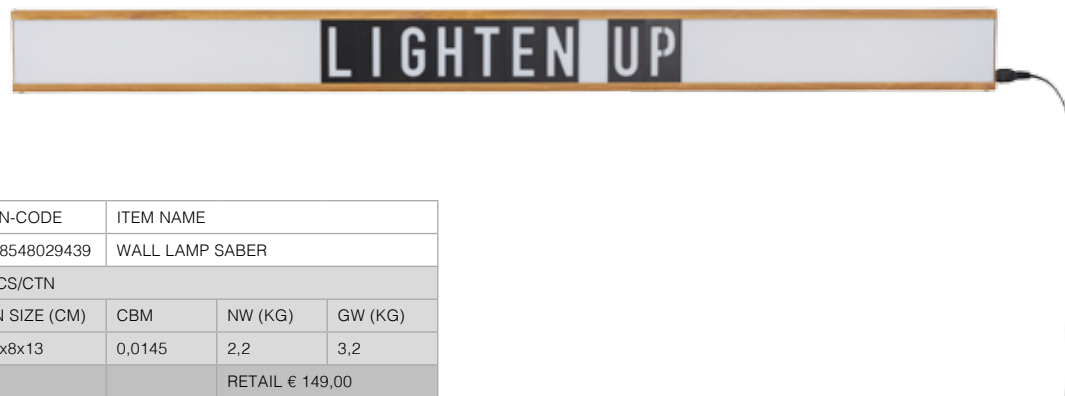
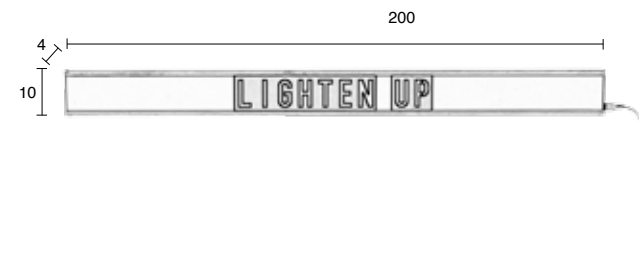

ZUIVER-CODE	GTIN-CODE	ITEM NAME		
5400004	8718548029439	WALL LAMP SABER		
PACKING	1 PCS/CTN			
QTY	CTN SIZE (CM)	CBM	NW (KG)	GW (KG)
1	139x8x13	0,0145	2,2	3,2
PRICE (1 PCS)			RETAIL € 149,00	



MESH NEW

Pendant Lamp Mesh has hidden talents. Turned off the mesh lampshade and copper lamp socket is intriguing in its simplicity, while at night, when turned on lamp Mesh projects a delicate pattern across its surroundings. It is this kind of a surprise that is worthy to a Zuiver product!

- Mesh iron shade in matte grey finish
- Copper lamp holder
- Iron canopy , grey powder coated
- 137 cm black textured cable
- Light source: E27, max. 40 watt regular bulb, max. 13 watt savings, 15 watt LED
- Energy efficiency class: A++ - E (Energylabel 1)

ZUIVER-CODE	GTIN-CODE	ITEM NAME		
5300102	8718548029637	PENDANT LAMP MESH		
PACKING	1 PCS/CTN			
QTY	CTN SIZE (CM)	CBM	NW (KG)	GW (KG)
1	39x39x54	0,082	1,55	3,75
PRICE (1 PCS)			RETAIL €119,00	





G.T.A. NEW

Isn't this pendant lamp the perfect mix between an industrial piece and a vintage pool table lamp? We gave it an extra Zuiver twist, by adding a wire mesh protection for the glass, which diffuses the light nicely. We like the industrial look of G.T.A. We love the idea of this lamp hanging above one of our tables. Where do you want to hang this industrial beauty?

Matte black powder coated or satin nickel plated iron shade with tempered glass visor and metal grid, with PET foil inbetween (removable for brighter light)
 Black powder coated iron canopy and chains
 200 cm black PVC cable
 Light source (included and replaceable): LED tube T5, 9 watt (L) 750-850 lumen or 18 watt (XL), 1550-1750 lumen, 2700-3200 Kelvin
 Not dimmable
 Energy efficiency: A++ (Energylabel 2)

ZUIVER-CODE	GTIN-CODE	ITEM NAME		
5300090	8718548029392	PENDANT LAMP G.T.A. L BLACK		
5300091	8718548029408	PENDANT LAMP G.T.A. L NICKEL		
PACKING	1 PCS/CTN			
QTY	CTN SIZE (CM)	CBM	NW (KG)	GW (KG)
1	78,5x19x22	0,033	3,7	4,85
PRICE (1 PCS)			RETAIL € 199,00	

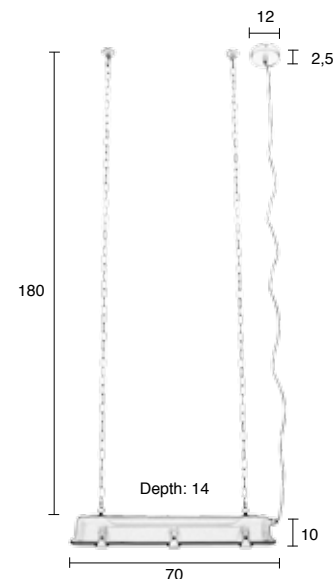



G.T.A. NEW

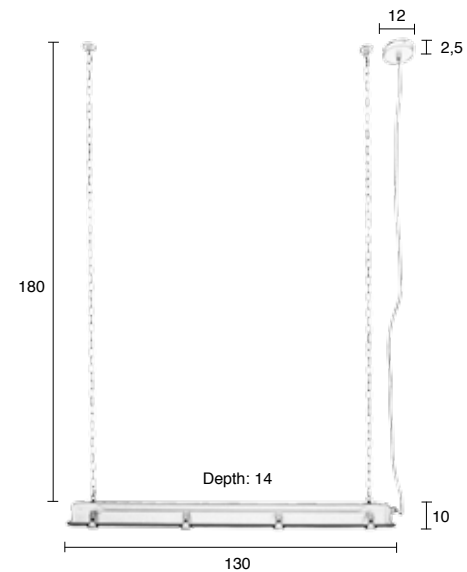

ZUIVER-CODE	GTIN-CODE	ITEM NAME		
5300092	8718548029415	PENDANT LAMP G.T.A. XL BLACK		
5300093	8718548029422	PENDANT LAMP G.T.A. XL NICKEL		
PACKING	1 PCS/CTN			
QTY	CTN SIZE (CM)	CBM	NW (KG)	GW (KG)
1	139x19x22	0,058	6,05	7,7
PRICE (1 PCS)			RETAIL € 249,00	



LIGHTING



LEFT



Illumination on an industrial level. That's concrete pendant lamp Left. It is designed by Zuiver to find its home in urban, industrial settings. But does just as well in more rustic surroundings. Left is small enough to be used in clusters or as a pair, but big enough to leave an impression! Left comes in a raw concrete colour and in black. Both are blessed with a nice textile cable.

Concrete shade in natural or black
 Black powder coated iron canopy
 130 cm black textured PVC cable
 Light source: E27, max. 40 watt regular bulb
 max. 13 watt savings, max. 6 watt LED
 Energy efficiency class: A++ - E (Energylabel 1)

ZUIVER-CODE	GTIN-CODE	ITEM NAME		
5300094	8718548029446	PENDANT LAMP LEFT CONCRETE		
5300095	8718548029453	PENDANT LAMP LEFT BLACK		
PACKING	6 PCS/CTN	ORDER QTY: 6 PCS		
QTY	CTN SIZE (CM)	CBM	NW (KG)	GW (KG)
1	16X16X22,5	0,006	1,1	1,3
6	51X35X24,5	0,044	6,6	8,3
PRICE (1 PCS)		RETAIL € 59,00		





PULP SHADES NEW

Pendant Lamp Pulp Shades is like a bouquet of flowers. Hoisted together in a fun bunch. And these pretty shades? You'll never guess what they are made from: papier-mâché from recycled paper! We added an extra long textile cable to this bunch so you can artfully tie it together or roll it in a decorative loop with the velcro we provided. O, how we like to surprise you by adding those little extra's!

7 paper pulp shades, black outside, natural inside
 Black powder coated iron canopy
 200 cm black textured PVC cable with Zuiver velcro for adjusting the cable length
 Light source: 7x E14, max. 15 watt regular bulb, max. 3 watt savings, max. 1 watt LED
 Energy efficiency class: A++ - E (Energylabel 1)

ZUIVER-CODE	GTIN-CODE	ITEM NAME		
5300096	8718548029460	PENDANT LAMP PULP SHADES BLACK		
PACKING	1 PCS/CTN			
QTY	CTN SIZE (CM)	CBM	NW (KG)	GW (KG)
1	31x31x16	0,015	1,5	2
PRICE (1 PCS)			RETAIL € 169,00	

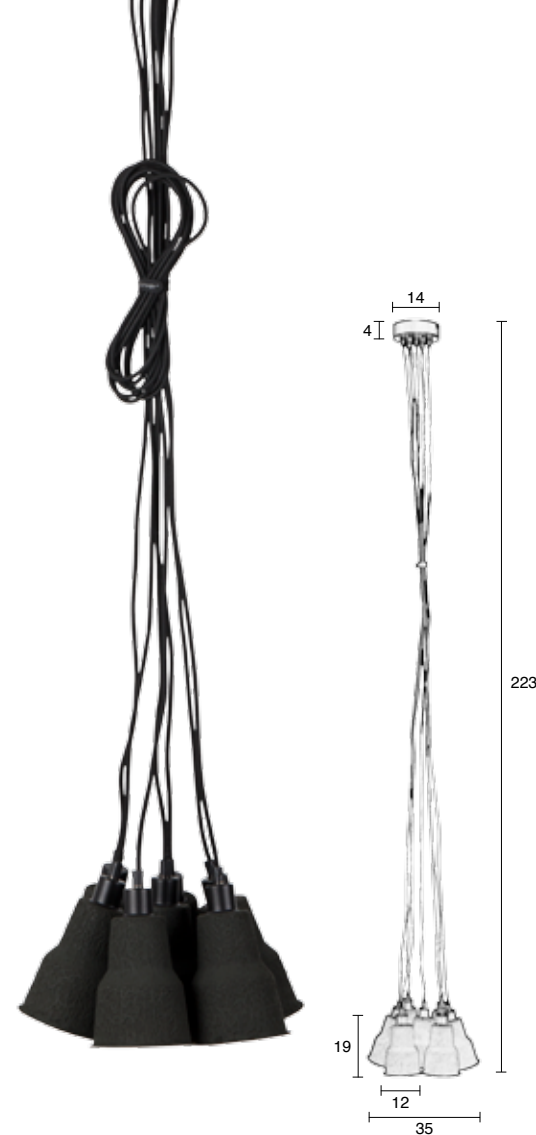



RETRO '70

If there would be a James Bond light fixture, we like to believe this is the one. Okay, our Retro '70 will not shoot bullets with a push of the button (Q wasn't involved in this design) No, Retro '70 would just casually hang in Bonds' stylish apartment. What do you think, in gold, copper or chrome?

Copper or brass plated metal shade
 Copper or brass plated canopy (12x3 cm)
 Black textured cable, adjustable in height
 Light source: E27, max. 60 watt regular bulb,
 max. 13 watt savings
 Energy efficiency class: A++ - E (Energylabel 1)



ZUIVER-CODE	GTIN-CODE	ITEM NAME		
5002442	8718548006515	PENDANT LAMP RETRO '70 COPPER r40		
5002443	8718548006522	PENDANT LAMP RETRO '70 GOLD r40		
PACKING	1 PCS/CTN			
QTY	CTN SIZE (CM)	CBM	NW (KG)	GW (KG)
1	43x43x43,5	0,080	3	4
PRICE (1 PCS)			RETAIL € 199,00	
ZUIVER-CODE	GTIN-CODE	ITEM NAME		
5300026	8718548012899	PENDANT LAMP RETRO '70 COPPER r50		
PACKING	1 PCS/CTN			
QTY	CTN SIZE (CM)	CBM	NW (KG)	GW (KG)
1	53x53x54,5	0,153	4,8	6,3
PRICE (1 PCS)			RETAIL € 329,00	

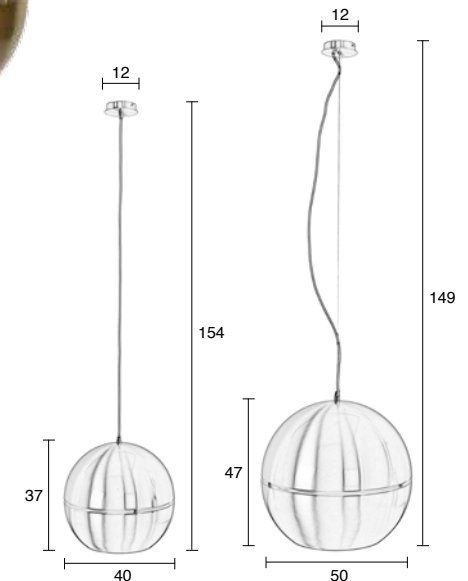



RETRO '70

Chromed metal shade
 Chromed canopy (12x3 cm)
 Grey textured cable, adjustable in height
 Light source: E27, max. 60 watt regular bulb,
 max. 13 watt savings
 Energy efficiency class: A++ - E (Energylabel 1)



ZUIVER-CODE	GTIN-CODE	ITEM NAME		
5002440	8718548006492	PENDANT LAMP RETRO '70 CHROME r40		
PACKING		1 PCS/CTN		
QTY	CTN SIZE (CM)	CBM	NW (KG)	GW (KG)
1	43x43x43,5	0,080	3	4
PRICE (1 PCS)			RETAIL € 169,00	
ZUIVER-CODE	GTIN-CODE	ITEM NAME		
5002441	8718548006508	PENDANT LAMP RETRO '70 CHROME r50		
PACKING		1 PCS/CTN		
QTY	CTN SIZE (CM)	CBM	NW (KG)	GW (KG)
1	53x53x54,5	0,153	4,8	6,3
PRICE (1 PCS)			RETAIL € 239,00	

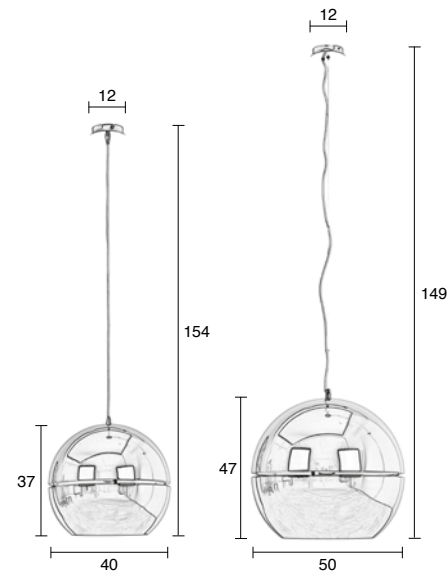

LIGHTING



BIG GLOW

This small retro-look pendant lamp will never fail to give your interior that seventies feel, we all like so much nowadays. Pick your favorite, because Big Glow comes in more than one version.

Chromed or brushed copper/brass plated metal shade

Metal canopy, 8,4x5,5 cm (Ø x H)

Black textured cable, 100 cm

Light source: E27, max. 60 watt regular bulb, max. 20 watt savings, max. 8 watt LED

Energy efficiency class: A++ - E (Energylabel 1)



ZUIVER-CODE	GTIN-CODE	ITEM NAME		
5002006	8718548006157	PENDANT LAMP BIG GLOW CHROME		
5300034	8718548015074	PENDANT LAMP BIG GLOW COPPER		
5300081	8718548025868	PENDANT LAMP BIG GLOW BRASS		
PACKING	1 PCS/CTN			
QTY	CTN SIZE (CM)	CBM	NW (KG)	GW (KG)
1	32,5x32x26,5	0,028	1,3	1,8
PRICE CHROMED (1 PCS)			RETAIL € 69,00	
PRICE COPPER/BRASS (1 PCS)			RETAIL € 89,00	



PLENTY WORK

Plentywork always seems to be in motion. Which it is not, of course. It's the two lengths of pins that make it seem so different from every angle. And if you think Plentywork looks stunning now, wait until it gets dark and see what Plentyworks shadow does to your walls... Wow!

Metal sphere with pins in two lengths and discs in white, brass or copper
 Transparent cable, steel wire
 Light source: 6 sockets, E14, max. 40 watt regular bulb, max. 13 watt savings, max. 5 watt LED
 Energy efficiency class: A++ - E (Energylabel 1)

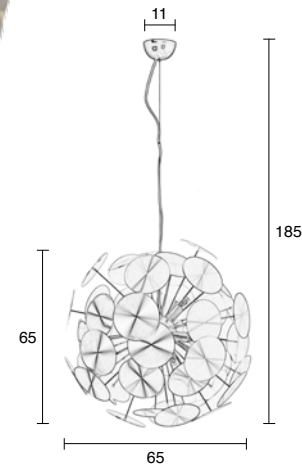
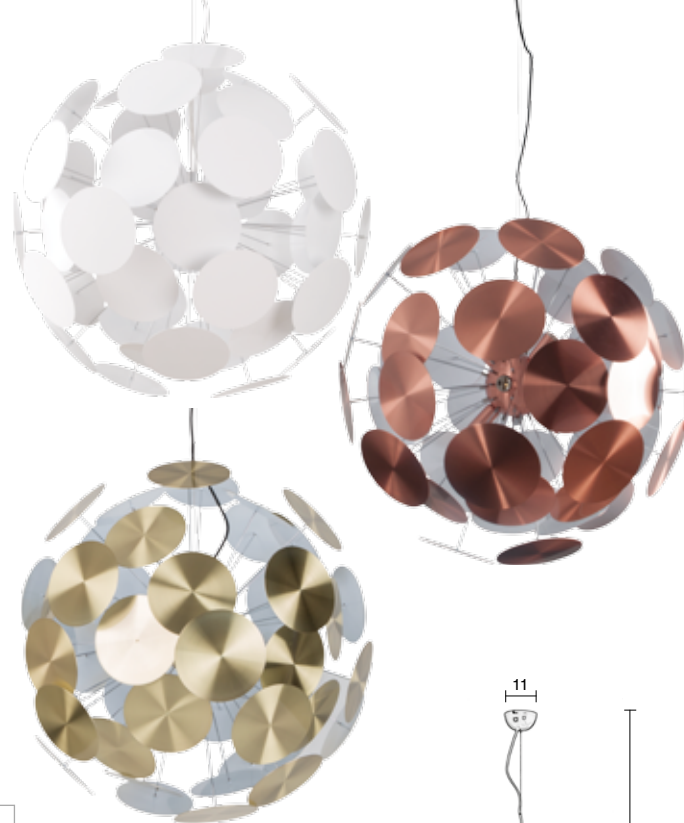

ZUIVER-CODE	GTIN-CODE	ITEM NAME		
5002024	8718548006256	PENDANT LAMP PLENTY WORK WHITE		
5300040	8718548018945	PENDANT LAMP PLENTY WORK COPPER		
5300082	8718548025875	PENDANT LAMP PLENTY WORK BRASS		
PACKING	1 PCS/CTN			
QTY	CTN SIZE (CM)	CBM	NW (KG)	GW (KG)
1	39x38,5x22	0,033	7,2	8,8
PRICE WHITE (1 PCS)			RETAIL € 229,00	
PRICE COPPER (1 PCS)			RETAIL € 269,00	
PRICE BRASS (1 PCS)			RETAIL € 305,00	



LIGHTING



MORA S

The S in Mora S's name doesn't stand for 'Small', but for 'Style'. Just so you know. Although, we will admit she is our smallest pendant lamp. But still, don't let that fool you. She might be modest in size, but she is packed with style!

Metal shade, in black, white, copper or gold plated
 Black or white textured cable
 Metal canopy, 10x5,5 cm (Ø x H)
 Light source: E27, max. 18 watt savings
 Energy efficiency class: A++ - E (Energylabel 1)



ZUIVER-CODE	GTIN-CODE	ITEM NAME		
5000930	8718548005938	PENDANT LAMP MORA S WHITE		
5000931	8718548005945	PENDANT LAMP MORA S BLACK		
5000932	8718548005952	PENDANT LAMP MORA S COPPER		
5300085	8718548026513	PENDANT LAMP MORA S BRASS		
PACKING	1 PCS/CTN, 8 PCS/MASTERCTN			
QTY	CTN SIZE (CM)	CBM	NW (KG)	GW (KG)
1	11x11x27,5	0,003	0,45	0,56
8	23x23x58	0,031	3,9	4,95
PRICE WHITE/BLACK (1 PCS)			RETAIL € 39,00	
PRICE COPPER/BRASS (1 PCS)			RETAIL € 49,00	

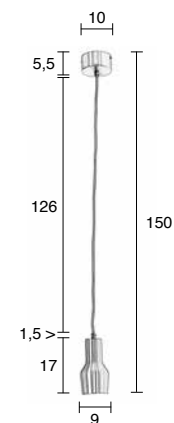



DELIVING

Who would have thought it! It turns out that the industrial trend has a soft, more feminine side to it as well. Meet Deliving. In all white for bright light, and in copper it's a real eye popper!

Metal shade and canopy (12x2,5 cm)
 Copper plated or glossy white finish outside, matt white inside
 Textured cable, adjustable in height
 Light source: E27, max. 60 watt regular bulb, max. 13 watt savings
 Energy efficiency class: A++ - E (Energylabel 1)

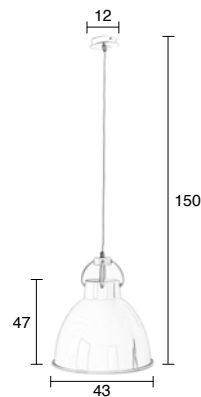

ZUIVER-CODE	GTIN-CODE	ITEM NAME		
5002450	8718548006539	PENDANT LAMP DELIVING WHITE		
5300103	8718548030510	PENDANT LAMP DELIVING COPPER		
PACKING	1 PCS/CTN			
	CTN SIZE (CM)	CBM	NW (KG)	GW (KG)
WHITE	44x44x49	0,095	1,36	2,5
COPPER	46x46x38	0,08	1,28	2,42
PRICE WHITE (1 PCS)			RETAIL € 99,00	
PRICE COPPER (1PCS)			RETAIL € 149,00	



BIRDY NEW

We hear you think 'where is the bird?!'. Well, actually we don't know! We're just as confused as you are, because what bird wouldn't want to live in a stylish bird cage like this? Okay, okay... We're just kidding. Zuiver Birdy is a pendant lamp! The elegant wooden fitting matches perfectly with the braided rattan. Zuiver Birdy comes in two sizes: long and wide. The light shines evenly through the grey wire frame and will illuminate your dining room in a very special way. You could also combine the two versions and hang them next to the sofa or in the hallway. Why not complement Birdy lamp with one of our unique and trendy LED light bulbs?

Iron wire shade in matte grey with braided rattan border
 Solid rubberwood lamp holder
 Black iron canopy (Ø 12x2,5 cm)
 110 cm black PVC cable
 Light source: E27, max. 40 watt regular bulb, max. 13 watt savings, 5 watt LED
 Energy efficiency class: A++ - E (Energylabel 1)

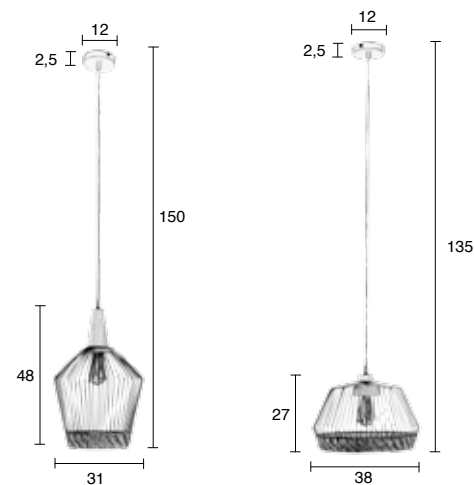

ZUIVER-CODE	GTIN-CODE	ITEM NAME		
5300105	8718548031548	PENDANT LAMP BIRDY LONG		
5300106	8718548031555	PENDANT LAMP BIRDY WIDE		
PACKING	1 PCS/CTN, 6 PCS/MASTERCARTON			
QTY	CTN SIZE (CM)	CBM	NW (KG)	GW (KG)
1 (LONG)	32x32x36,5	0,037	1,16	1,54
1 (WIDE)	38,5x38,5x26,5	0,039	1,29	1,65
6 (LONG)	99,5x34,5x76	0,261	6,96	11,5
6 (WIDE)	82,5x40,5x80	0,267	7,74	12
PRICE (1 PCS)				RETAIL € 69,50



Like they came straight from a well conserved, old warehouse. Vic Industry is the Zuiver answer to the huge warehouse pendant lamp trend. We bring our Vic to you in several options. Ranging from brushed metal to different colours and a matte or glossy finish. The choice is yours.

VIC INDUSTRY

Lacquered or brushed metal shade, upper part & ceiling hook
 Clear transparent visor
 Metal chain, black PVC cable
 Light source: E27, max. 40 watt regular bulb,
 max. 23 watt savings
 Energy efficiency class: A++ - E (Energylabel 1)



ZUIVER-CODE	GTIN-CODE	ITEM NAME		
5500603	8718548006997	PENDANT LAMP VIC INDUSTRY RED		
5500604	8718548007000	PENDANT LAMP VIC INDUSTRY GREY		
5500605	8718548007017	PENDANT LAMP VIC INDUSTRY BLACK MATTE		
5500606	8718548007024	PENDANT LAMP VIC INDUSTRY WHITE MATTE		
PACKING	1 PCS/CTN			
QTY	CTN SIZE (CM)	CBM	NW (KG)	GW (KG)
1	54x54x67	0,195	6,3	7,3
PRICE (1 PCS)		RETAIL € 269,00		



ZUIVER-CODE	GTIN-CODE	ITEM NAME		
5500601	8718548006980	PENDANT LAMP VIC INDUSTRY CHROME		
PACKING	1 PCS/CTN			
QTY	CTN SIZE (CM)	CBM	NW (KG)	GW (KG)
1	54x54x67	0,195	6,3	7,3
PRICE (1 PCS)		RETAIL € 239,00		



DEK 40

Sometimes a product is so fabulous it doesn't need much of an introduction. Take Pendant Lamp Dek for instance. Look at the fabulous combo of thick leather, brushed metal and the trendy barn lamp shade. What can we say? Dek has it all: Style, function and good looks. Dek is a genuine Dutch design and comes in three colours and two different models.

Metal shade and canopy (12x2,5 cm)
 Leather strap & black PVC cable
 Light source: E27, max. 60 watt regular bulb,
 max. 23 watt savings
 Energy efficiency class: A++ - E (Energylabel 1)

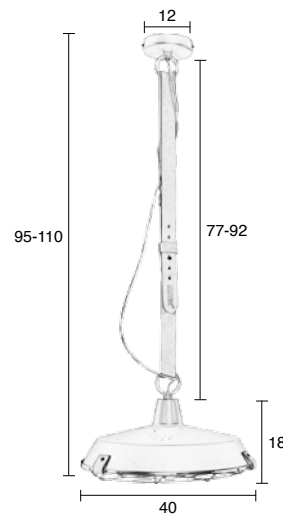

ZUIVER-CODE	GTIN-CODE	ITEM NAME		
5300062	8718548024212	PENDANT LAMP DEK 40 WHITE		
5300063	8718548024229	PENDANT LAMP DEK 40 GREY		
5300064	8718548024236	PENDANT LAMP DEK 40 ANTHRACITE		
PACKING	1 PCS/CTN			
QTY	CTN SIZE (CM)	CBM	NW (KG)	GW (KG)
1	44x44x34	0,065	2	3,4
PRICE (1 PCS)			RETAIL € 189,00	



DEK 51

Metal shade and canopy (12x2,5 cm)
 Leather strap & black PVC cable
 Light source: E27, max. 60 watt regular bulb,
 max. 23 watt savings
 Energy efficiency class: A++ - E (Energylabel 1)



Designers Viktor and Kim in their workshop, working on the special Zuiver edition of the Dek pendant lamp

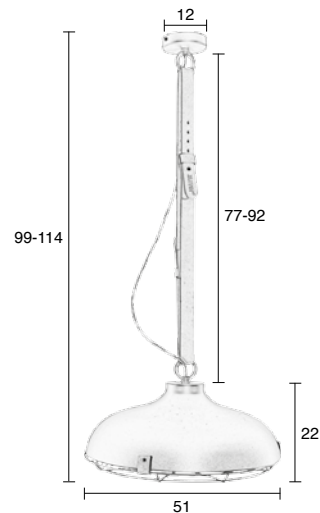

ZUIVER-CODE	GTIN-CODE	ITEM NAME		
5300065	8718548024243	PENDANT LAMP DEK 51 WHITE		
5300066	8718548024250	PENDANT LAMP DEK 51 GREY		
5300067	8718548024267	PENDANT LAMP DEK 51 ANTHRACITE		
PACKING	1 PCS/CTN			
QTY	CTN SIZE (CM)	CBM	NW (KG)	GW (KG)
1	54x54x36	0,105	3,2	4,6
PRICE (1 PCS)			RETAIL € 229,00	





CABLE

Would you rather like your pendant to be round? Please DO try this at home and enjoy the different pattern this Cable will cast on your walls! It's like instant wallpaper with the flip of the light switch. The funny thing is, the paper is not on the wall but in the lamp, since Cable is made out of wire and twisted paper.

Shade made of iron wire and twisted paper
 Chromed canopy and shade holder
 130 cm white textured cable
 Light source: E27, max. 75 watt regular bulb
 Energy efficiency class: A++ - E (Energylabel 1)

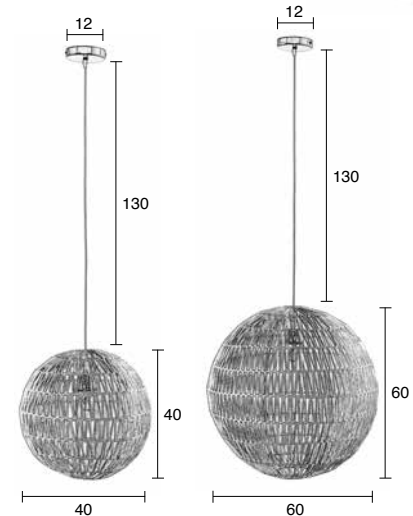

ZUIVER-CODE	GTIN-CODE	ITEM NAME		
5002805	8718548006645	PENDANT LAMP CABLE 40 WHITE		
PACKING		1 PCS/CTN		
QTY	CTN SIZE (CM)	CBM	NW (KG)	GW (KG)
1	43x43x43	0,080	1,2	1,9
PRICE (1 PCS)			RETAIL € 119,00	
ZUIVER-CODE	GTIN-CODE	ITEM NAME		
5002806	8718548006652	PENDANT LAMP CABLE 60 WHITE		
PACKING		1 PCS/CTN		
QTY	CTN SIZE (CM)	CBM	NW (KG)	GW (KG)
1	63x63x63	0,250	1,6	3,2
PRICE (1 PCS)			RETAIL € 199,00	



CABLE DROP

Drop dead gorgeous. Is that where Cable Drop's name comes from? Nope. But it should be! This pendant will not only enchant your guests, but your walls as well! Wait until you see the patterns Cable Drop will cast on your walls! It's like instant wallpaper with the flip of the light switch. Góóóorgeous!!!

Shade made of iron wire and twisted paper
Chromed canopy, 12x2,5 cm
130 cm textured cable

Light source: E27, max. 75 watt regular bulb
Energy efficiency class: A++ - E (Energylabel 1)

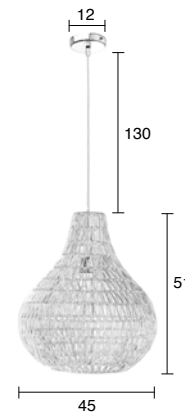

ZUIVER-CODE	GTIN-CODE	ITEM NAME		
5002803	8718548006621	PENDANT LAMP CABLE DROP WHITE		
5002804	8718548006638	PENDANT LAMP CABLE DROP BLACK		
PACKING	1 PCS/CTN			
QTY	CTN SIZE (CM)	CBM	NW (KG)	GW (KG)
1	47x47x55	0,121	1,5	2,6
PRICE (1 PCS)			RETAIL € 129,00	





Ok, here is a secret decorating tip for you. Go through your entire house and replace every boring ceiling lamp with one of our

Dice ceiling spotlights. The white Dice won't ask a lot of attention during the day. But at night! You'll be amazed what the light will do to your interior. What a difference this adjustable warm light bundle(s) will make. Do you want to spice things up during the day? In that case, Dice Copper or Galvanised should be your pick. Dazzling day and night! And so trendy!

DICE-LED

Dimmable ceiling or wall spotlight
 White lacquered, copper plated or galvanised
 Aluminium shade, 13,3 x 12 cm (Ø x D)
 Adjustable in all directions
 Steel base
 Dimensions base (WxDxH):
 Dice-1 12x12x3 cm
 Dice-2 28x12x2,5 cm
 Total height: 19,5 cm
 Light source: (1 or 2 x)12 watt AR111 LED (included),
 2700 Kelvin, 650 Lumen
 (1 or 2 x) Gallop transformer LCZT60Z
 Energy efficiency class: A+ - A (Energylabel 3)

Note: only certain 'trailing edge' dimmers are suitable for this lamp. We recommend and have tested the following types: Jung 1224LEDUDE & Niko 310-02800



ZUIVER-CODE	GTIN-CODE	ITEM NAME		
5500008	8718548028968	SPOT LIGHT DICE-1 LED WHITE		
5500010	8718548029002	SPOT LIGHT DICE-1 LED COPPER		
5500012	8718548029040	SPOT LIGHT DICE-1 LED GALVANISED		
PACKING	1 PCS/CTN, 12 PCS/MASTERCTN			
QTY	CTN SIZE (CM)	CBM	NW (KG)	GW (KG)
1	13,5x13,5x21,5	0,004	0,8	0,98
12	42,5x28,5x45,5	0,055	9,6	12,44
PRICE WHITE (1 PCS)		RETAIL € 159,00		
PRICE/1 GALV./COPPER (1 PCS)		RETAIL € 169,00		



ZUIVER-CODE	GTIN-CODE	ITEM NAME		
5500009	8718548028982	SPOT LIGHT DICE-2 LED WHITE		
5500011	8718548029026	SPOT LIGHT DICE-2 LED COPPER		
5500013	8718548029064	SPOT LIGHT DICE-2 LED GALVANISED		
PACKING	1 PCS/CTN, 6 PCS/MASTERCTN			
QTY	CTN SIZE (CM)	CBM	NW (KG)	GW (KG)
1	29,5x13,5x21	0,008	1,48	1,76
6	42,5x31x44,5	0,06	8,88	11,5
PRICE WHITE (1 PCS)		RETAIL € 279,00		
PRICE/1 GALV./COPPER (1 PCS)		RETAIL € 319,00		



LUCI-LED

Ok, here's a secret decorating tip for you. Go through your entire house and replace every boring, old ceiling lamp out there with one of our Luci ceiling spotlights. You'll be amazed what the light will do for your interior at night. What a difference this adjustable warm light bundle(s) will make. It's like a complete make-over!

Dimmable aluminium ceiling or wall spotlight

Aluminium, white or black powder coated

Shade: 10x6,5 cm (Ø x D)

Adjustable in all directions

Dimensions base (WxDxH):

Luci-1 11,5x11,5x3 cm

Luci-2 23x11,5x3 cm

Total height: 12,8 cm

Light source: (1 or 2 x) 5 watt GU10 LED (included), 3000 Kelvin, 320 Lumen

Energy efficiency class: A+ - A (Energylabel 3)

Note: only certain 'leading edge' dimmers are suitable for this lamp. We recommend and have tested the following type: Jung 1224LEDUDE



ZUIVER-CODE	GTIN-CODE	ITEM NAME		
5500607	8718548020344	SPOT LIGHT LUCI-1 LED ALU		
5500608	8718548020351	SPOT LIGHT LUCI-1 LED WHITE		
5500609	8718548020368	SPOT LIGHT LUCI-1 LED BLACK		
PACKING	1 PCS/CTN, 16 PCS/MASTERCTN			
QTY	CTN SIZE (CM)	CBM	NW (KG)	GW (KG)
1	12,5x12,5x14	0,002	0,78	0,86
16	52,5x27x30	0,04	12,5	14,6
PRICE (1 PCS)				RETAIL € 69,00

ZUIVER-CODE	GTIN-CODE	ITEM NAME		
5500610	8718548020375	SPOT LIGHT LUCI-2 LED ALU		
5500611	8718548020382	SPOT LIGHT LUCI-2 LED WHITE		
5500612	8718548020399	SPOT LIGHT LUCI-2 LED BLACK		
PACKING	1 PCS/CTN, 8 PCS/MASTERCTN			
QTY	CTN SIZE (CM)	CBM	NW (KG)	GW (KG)
1	24x12,5x14	0,004	1,38	1,5
8	50x27x30	0,04	11	13,5
PRICE (1 PCS)				RETAIL € 139,00



LIGHTING



BOLCH

Bolch is what you need when you want to show off our fabulous vintage-yet-high-tech bulbs. You can use Bolch all over the house. On your bedside table, your desk, on a bookshelf, on a cabinet... Heck, on every single surface in the house if you want! Just pick your style: copper, concrete or marble (black or white). And... You know you want to!

Cube in copper plated iron, concrete or marble with copper lamp holder
 180 cm black textured cable with on/off switch
 Dimensions: 8,5x8,5x8,5 cm (WxDxH)
 Light source: E27, max. 40 watt regular bulb, max. 13 watt savings, max. 4 watt LED
 Energy efficiency class: A++ - E (Energylabel 1)

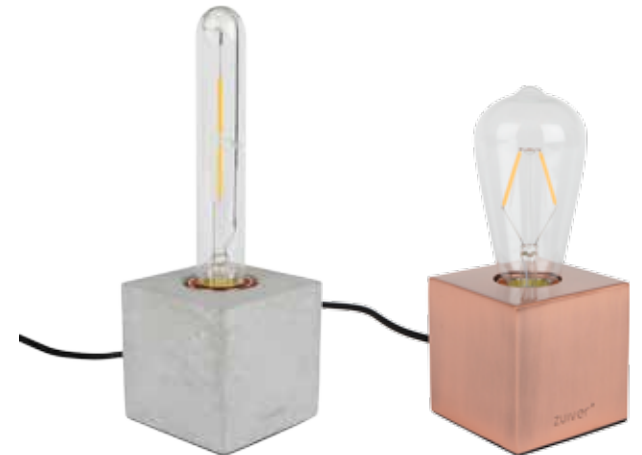
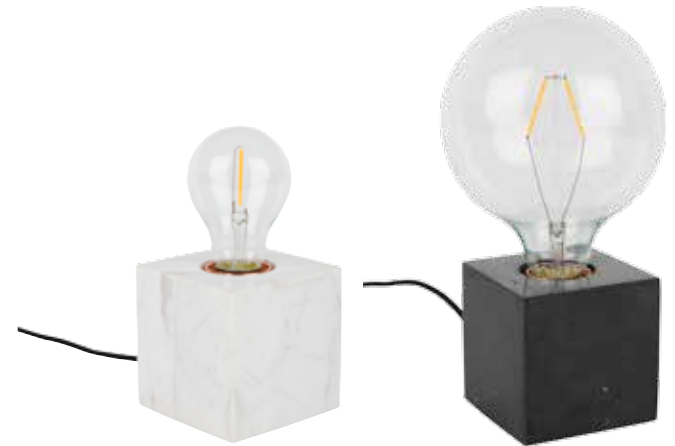

ZUIVER-CODE	GTIN-CODE	ITEM NAME		
5200021	8718548026278	TABLE LAMP BOLCH COPPER		
5200022	8718548026285	TABLE LAMP BOLCH CONCRETE		
5200023	8718548026292	TABLE LAMP BOLCH MARBLE BLACK		
5200024	8718548026308	TABLE LAMP BOLCH MARBLE WHITE		
PACKING	6 PCS/CTN	ORDER QTY: 6 PCS		
QTY	CTN SIZE (CM)	CBM	NW (KG)	GW (KG)
1 copper	11,5x11,5x14,5	0,002	0,4	0,6
6 copper	37x25,5x14,5	0,014	2,4	3,8
1 concrete	12x12x14	0,002	0,6	0,8
6 concrete	39x26x16	0,016	3,6	5,1
1 marble	15x15x20	0,004	1,6	2,3
6 marble	47,5x32,5x22	0,034	9,6	14,2
PRICE COPPER/CONCRETE (1 PCS)		RETAIL € 59,50		
PRICE MARBLE (1 PCS)		RETAIL € 89,00		



LIGHTING

ZUVER® COLLECTION 2017
NL RETAIL PRICES INCL. VAT



TRUST

Imagine a bulb fitting made entirely out of marble. Yes....we did it! Trust is the first heavy weight pendant lamp out there. And pretty! The perfect companion for our Zuiver bulbs, only the Zuiver bulbs are worthy enough to complete pendant lamp Trust.

Marble light fixture with copper lamp holder
 Black powder coated iron canopy, 10x2,5 (Ø x H)
 140 cm twisted black textile cable
 Light source: E27, max. 40 watt regular bulb,
 max. 13 watt savings, max. 4 watt LED
 Energy efficiency class: A++ - E (Energylabel 1)

ZUIVER-CODE	GTIN-CODE	ITEM NAME		
5300088	8718548026339	PENDANT LAMP TRUST MARBLE BLACK		
5300089	8718548026346	PENDANT LAMP TRUST MARBLE WHITE		
PACKING	6 PCS/CTN	ORDER QTY: 6 PCS		
QTY	CTN SIZE (CM)	CBM	NW (KG)	GW (KG)
1	16,5x16,5x23	0,006	2,17	2,5
6	52x35,5x25	0,046	13	16
PRICE (1 PCS)		RETAIL € 99,00		





MACH

Ok it is blatantly obvious. Our design light bulbs can't shine by themselves. Therefore we introduce pendant lamp Mach. It comes in copper or concrete. Both can be considered to be the icing on the cake when it comes to our LED bulb series.

Copper plated iron or concrete light fixture with copper lamp holder
 Copper plated or black powder coated iron canopy, 10x2,5 cm (Ø x H)
 140 cm twisted black textile cable
 Light source: E27, max. 40 watt regular bulb, max. 13 watt savings, max. 4 watt LED
 Energy efficiency class: A++ - E (Energylabel 1)

ZUIVER-CODE	GTIN-CODE	ITEM NAME		
5300086	8718548026315	PENDANT LAMP MACH COPPER		
5300087	8718548026322	PENDANT LAMP MACH CONCRETE		
PACKING	6 PCS/CTN	ORDER QTY: 6 PCS		
QTY	CTN SIZE (CM)	CBM	NW (KG)	GW (KG)
1 copper	13,5x13,5x13	0,002	0,29	0,55
6 copper	43x29x15	0,019	1,75	3,6
1 concrete	12x12x14	0,002	0,5	0,7
6 concrete	39x26x16	0,016	3	4,5
PRICE (1 PCS)			RETAIL € 49,00	





CLASSIC LED BULB



LED with the look of a vintage incandescent bulb!
Does it get any better?

Classic shaped clear glass bulb
E27, 1 watt LED, 73,67 lumen, 2700 Kelvin
Not suitable for dimmer
Dimensions 59x108 mm (Ø x H)
Energy efficiency class: A++ (Energylabel 4)

ZUIVER-CODE	GTIN-CODE	ITEM NAME		
5600001	8718548026216	BULB CLASSIC LED		
PACKING	12 PCS/CTN	ORDER QTY: 12 PCS		
QTY	CTN SIZE (CM)	CBM	NW (KG)	GW (KG)
1	6,3x6,3x13	0,0005	0,032	0,057
12	27x20,5x15	0,0083	0,384	0,9
PRICE (1 PCS)		RETAIL € 9,50		

DROP LED BULB



Like the ones your grandparents used to use, only
ultra modern now!

Drop shaped clear glass bulb
E27, 2 watt LED, 144 lumen, 2700 Kelvin
Not suitable for dimmer
Dimensions 64x142 mm (Ø x H)
Energy efficiency class: A+ (Energylabel 5)

ZUIVER-CODE	GTIN-CODE	ITEM NAME		
5600002	8718548026223	BULB DROP LED		
PACKING	12 PCS/CTN	ORDER QTY: 12 PCS		
QTY	CTN SIZE (CM)	CBM	NW (KG)	GW (KG)
1	6,8x6,8x14,5	0,0007	0,05	0,07
12	29,2x22x16,5	0,0106	0,6	1
PRICE (1 PCS)		RETAIL € 19,90		

TUBE LED BULB



Like all its Zuiver Bulb siblings, Bulb Tube LED was meant to stay in sight!

Tube shaped clear glass bulb
E27, 2 watt LED, 138 lumen, 2700 Kelvin
Not suitable for dimmer
Dimensions 30x185 mm (Ø x H)
Energy efficiency class: A+ (Energylabel 5)

ZUIVER-CODE	GTIN-CODE	ITEM NAME			
5600003	8718548026230	BULB TUBE LED			
PACKING	12 PCS/CTN	ORDER QTY: 12 PCS			
QTY	CTN SIZE (CM)	CBM	NW (KG)	GW (KG)	
1	3,3x3,3x19	0,0002	0,052	0,075	
12	15,5x11,5x21	0,0037	0,63	1,2	
PRICE (1 PCS)				RETAIL € 19,90	

MIRROR LED BULB



O, how we missed the good old half chrome bulb. Look at our huge one! We made it bigger and better using modern LED technique!

Globe shaped clear & mirror glass bulb
E27, 4 watt LED, 289 lumen, 2700 Kelvin
Not suitable for dimmer
Dimensions 95x140 mm (Ø x H)
Energy efficiency class: A+ (Energylabel 6)

ZUIVER-CODE	GTIN-CODE	ITEM NAME			
5600004	8718548026247	BULB MIRROR LED			
PACKING	12 PCS/CTN	ORDER QTY: 12 PCS			
QTY	CTN SIZE (CM)	CBM	NW (KG)	GW (KG)	
1	10x10x14,5	0,00145	0,055	0,095	
12	42x32x17	0,0228	0,65	1,5	
PRICE (1 PCS)				RETAIL € 27,50	

GLOBE LED BULB



A great bulb can never be too big! For an extra effect we inserted several filament-looking LED's.

Globe shaped clear glass bulb
E27, 2 watt LED, 138 lumen, 2700 Kelvin
Not suitable for dimmer
Dimensions 125x176 mm (Ø x H)
Energy efficiency class: A+ (Energylabel 5)

ZUIVER-CODE	GTIN-CODE	ITEM NAME			
5600005	8718548026254	BULB GLOBE LED			
PACKING	6 PCS/CTN	ORDER QTY: 6 PCS			
QTY	CTN SIZE (CM)	CBM	NW (KG)	GW (KG)	
1	13x13x19	0,0032	0,094	0,13	
6	40,5x27,5x21	0,023	0,56	1,2	
PRICE (1 PCS)				RETAIL € 27,50	



HOME DECO







BINK TIME NEW

There is something vintage chic about a desk clock. With the arrival of the computer they have unfortunately disappeared from our lives. The computer now tells us the time, usually right there in the upper right corner. How BORING! Now you can spice up your workspace again with an ultra-stylish little desk clock. We present: Bink Time!

Silent table clock in polyresin
In concrete look finish or copper plated
Black anodized aluminium hands
Dimensions: 10,5x4 cm
Batteries 1x AA(not included)



ZUIVER-CODE	GTIN-CODE	ITEM NAME		
8500036	8718548030701	CLOCK BINK TIME CONCRETE		
8500037	8718548030718	CLOCK BINK TIME COPPER		
PACKING	4 PCS/CTN	ORDER QTY: 4 PCS		
QTY	CTN SIZE (CM)	CBM	NW (KG)	GW (KG)
1	15x15x8,5	0,0019	0,29	0,34
4	31,5x16x19	0,0096	1,18	1,3
PRICE CONCRETE (1 PCS)		RETAIL € 21,00		
PRICE COPPER (1 PCS)		RETAIL € 24,95		

DOBLO TIME NEW

Our new clock Doblo Time is ideal for people who love multipurpose things. Something to tell you the time, store your pens, look classy but hip and is economical all at the same time? Yes, table clock Doblo Time can do all these things! Desk clocks these days are hard to find and if you find one it tends to be very lame or ridiculously expensive. So Zuiver decided to make one which is not only suitable for trendy CEO's. Although we are sure they will love Doble Time as well...

Silent table clock in polyresin in concrete look finish
Copper anodized aluminium hands
Dimensions: 15,5x4,5x10,5 cm
Batteries 1x AA(not included)



ZUIVER-CODE	GTIN-CODE	ITEM NAME		
8500038	8718548030725	CLOCK DOBLO TIME		
PACKING	4 PCS/CTN	ORDER QTY: 4 PCS		
QTY	CTN SIZE (CM)	CBM	NW (KG)	GW (KG)
1	20,5x14,5x9	0,0027	0,54	0,66
4	30,5x21,5x20	0,0133	2,31	2,42
PRICE (1 PCS)		RETAIL € 27,50		



TIKTAK TIME

In clock Tiktak Time we tried to combine modern and classical details. The oldest reference is in its metal pendulum, which comes in copper, brass or black. For the face of the clock we were inspired by designs from the fifties. And of course the lightweight concrete is totally inspired by the latest trends. That makes Tiktak Time possibly the most time telling clock ever...

Concrete clock with aluminium pendle and hands, anodized in copper, brass or black
 Dimensions: 15,5x37,5x4 cm (Ø x H)
 Batteries: 1xAA (not included)
 Note: Mix set = 2x each colour

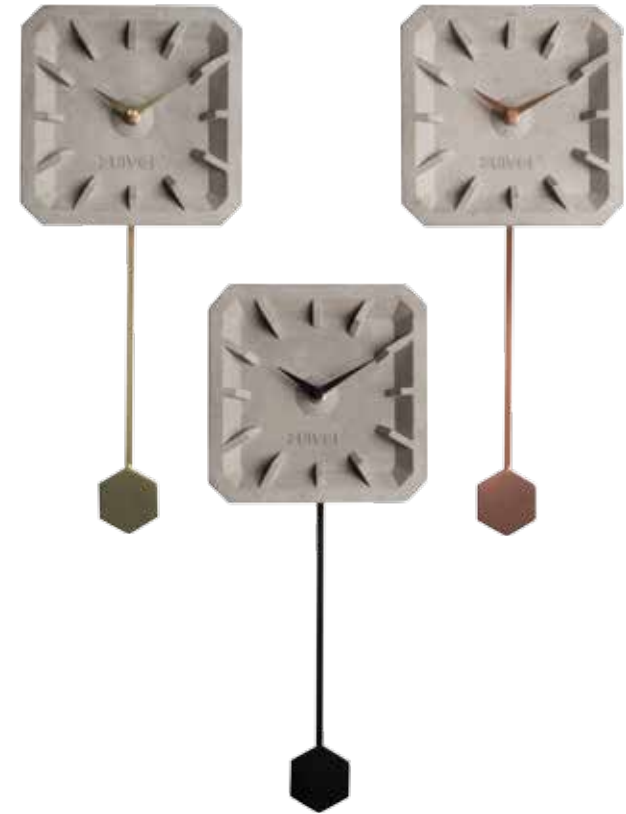

ZUIVER-CODE	GTIN-CODE	ITEM NAME		
8500029	8718548024694	CLOCK TIKTAK TIME COPPER		
8500030	8718548024717	CLOCK TIKTAK TIME BRASS		
8500031	8718548024731	CLOCK TIKTAK TIME BLACK		
PACKING	6 PCS/CTN	ORDER QTY: 6 PCS		
QTY	CTN SIZE (CM)	CBM	NW (KG)	GW (KG)
1	27x22,5x9	0,005	0,87	1,17
6	47,5x28,3x31	0,042	5,22	7,75
PRICE (1 PCS)			RETAIL € 49,00	
ZUIVER-CODE	GTIN-CODE	ITEM NAME		
8500032	8718548024755	CLOCK TIKTAK TIME MIX SET OF 6		
PACKING	1 PCS/CTN (SET OF 6)			
QTY	CTN SIZE (CM)	CBM	NW (KG)	GW (KG)
1	27x22,5x9	0,005	0,87	1,17
6	47,5x28,3x31	0,042	5,22	7,75
PRICE (1 SET)			RETAIL € 294,00	



HOME DECO

ZUIVER° COLLECTION 2017
 NL RETAIL PRICES INCL. VAT



CONCRETE TIME

So imagine this: a sweaty, warm, late afternoon in Guangzhou, China. We were visiting one of our suppliers. A clock specialist. During our visit, whilst talking, one of our designers suddenly got struck by clock-geniusosity. "Light weight concrete with 3D numbers!" was his vision. The clockmaker added coloured aluminium hands for the finishing touch and we named the result Concrete Time. Also cool right?

Concrete clock
 Aluminium hands in orange or black
 Dimensions: 31,6x5 cm (Ø x H)
 Batteries: 1xAA (not included)

The colours may vary slightly, so each clock is unique.



ZUIVER-CODE	GTIN-CODE	ITEM NAME		
8500027	8718548023864	CLOCK CONCRETE TIME ORANGE		
8500028	8718548024199	CLOCK CONCRETE TIME BLACK		
PACKING	2 PCS/CTN	ORDER QTY: 2 PCS		
QTY	CTN SIZE (CM)	CBM	NW (KG)	GW (KG)
1	37,5x36x9,7	0,013	2	2,5
2	38,5x37,5x21	0,03	4,2	5,5
PRICE (1 PCS)			RETAIL € 69,00	

CERAMIC TIME

Make no mistake: All our clocks are designed by Zuiver. As a reminder we have signed our Ceramic Clock with our brand signature. And, yes, that's right, you've read 'ceramic clock'. A clock made of ceramic. Not a very common material for a clock, but then again, we are not very common either!

Ceramic porcelain wall clock, in 2 colour combo's:

- PU-lacquered in blue with white hands
- PU-lacquered in green with red golden hands

Dimensions: 35x10 cm (Ø x H)
 Batteries: 1xAA (not included)



ZUIVER-CODE	GTIN-CODE	ITEM NAME		
8500023	8718548023451	CLOCK CERAMIC TIME BLUE		
8500024	8718548023468	CLOCK CERAMIC TIME GREEN		
PACKING	1 PCS/CTN	ORDER QTY: 2 PCS		
QTY	CTN SIZE (CM)	CBM	NW (KG)	GW (KG)
1	43,5x41x15	0,027	1,6	2,2
2	45x31,5x42,5	0,06	3,2	5,1
PRICE (1 PCS)			RETAIL € 69,00	



MARBLE TIME

Marble and gold. Ow, how they combine beautifully... It is like a match made in heaven. Gold coloured hands on a perfectly shaped slab of marble. Just look at it. See? Who needs numbers? No one.... Just pick your favourite colour of marble: white, grey, green or black. Go for it and let Marble Time shine on your wall...

Marble wall clock
 Gold-coloured aluminium hands
 Dimensions: 25x4,5 cm (Ø x H)
 Batteries: 1xAA (not included)

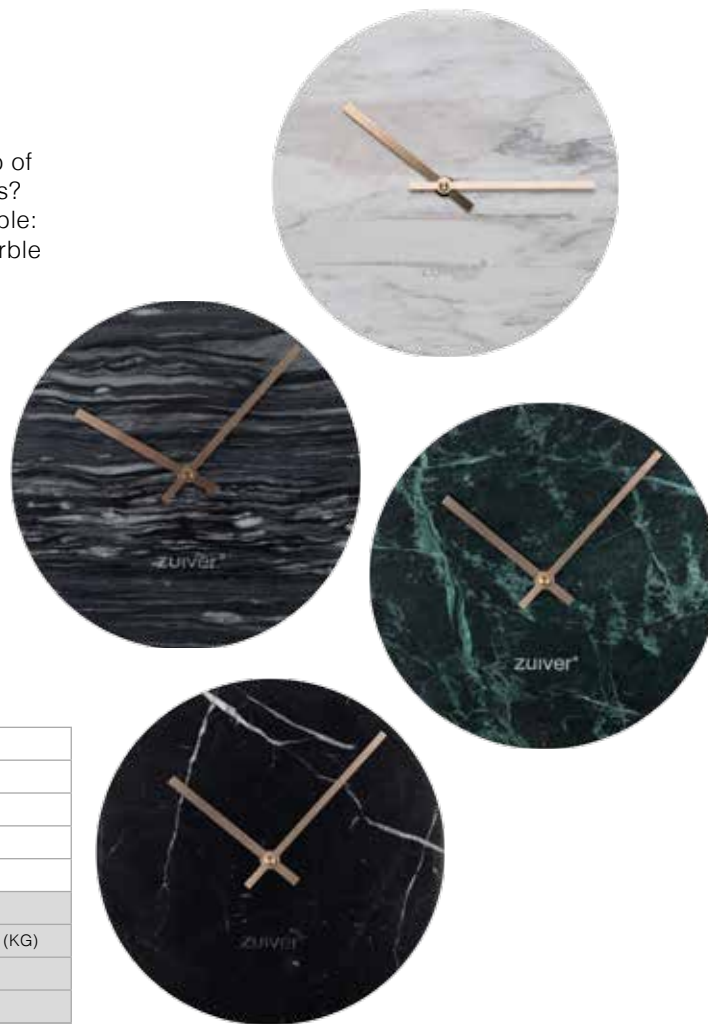

ZUIVER-CODE	GTIN-CODE	ITEM NAME		
8500025	8718548023475	CLOCK MARBLE TIME WHITE		
8500033	8718548026827	CLOCK MARBLE TIME BLACK		
8500034	8718548026841	CLOCK MARBLE TIME GREEN		
8500035	8718548029170	CLOCK MARBLE TIME GREY		
PACKING	3 PCS/CTN	ORDER QTY: 3 PCS		
QTY	CTN SIZE (CM)	CBM	NW (KG)	GW (KG)
1	32,5x30x7,5	0,007	2	2,6
3	34x24x31,5	0,026	6,2	7,8
PRICE (1 PCS)			RETAIL € 69,00	





OSB TIME

How tough looking can a wall clock be? That question made us laugh until the Zuiver design team came up with the OSB Clock. The perfect companion for our OSB table. Not only because of the material we used, but look at those hands, they match the table legs. Details, details. We love them!

OSB dial with white painted hours
 White aluminum hands
 Dimensions: 50x4,5 cm (Ø x H)
 Batteries: 1xAA (not included)



ZUIVER-CODE	GTIN-CODE	ITEM NAME		
8500026	8718548023482	CLOCK OSB TIME WHITE		
PACKING	1 PCS/CTN	ORDER QTY: 3 PCS		
QTY	CTN SIZE (CM)	CBM	NW (KG)	GW (KG)
1	56,5x53x7	0,021	1,32	2,6
3	58x21x55,5	0,067	3,96	6,6
PRICE (1 PCS)		RETAIL € 39,95		

TIME BANDIT

Our Time Bandit is very in sync with modern times. This clock comes in a distinguished grey. One could say, only for gentlemen. But that would be a little sexist. Because our Time Bandit feels at home wherever it is.

Grey case with grey dial, hands in black
 Dimensions: 60x5,5 cm (Ø x H)
 Batteries: 1xAA (not included)



ZUIVER-CODE	GTIN-CODE	ITEM NAME		
8500007	8718548002456	CLOCK TIME BANDIT GREY/GREY		
PACKING	1 PCS/CTN			
QTY	CTN SIZE (CM)	CBM	NW (KG)	GW (KG)
1	64x64x8,5	0,0348	4,88	5,8
PRICE (1 PCS)		RETAIL € 139,00		



PULP TIME

Time will fly by with our lightweight and very cool Paper Pulp Wall Clock. Ok, in all honesty... that was just a catchy phrase. In fact this new cool design by Zuiver will do just the opposite. Because, as you know, time slows down considerably when you keep checking it. And this clock is so cool, you won't be able to keep your eyes off of it. So...

Wall clock, round or square
 100% recycled paper pulp
 Natural or black, with matte black aluminium hands
 Dimensions round: 46x5,5 cm (Ø x H)
 Dimensions square: 36x36x7 cm (LxWxH)
 Batteries: 1xAA (not included)



ZUIVER-CODE	GTIN-CODE	ITEM NAME		
8500021	8718548023437	CLOCK PULP TIME ROUND BEIGE		
8500022	8718548023444	CLOCK PULP TIME ROUND BLACK		
PACKING	4 PCS/CTN	ORDER QTY: 4 PCS		
QTY	CTN SIZE (CM)	CBM	NW (KG)	GW (KG)
1	50,5x48x6	0,015	0,35	0,65
4	52x25,5x49,5	0,06	1,4	3,4
PRICE (1 PCS)		RETAIL € 34,95		

ZUIVER-CODE	GTIN-CODE	ITEM NAME		
8500019	8718548023413	CLOCK PULP TIME SQUARE BEIGE		
8500020	8718548023420	CLOCK PULP TIME SQUARE BLACK		
PACKING	4 PCS/CTN	ORDER QTY: 4 PCS		
QTY	CTN SIZE (CM)	CBM	NW (KG)	GW (KG)
1	40,5x38x8	0,012	0,32	0,6
4	42x33,5x39,5	0,05	1,28	3
PRICE (1 PCS)		RETAIL € 29,95		



PINNACLE

Our inspiration can come from anything. Sometimes even from the weirdest things. For this coat rack it was the ancient game of Mikado. We gave this Asian agility game a Scandinavian feel by using blond wood and a white or dark grey detail. Naturally we had to scale everything up a bit. The result is this free-standing coat rack. We called it Pinnacle.

Solid pine wood, natural lacquered
 Powdercoated steel joint
 Maximum weight load: 23 kg
 Dimensions: 56x59x176 cm (WxDxH)



ZUIVER-CODE	GTIN-CODE	ITEM NAME		
7100006	8718548026391	COAT RACK PINNACLE WHITE		
7100007	8718548026407	COAT RACK PINNACLE DARK GREY		
PACKING	1 PCS/CTN			
QTY	CTN SIZE (CM)	CBM	NW (KG)	GW (KG)
1	129x23x16	0,047	2,8	3,9
PRICE (1 PCS)			RETAIL € 99,50	



WOODEN TIP

Sometimes all a good design needs is a touch of wood. That's why we included the Wooden tips in coat rack Wooden Tip. Simple right?

Metal coat rack with 8 hooks
White lacquered with rubber wood tips
Dimensions: 39,5x175,5 cm (Ø x H)



ZUIVER-CODE	GTIN-CODE	ITEM NAME		
9000156	8718548007680	COAT RACK WOODEN TIP WHITE		
PACKING	1 PCS/CTN			
QTY	CTN SIZE (CM)	CBM	NW (KG)	GW (KG)
1	79x36,5x9	0,026	5,5	6,5
PRICE (1 PCS)			RETAIL € 99,00	

TABLE TREE

We love multifunctional furniture. So we designed Table Tree. Not only will Table Tree take care of your stray coats and scarves, it will also be a refuge for pocket change, keys, wallets and even mail. Note the wood and white combo. It's almost a shame to use Table Tree. It looks so nice, naked and all.

Rubber wood coat rack (5 hooks) with 15 mm MDF table top
Combination of natural and white finish
Dimensions: 40x169 cm (Ø x H)

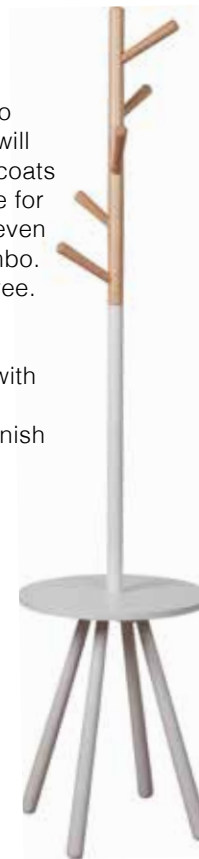

ZUIVER-CODE	GTIN-CODE	ITEM NAME		
7100005	8718548014732	COAT RACK TABLE TREE WHITE		
PACKING	1 PCS/CTN			
QTY	CTN SIZE (CM)	CBM	NW (KG)	GW (KG)
1	46x67x7,5	0,017	3,8	4,4
PRICE (1 PCS)			RETAIL € 99,00	

Zuivers Rack Ladder and Leaning Mirror are like a unmarried couple; They belong together, but do not share a family name. So, I guess it's okay to just buy the magazine rack and not the mirror. But hey, let's be honest, aren't they a cute couple? Leaning together... So carelessly on the wall... In your hall... Carrying your daily newspapers and magazines... While you check your lipstick... Or tie... Depending on your sex... O, well, you get the picture, right?



RACK LADDER

White powdercoated steel ladder
 Rubberwood feet, natural lacquered
 Dimensions: 37/54(top/bottom)x2x175 cm (WxDxH)
 For decoration only

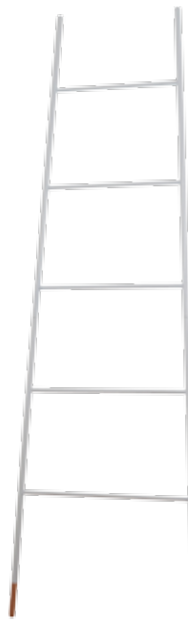

ZUIVER-CODE	GTIN-CODE	ITEM NAME		
7900004	8718548018969	LADDER RACK WHITE		
PACKING	1 PCS/CTN			
QTY	CTN SIZE (CM)	CBM	NW (KG)	GW (KG)
1	91x55x6	0,03	1,9	3
PRICE (1 PCS)		RETAIL € 69,00		

LEANING MIRROR

Mirror in white powdercoated steel frame (2 cm tube)
 Rubberwood feet, natural lacquered
 Dimensions: 31/48(top/bottom)x4,9x171 cm (WxDxH)



ZUIVER-CODE	GTIN-CODE	ITEM NAME		
8100003	8718548018976	MIRROR LEANING WHITE		
PACKING	1 PCS/CTN			
QTY	CTN SIZE (CM)	CBM	NW (KG)	GW (KG)
1	165x49,5x6	0,049	5,03	6,3
PRICE (1 PCS)		RETAIL € 89,00		



ROUND WALL

Ok ladies, who recognizes this: You're running out the door, you quickly check yourself in a mirror and see that your hair is in need of a comb and your lips are in need of lipstick. But where are they? Round Wall helps you out right there! You can easily house a comb and a lipstick in its fun compartment. And for you gents, no worries: Round Wall is also pretty when empty.

5 mm mirror with 12 mm plywood frame
 Oak veneer, natural colour
 Dimensions '40: 40x8 cm (Ø x D)
 Dimensions '60: 60x8 cm (Ø x D)



ZUIVER-CODE	GTIN-CODE	ITEM NAME		
8100002	8718548007659	MIRROR ROUND WALL '40		
PACKING	1 PCS/CTN			
QTY	CTN SIZE (CM)	CBM	NW (KG)	GW (KG)
1	46x46x14,5	0,031	2,6	3,16
PRICE (1 PCS)			RETAIL € 79,00	

ZUIVER-CODE	GTIN-CODE	ITEM NAME		
8100004	8718548019270	MIRROR ROUND WALL '60		
PACKING	1 PCS/CTN			
QTY	CTN SIZE (CM)	CBM	NW (KG)	GW (KG)
1	67x65x13	0,057	6	7
PRICE (1 PCS)			RETAIL € 99,00	



You want to be cooler than your neighbours?
 Just bring out the Zuiver Be Cool Ice Chest and
 let the BBQ games begin! This is undeniably the
 coolest cooler in the world. Just fill this baby up with
 ice cubes, throw in those brewskis, place it outside
 and casually pop one open with the handy dandy
 opener on the side. Bam!



BE COOL NEW

Iron sheet cover and legs, black powder coated
 Bottle opener with cap catcher attached
 White polypropylene cooler with PU-foam
 PVC & iron castors, one with lock
 Maximum capacity: 70 litres
 Maximum weight load: 55 kg
 Dimensions: 91x39x84,5 cm (WxDxH)
 Cooler unit: 78x39x35,5 cm (WxDxH)
 (measured on the outside, without handles)



bottle opener



threaded drain plug



ZUIVER-CODE	GTIN-CODE	ITEM NAME		
7900007	8718548031678	COOLER BE COOL		
PACKING	1 PCS/CTN			
QTY	CTN SIZE (CM)	CBM	NW (KG)	GW (KG)
1	81,5x40,5x40	0,13	16	18
PRICE (1 PCS)			RETAIL € 249,00	

What better way to display your most valued possessions than these Zuiver Fad wall shelves? Of course, as you can expect from us, Fad is no ordinary wall shelf. It's a posh version with trendy natural marble shelves. To make it even classier we chose buffalo leather belts! We bet you'll steal the show with Zuiver Fad on your wall.



FAD NEW

13-15 mm marble shelf
Iron shelf support with brown buffalo leather strap
Dimensions: 50x16x32 (WxDxH)
Maximum weight load: 10 kg



ZUIVER-CODE	GTIN-CODE	ITEM NAME		
7600001	8718548029361	WALL SHELF FAD MARBLE WHITE		
7600002	8718548029378	WALL SHELF FAD MARBLE GREY		
7600003	8718548029385	WALL SHELF FAD MARBLE GREEN		
PACKING	1 PCS/CTN			
QTY	CTN SIZE (CM)	CBM	NW (KG)	GW (KG)
1	57x20,5x10,5	0,0123	3,8	4,2
PRICE (1 PCS)			RETAIL € 79,00	

MARBLE TRAY

Impress your friends by serving them a cappuccino in style, just like the most trendy coffeehouse out there. You don't even have to be a great barista anymore! Just place a hip glass or coffee cup in the circular section and some rustic cane sugar lumps and a tiny spoon in the rectangle one and go knock their coffee socks off. Try to keep your cool though. Go like: "What? Oh, this little marble Zuiver tray you mean? Yeah, nice huh?"

Marble serving tray
Dimensions: 22x10x1,5 cm (WxDxH)



ZUIVER-CODE	GTIN-CODE	ITEM NAME		
8800007	8718548029088	TRAY MARBLE WHITE		
8800008	8718548029101	TRAY MARBLE GREY		
8800009	8718548029125	TRAY MARBLE GREEN		
PACKING	1 PCS/CTN	ORDER QTY: 6 PCS		
QTY	CTN SIZE (CM)	CBM	NW (KG)	GW (KG)
1	27,9x14,5x4,5	0,0018	1,6	1,7
6	30x29,5x16	0,014	9,6	10,6
PRICE (1 PCS)			RETAIL € 29,90	



NITO



Nice matte ceramic and pretty textured glazes meet in the middle of these pretty Zuiver vases. Of course you're allowed to put flowers in them, but they don't necessarily need any! Our Nito vases shine by themselves. They come in different colours and shapes. Group them together and experience how they embody the ultimate finishing touch!

Grey coloured ceramic with glazed diamond pattern
 Dimensions M: 19x23 cm (Ø x H), opening: 12 cm Ø
 Dimensions L: 14x35,5 cm (Ø x H), opening: 6,5 cm Ø
 Dimensions XL: 21,5x40 cm (Ø x H), opening: 14 cm Ø



ZUIVER-CODE	GTIN-CODE	ITEM NAME		
8200025	8718548030930	VASE NITO XL MOSS		
8200026	8718548030947	VASE NITO XL CLAY		
PACKING	4 PCS/CTN	ORDER QTY: 4 PCS		
QTY	CTN SIZE (CM)	CBM	NW (KG)	GW (KG)
1	25,5x25,5x44	0,029	3,465	3,7
4	53x53x47,5	0,133	13,86	16
PRICE (1 PCS)		RETAIL € 44,00		
ZUIVER-CODE	GTIN-CODE	ITEM NAME		
8200027	8718548030954	VASE NITO L MOSS		
8200028	8718548030961	VASE NITO L CLAY		
PACKING	8 PCS/CTN	ORDER QTY: 8 PCS		
QTY	CTN SIZE (CM)	CBM	NW (KG)	GW (KG)
1	18x18x40	0,013	1,67	1,7
8	73,5x37,5x43	0,119	13,36	15
PRICE (1 PCS)		RETAIL € 22,00		

ZUIVER-CODE	GTIN-CODE	ITEM NAME		
8200029	8718548030978	VASE NITO M MOSS		
8200030	8718548030985	VASE NITO M CLAY		
PACKING	6 PCS/CTN	ORDER QTY: 6 PCS		
QTY	CTN SIZE (CM)	CBM	NW (KG)	GW (KG)
1	22x22x28	0,014	1,515	1,665
6	69x46,5x30,5	0,098	9,09	11
PRICE (1 PCS)		RETAIL € 22,00		



FIELD FLOWER

O, yes we did it! We designed a glass vase, blown by hand, which doesn't need flowers to be pretty. Our vase Field Flower is a real stand alone. Sure, a nice springy branch or single flower can add something to it. But it will be like adding lipstick to Mona Lisa: She just doesn't need it!

Mouth blown vase with embossed Zuiver logo
 Mouth of the vase made by hand
 Non tempered glass, clear or spray painted
 Dimensions: 30x48 cm (Ø x H)



ZUIVER-CODE	GTIN-CODE	ITEM NAME		
8200013	8718548025035	VASE FIELD FLOWER CLEAR		
8200014	8718548025042	VASE FIELD FLOWER TEAL		
8200015	8718548025059	VASE FIELD FLOWER MUSTARD		
PACKING	1 PCS/CTN			
QTY	CTN SIZE (CM)	CBM	NW (KG)	GW (KG)
1	36x36x54	0,07	2,2	3,7
PRICE (1 PCS)			RETAIL € 59,00	

BLOOM NEW

Vase Bloom is a very special vase. It can put one single flower in the absolute spotlight and make it shine like a big bouquet all on its own! We all need such an elegant little vase in our life, don't you agree? In fact we should all see to it, that everyone around us owns one! Preferably this Zuiver one...

Powder coated aluminium
 Dimensions: 11x16 cm (Ø x H)
 Opening: 2,75 cm Ø



ZUIVER-CODE	GTIN-CODE	ITEM NAME		
8200022	8718548030398	VASE BLOOM BLACK		
8200023	8718548030411	VASE BLOOM SAND		
8200024	8718548030435	VASE BLOOM GREY		
PACKING	6 PCS/CTN	ORDER QTY: 6 PCS		
QTY	CTN SIZE (CM)	CBM	NW (KG)	GW (KG)
1	13x12,5x18	0,00293	0,550	0,75
6	42x16x39	0,0262	3,3	4,8
PRICE (1 PCS)			RETAIL € 12,95	



BLOB NEW

Bouquets filled with long roses or shorter and wider bouquets? Zuiver has a vase Blob for every type of bouquet and all kinds of flowers! Blob large or XL, it doesn't matter: Both will elegantly accentuate all types of flowers but just as well make a statement without any branches or roses!

Powder coated iron

Dimensions large: 18x34 cm (Ø x H), opening 15 cm Ø

Dimensions XL: 23x27 cm (Ø x H), opening 21 cm Ø



ZUIVER-CODE	GTIN-CODE	ITEM NAME		
8200016	8718548030190	VASE BLOB LARGE BLACK		
8200017	8718548030206	VASE BLOB LARGE SAND		
8200018	8718548030213	VASE BLOB LARGE GREY		
PACKING	1 PCS/CTN			
QTY	CTN SIZE (CM)	CBM	NW (KG)	GW (KG)
1	22x22x38	0,018	1	1,6
PRICE (1 PCS)			RETAIL € 29,95	

ZUIVER-CODE	GTIN-CODE	ITEM NAME		
8200019	8718548030220	VASE BLOB XL BLACK		
8200020	8718548030237	VASE BLOB XL SAND		
8200021	8718548030244	VASE BLOB XL GREY		
PACKING	1 PCS/CTN			
QTY	CTN SIZE (CM)	CBM	NW (KG)	GW (KG)
1	27x27x32	0,023	1,3	2
PRICE (1 PCS)			RETAIL € 35,00	



PAWN

NEW

Tea light or proper candle? It can be a tough call. Some situations ask for the first, others need a more classic touch with a long slender candle. Choices, choices, but Zuiver helps you with this one. With candle holder Pawn you only need one candlestick, whichever choice you make. The bigger notch is perfect for tea lights, remove it and... ta-dah, a candlestick holder underneath! No, no...No need to thank us. Just enjoy!

Powder coated aluminium

Candle openings: 2,2 cm Ø and 4,2 cm Ø

Suitable for both dinner candle and tea light

Dimensions: 7x17 cm (Ø x H)



ZUIVER-CODE	GTIN-CODE	ITEM NAME		
8300004	8718548030275	CANDLE HOLDER PAWN BLACK		
8300005	8718548030299	CANDLE HOLDER PAWN SAND		
8300006	8718548030312	CANDLE HOLDER PAWN GREY		
PACKING	6 PCS/CTN	ORDER QTY: 6 PCS		
QTY	CTN SIZE (CM)	CBM	NW (KG)	GW (KG)
1	9x8,5x20	0,0015	0,35	0,42
6	30x12x41	0,015	2,1	3,1
PRICE (1 PCS)			RETAIL € 12,50	

HEXAGON

NEW

Of course you can serve nuts or olives in our Tray Hexagon. Which is not only extremely practical but also stunningly pretty! You can use it in the kitchen, but imagine how this divided tray can show its beauty when holding your rings, watch or other jewellery... Good thing it comes in different colours; Two in the kitchen cabinet and one in the bathroom!

Powder coated aluminium

Dimensions: 27x18,5x4 cm (WxDxH)

Opening: bottom 4 cm Ø and top 8,5 cm Ø



ZUIVER-CODE	GTIN-CODE	ITEM NAME		
8800010	8718548030336	TRAY HEXAGON BLACK		
8800011	8718548030350	TRAY HEXAGON SAND		
8800012	8718548030374	TRAY HEXAGON GREY		
PACKING	6 PCS/CTN	ORDER QTY: 6 PCS		
QTY	CTN SIZE (CM)	CBM	NW (KG)	GW (KG)
1	28x5,5x21	0,0032	0,5	0,65
6	30x19x42	0,024	3	4,4
PRICE (1 PCS)			RETAIL € 16,50	



ASTER PLAID

Of course you could knit your own comfy soft throw blanket. If that is the case, please skip this page. Because after seeing our throw Aster you'll come to the conclusion that you've been knitting for, well, nothing... Zuiver beat you to it. The perfect and comfortable sized knitted throw, it is right here. And to make matters even better this series has a throw pillow as well!

100% acryl knitted throw blanket with orange stitching detail
Dimensions: 170x130 cm (LxW)



ZUIVER-CODE	GTIN-CODE	ITEM NAME			
8700001	8718548027022	PLAID ASTER BLACK			
8700002	8718548027046	PLAID ASTER GREY			
8700003	8718548027060	PLAID ASTER IVORY			
8700007	8718548028845	PLAID ASTER BLUE			
PACKING	4 PCS/CTN	ORDER QTY: 4			
QTY	CTN SIZE (CM)	CBM	NW (KG)	GW (KG)	
4	40x30x30	0,036	3,2	4	
PRICE (1 PCS)			RETAIL € 69,50		

ASTER PILLOW

Complete your newly styled lounge area with our throw pillow Aster. It is finely knitted from a comfy soft acrylic-mix and has a lovely orange detail. It is the perfect companion for throw blanket Aster. Just pick your favourite colour. Or simply combine them...

100% acryl knitted front with orange stitching detail
Grey cotton back
Polyester fibre filling
Dimensions: 60x30 cm (LxW)



ZUIVER-CODE	GTIN-CODE	ITEM NAME			
8600032	8718548027084	PILLOW ASTER BLACK			
8600033	8718548027107	PILLOW ASTER GREY			
8600034	8718548027121	PILLOW ASTER IVORY			
8600042	8718548028821	PILLOW ASTER BLUE			
PACKING	6 PCS/CTN	ORDER QTY: 6			
QTY	CTN SIZE (CM)	CBM	NW (KG)	GW (KG)	
6	30x60x15	0,027	2,7	3,5	
PRICE (1 PCS)			RETAIL € 29,50		



MIMOSA PLAID

Is it winter yet? Because we can't wait to cuddle up under our throw Mimosa! With its subtle orange detail it is a blanket to long for. It's warm and soft and when not in use it really styles up the couch. Especially when combined with matching throw pillow Mimosa!

Woven throw blanket with fringes and orange stitching detail
60% acryl, 20% wool, 20% nylon
Dimensions: 170x130 cm (LxW)



ZUIVER-CODE	GTIN-CODE	ITEM NAME		
8700004	8718548027145	PLAID MIMOSA YELLOW		
8700005	8718548027169	PLAID MIMOSA GREY		
8700006	8718548027183	PLAID MIMOSA GREEN		
PACKING	4 PCS/CTN	ORDER QTY: 4		
QTY	CTN SIZE (CM)	CBM	NW (KG)	GW (KG)
4	40x30x20	0,024	1,8	2,6
PRICE (1 PCS)		RETAIL € 69,50		

MIMOSA PILLOW

Throw Pillow Mimosa is all about delicacy. The fabric we used for this throw pillow is soft, the waffle pattern small and the orange thread creates a subtle detail. Pillow Mimosa comes in several colours and, needless to say, goes very well together with throw blanket Mimosa...

Woven front with orange stitching detail
60% acryl, 20% wool, 20% nylon
Grey cotton back
Polyester fibre filling
Dimensions: 45x45 cm (LxW)



ZUIVER-CODE	GTIN-CODE	ITEM NAME		
8600035	8718548027206	PILLOW MIMOSA YELLOW		
8600036	8718548027220	PILLOW MIMOSA GREY		
8600037	8718548027244	PILLOW MIMOSA GREEN		
PACKING	6 PCS/CTN	ORDER QTY: 6		
QTY	CTN SIZE (CM)	CBM	NW (KG)	GW (KG)
6	45x45x15	0,03	3	3,8
PRICE (1 PCS)		RETAIL € 29,50		



COSIMA

There is always something cheerful about the polka dot, don't you agree? It brings a smile and something playful into the mix. No wonder we immediately fell in love with this jacquard knit with its pretty coloured teal blue and mustard yellow dots, and we decided to use it in a very comfortable throw blanket. Throw Cosima is the result.

100% acryl knitted throw blanket
 Dimensions: 170x130 cm (LxW)



ZUIVER-CODE	GTIN-CODE	ITEM NAME		
8700008	8718548028869	PLAID COSIMA BLUE		
8700009	8718548028883	PLAID COSIMA YELLOW		
PACKING	4 PCS/CTN	ORDER QTY: 4		
QTY	CTN SIZE (CM)	CBM	NW (KG)	GW (KG)
4	40x30x30	0,036	3,2	4
PRICE (1 PCS)		RETAIL € 69,50		

GRAPHIC PILLOW

Oowh, look at that; a pillow with a matching carpet! That calls for subtle styling, of any room! Pillow Graphic has a nice black and white pattern (what's in the name). And because we at Zuiver like details, we added a black pompon. Pillow Graphic is a comfortable rectangular pillow. The fabric is made of 100% cotton. Needless to say it matches perfectly with our Graphic rug.

Hand-woven cover, 100% cotton
 Printed dessin
 Black pompons
 Polyester fibre filling
 Dimensions: 60x40 cm (LxW)



ZUIVER-CODE	GTIN-CODE	ITEM NAME		
8600018	8718548023635	PILLOW GRAPHIC BLACK		
PACKING	5 PCS/CTN	ORDER QTY: 5		
QTY	CTN SIZE (CM)	CBM	NW (KG)	GW (KG)
5	42x62x18	0,047	5 (5x1)	6
PRICE (1 PCS)		RETAIL € 34,50		



SARONA

NEW

For pillow Sarona we were inspired by the old weave technique of velvet jacquard. In the weaving process we let threads in contrasting colours appear and disappear in a random looking pattern. The result is a fabric with a nice distressed look. As if it was sanded, but that would have made the pillow hard and rough, while Sarona is über soft. We liked the result so much we used it in several colour combinations and made all of them into a nice throw pillow.

Fabric: 63% viscose, 24% polyester,
8% linen, 5% cotton
18.000 Martindale, colour fastness 4-5
Filling: 100% polyether
Dimensions: 45x45 (LxW)

ZUIVER-CODE	GTIN-CODE	ITEM NAME		
8600043	8718548030008	PILLOW SARONA VINTAGE BLUE		
8600044	8718548030022	PILLOW SARONA OCHRE YELLOW		
8600045	8718548030046	PILLOW SARONA MOSS GREEN		
8600046	8718548030060	PILLOW SARONA NIGHT BLUE		
PACKING	6 PCS/CTN	ORDER QTY: 6 PCS		
QTY	CTN SIZE (CM)	CBM	NW (KG)	GW (KG)
6	39x39x55	0,084	3,84	4,7
PRICE (1 PCS)			RETAIL € 35,00	





ZIGGY PILLOW

Yellow or black pompons? That's the question. With our Pillow Ziggy we give you the choice! Yes, yes you are welcome... And you know what? We also designed a matching rug for you: Carpet Ziggy! But hold your horses, we are not done yet. Take a look at Pillow and Carpet Graphic... Imagine how they will combine with Ziggy... We know... It's so good, it's almost to good to be true.

Hand-woven cover, 100% cotton
With black or yellow pompons
Polyester fibre filling
Dimensions: 50x50 cm (LxW)



ZUIVER-CODE	GTIN-CODE	ITEM NAME		
8600019	8718548023673	PILLOW ZIGGY BLACK		
8600020	8718548023697	PILLOW ZIGGY YELLOW		
PACKING	5 PCS/CTN	ORDER QTY: 5		
QTY	CTN SIZE (CM)	CBM	NW (KG)	GW (KG)
5	52x52x18	0,049	6,5 (5x1,3)	7,5
PRICE (1 PCS)			RETAIL € 34,50	

FOX

The most powerful geometric designs are often set in just two colours: black and white. Just like the patterns from a classic Norwegian sweater. Pillow Fox proves the power of black and white patterns once again. Just like your favourite sweater, Pillow Fox is made from a perfect blend of wool and cotton and in an über comfortable size. Ready to style up any interior!

Front: hand-woven, 50% wool, 30% recycled art silk, 20% cotton
Colour fastness: 2-3
Back: 100% cotton
Polyester fibre filling
Dimensions: 50x50 cm (LxW)



ZUIVER-CODE	GTIN-CODE	ITEM NAME		
8600030	8718548024595	PILLOW FOX		
PACKING	6 PCS/CTN	ORDER QTY: 6		
QTY	CTN SIZE (CM)	CBM	NW (KG)	GW (KG)
1	53x53x3,8	0,011	0,95	0,98
6	53x53x23	0,065	5,7	7,2
PRICE (1 PCS)			RETAIL € 49,50	



MOOSE

Pillow Moose is a special pillow. Not only because of the patterns, inspired by the famous Norwegian sweater. No, there are more reasons. Tell us, how many pillows have a brother from-an-other-mother? He is called Carpet Moose. Yup, we did it. We just had to use this comfy wool-cotton mix with its pretty woven pattern in more than one design. Besides, think how well styled your house will look when your throw pillow and carpet match? Smashing!

Front: hand-woven, 80% wool, 20% cotton
 Colour fastness: 2-3
 Back: 100% cotton
 Polyester fibre filling
 Dimensions: 50x50 cm (LxW)



ZUIVER-CODE	GTIN-CODE	ITEM NAME		
8600031	8718548024618	PILLOW MOOSE		
PACKING	6 PCS/CTN	ORDER QTY: 6		
QTY	CTN SIZE (CM)	CBM	NW (KG)	GW (KG)
1	53x53x3,8	0,011	1,05	1,08
6	53x53x23	0,065	6,3	7,8
PRICE (1 PCS)		RETAIL € 49,50		

SALMON

We at Zuiver have an absolute soft spot for Scandinavian patterns. Patterns like the ones on the famous Norwegian sweaters. We have finally found a way to incorporate them into our interiors: With Pillow Salmon. A nice wool-cotton mix, soft to the touch and warm to the feet. Such a pretty woven fabric, we just had to use it in a pillow and a carpet. Of course they can be bought separately, but imagine how well-balanced your interior will be when your rug and pillow match.....!

Front: hand-woven, 80% wool, 20% cotton
 Colour fastness: 2-3
 Back: 100% cotton
 Polyester fibre filling
 Dimensions: 50x50 cm (LxW)



ZUIVER-CODE	GTIN-CODE	ITEM NAME		
8600029	8718548024571	PILLOW SALMON		
PACKING	6 PCS/CTN	ORDER QTY: 6		
QTY	CTN SIZE (CM)	CBM	NW (KG)	GW (KG)
1	53x53x3,8	0,011	0,85	0,88
6	53x53x23	0,065	5,1	6,6
PRICE (1 PCS)		RETAIL € 49,50		



MONTY PILLOW

Ohh! Doesn't Pillow Monty look comfy!? It makes you long for a cold night curled up in front of the television. Remote within reach, ice cream straight from the carton and lots of pillow Monty's all around you.... ohh! Give us more!

72% viscose, 23% polyester, 5% cotton
 25.000 Martindale, colour fastness 3-4
 Filling: 100% polyether
 Dimensions: 45x45 cm (LxW)



ZUIVER-CODE	GTIN-CODE	ITEM NAME		
8600022	8718548024274	PILLOW MONTY LIGHT BLUE		
8600023	8718548024298	PILLOW MONTY DARK GREY		
8600024	8718548024311	PILLOW MONTY HONEY		
PACKING	6 PCS/CTN	ORDER QTY: 6		
QTY	CTN SIZE (CM)	CBM	NW (KG)	GW (KG)
6	39x39x65	0,099	4,2 (6x0,7)	5,5
PRICE (1 PCS)			RETAIL € 35,00	



DIAMOND PILLOW

Sometimes the right touch of luxury can be found in something simple, like the perfect throw pillow. Our Pillow Diamond masters that quality. Royal Red, Minty Green, Pebble Grey or Emerald Green. It doesn't matter which one of these classy colours you choose. They are equally chic and they combine perfectly with our Diamond Chair which is covered with the same fabric and diamond stitching.

Diamond stitched fabric with piping
 Fabric: 100% polyester, > 25.000 Martindale
 Filling: 100% polyether
 Dimensions: 50x50 cm (LxW)



ZUIVER-CODE	GTIN-CODE	ITEM NAME		
8600038	8718548027350	PILLOW DIAMOND SQUARE ROYAL RED		
8600039	8718548027367	PILLOW DIAMOND SQUARE MINTY GREEN		
8600040	8718548027374	PILLOW DIAMOND SQUARE EMERALD GREEN		
8600041	8718548027381	PILLOW DIAMOND SQUARE PEBBLE GREY		
PACKING	6 PCS/CTN	ORDER QTY: 6		
QTY	CTN SIZE (CM)	CBM	NW (KG)	GW (KG)
6	49x49x62	0,149	1,05	1,5
PRICE (1 PCS)			RETAIL € 39,00	



KEYCOLOUR PILLOW

Our design team adores splashes of colour. We are always looking for colourful products that will make you happy and will empower your space. For this pillow, we used all key colours in just one item. Hence its name: Pillow Keycolour! It is all you need to brighten up a dull seating area or a plain bedcover...

74% viscose, 21% acryl, 5% cotton
 25.000 Martindale, colour fastness 3-4
 Filling: 100% polyether
 Dimensions: 45x45 cm (LxW)



ZUIVER-CODE	GTIN-CODE	ITEM NAME		
8600026	8718548024359	PILLOW KEYCOLOUR		
PACKING	6 PCS/CTN	ORDER QTY: 6		
QTY	CTN SIZE (CM)	CBM	NW (KG)	GW (KG)
6	39x39x65	0,099	4,2 (6x0,7)	5,5
PRICE (1 PCS)			RETAIL € 35,00	



RIDGE PILLOW

We love our Ridge chair Rib fabric so much that we wanted to do more with it. That's how Pillow Ridge was born. And it was a fast delivery. For we just couldn't wait.

Arm cushion in ribcord fabric

Fabric: 88% nylon, 12% polyester, >40.000 Martindale

Filling: 60% duck feathers, 40% polyester fibre

Rectangle in 2 colour settings:

1. Blue 12A, orange 19A, yellow 24 A

2. Cool grey 32 A, white 1A, grey 6A

Dimensions rectangle: 60x30 cm (LxW)

Dimensions square: 50x50 cm (LxW)

Dry clean only

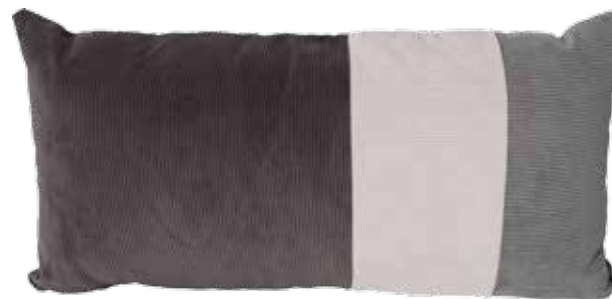

ZUIVER-CODE	GTIN-CODE	ITEM NAME		
8600000	8718548015821	PILLOW RIDGE RECTANGLE COLOUR		
8600001	8718548015838	PILLOW RIDGE SQUARE COLOUR		
8600002	8718548015845	PILLOW RIDGE RECTANGLE GREY		
PACKING	6 PCS/CTN	ORDER QTY: 6		
QTY	CTN SIZE (CM)	CBM	NW (KG)	GW (KG)
6 rectangle	29x60x60	0,104	4,86 (6x0,81)	5,86
6 square	57x57x60	0,195	7,14 (6x1,19)	8,65
PRICE RECTANGLE (1 PCS)			RETAIL € 29,50	
PRICE SQUARE (1 PCS)			RETAIL € 32,50	



HOME DECO

ZUIVER° COLLECTION 2017
NL RETAIL PRICES INCL. VAT



DISPLAYS



NEW CATEGORY

Zuiver doesn't only like to help your customers to decorate their home, but we also like to help our own customers to set up their shop!

The perfect solution to swiftly create a playful and varied look for the shop. A look that can help your customers find their way. Choices can be made neatly and a few of the Zuiver Displays even offer space to store stock. Self-service it is! In addition to all of this, the Zuiver Display Houses look amazing: The styling has been done for you in advance by art director Caroline!





LIGHTING DISPLAY NEW

Dimensions: 160x80x240 (WxDxH)
 Note: without content; flat packed

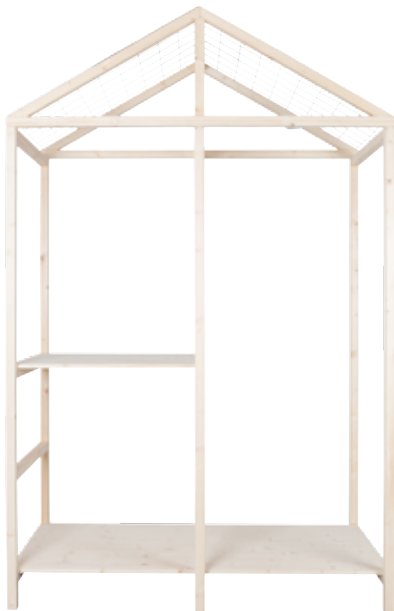

TIP

"Having a hard time to choose from our huge collection? Pick one of my favourite combinations"

ZUIVER-CODE	GTIN-CODE	ITEM NAME		
9900021	8718548031449	DISPLAY CABINET LIGHTING		
PACKING	1 PCS			
QTY	CTN SIZE (CM)	CBM	NW (KG)	GW (KG)
1	200x22x80	0,352	46,8	46,8



TEXTILE DISPLAY NEW

Dimensions: 120x80x190 (WxDxH)
Note: without content; assembled



ZUIVER-CODE	GTIN-CODE	ITEM NAME		
9900022	8718548031456	DISPLAY CABINET TEXTILE		
PACKING	1 PCS			
QTY	CTN SIZE (CM)	CBM	NW (KG)	GW (KG)
1	80x120x190	1,824	63,3	63,3

ART DIRECTOR'S CHOICE TIP

"Having a hard time to choose from our huge collection? Pick one of my favourite combinations"





SIDE TABLE DISPLAY NEW

Dimensions: 3x 120x80x60 (WxDxH)

Note: without content; assembled stacked packing

**ART DIRECTOR'S
CHOICE** TIP

“Having a hard time to choose from our huge collection? Pick one of my favourite combinations”



ZUIVER-CODE	GTIN-CODE	ITEM NAME		
9900023	8718548031463	DISPLAY CABINET SIDE TABLE		
PACKING	1 PCS			
QTY	CTN SIZE (CM)	CBM	NW (KG)	GW (KG)
1	120x80x150	1,44	74,2	74,2



CLOCK DISPLAY NEW

Dimensions: 120x80x190 (WxDxH)
 Note: without content; assembled



**ART DIRECTOR'S
 CHOICE** TIP

“Having a hard time to choose from our huge collection? Pick one of my favourite combinations!”



ZUIVER-CODE	GTIN-CODE	ITEM NAME		
9900024	8718548031470	DISPLAY CABINET CLOCK		
PACKING	1 PCS			
QTY	CTN SIZE (CM)	CBM	NW (KG)	GW (KG)
1	80x120x190	1,824	41	41



SPOTLIGHT DISPLAY

Here is a way to set our Zuiver Spotlights in the.... well... SPOTLIGHT! We designed this super versatile Spotlight Display to hold your Zuiver spotlight stock and display them, at the same time. Just plug it in a socket and let the Zuiver spotlights simply shine and thus sell themselves...!

Ready for use display cabinet on wheels
 Dimensions: 120x51,5x214,5 (WxDxH)
 Here's a list of what's in it:

Code	Component	Number
	DISPLAY CABINET ZUIVER	1
5500608	SPOT LIGHT LUCI-1 LED WHITE	5
5500609	SPOT LIGHT LUCI-1 LED BLACK	4
5500607	SPOT LIGHT LUCI-1 LED ALU	4
5500611	SPOT LIGHT LUCI-2 LED WHITE	4
5500612	SPOT LIGHT LUCI-2 LED BLACK	4
5500610	SPOT LIGHT LUCI-2 LED ALU	4
5500010	SPOT LIGHT DICE-1 LED COPPER	4
5500011	SPOT LIGHT DICE-2 LED COPPER	4
5500012	SPOT LIGHT DICE-1 LED GALVANISED	4
5500013	SPOT LIGHT DICE-2 LED GALVANISED	4
5500008	SPOT LIGHT DICE-1 LED WHITE	5
5500009	SPOT LIGHT DICE-2 LED WHITE	4

ZUIVER-CODE	GTIN-CODE	ITEM NAME
5900001	8718548023581	SPOT LIGHT DISPLAY



LED-DISPLAY

Build-a-lamp with BULB series by Zuiver

Who wouldn't want to be a light fixture designer? We at Zuiver want to give you that opportunity without the need for a career change. It's fairly simple, so go and build-a-lamp with Zuiver.

1. Decide on your fixture: Pendant or table.
2. Pick a material for your fixture.
3. And now for the finishing touch, choose your über cool bulb.

That is it, you designed your own light fixture!

Ready for use display cabinet on wheels

Dimensions: 120x61,5x219 (WxDxH)

Here's a list of what's in it:

Code	Component	Number
9900020	DISPLAY CABINET ZUIVER 2	1
5600001	BULB CLASSIC LED	24
5600002	BULB DROP LED	12
5600003	BULB TUBE LED	12
5600004	BULB MIRROR LED	12
5600005	BULB GLOBE LED	18
5200021	TABLE LAMP BOLCH COPPER	6
5200022	TABLE LAMP BOLCH CONCRETE	6
5200023	TABLE LAMP BOLCH MARBLE BLACK	6
5200024	TABLE LAMP BOLCH MARBLE WHITE	6
5300086	PENDANT LAMP MACH COPPER	6
5300087	PENDANT LAMP MACH CONCRETE	6
5300088	PENDANT LAMP TRUST MARBLE BLACK	6
5300089	PENDANT LAMP TRUST MARBLE WHITE	6

ZUIVER-CODE	GTIN-CODE	ITEM NAME
5900002	8718548027701	LED LIGHT DISPLAY





WELCOME TO ZUIVER



**WHY TO
CHOOSE
ZUIVER?**



TRENDS

Zuiver is always on the lookout for the latest trends in interior design. These spotted trends inspire us to develop new products for Zuiver, giving them our own Zuiver twist. Never a dull collection, and always on the move for the next upcoming materials, techniques and designs. Over and over again.

SHOP IN SHOP

The Zuiver shop concept is a great opportunity for our retailers. This ready made Zuiver shop, in a typical Zuiver style, allows you to show the complete Zuiver collection. A collection which is constantly up to date and mostly on stock. And above all the Zuiver shop is a great way to boost your turn over.

PROJECT

Commercial partners of Zuiver, such as architects, stylists and contract partners, decorate many schools, hotels, restaurants and offices with our cool products. The Zuiver collection is highly suitable for decorating these sort of projects! So if you would like to spice up a work area you know where to find us!

STOCK

Zuiver keeps most items in stock for you, so we can deliver them a.s.a.p. after you placed an order. In our warehouse containers with products from all over the world are unloaded and stored. From here all the products are transported to our customers world wide.

PRICE

Zuiver thinks it is important to introduce affordable products, without compromising on quality. One way of doing this is by flat packing the products as much as possible. This way we are able to keep the transport costs low, which makes it possible to offer you the best price.



ENERGY LABELS

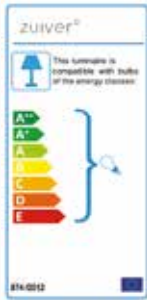

Energylabel 1



Energylabel 2



Energylabel 3

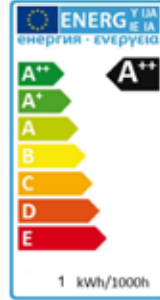

Energylabel 4

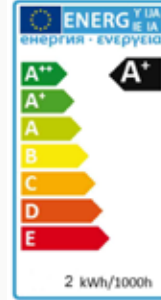

Energylabel 5



Energylabel 6

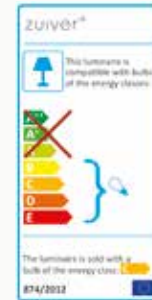

Energylabel 7

© Zuiver 2017

All rights reserved. No part of this publication may be reproduced by any means without prior permission in writing from Zuiver BV. Zuiver is a registered trademark.

Disclaimer:

Whilst all care has been made in the compilation of this magazine, the company can not accept responsibility for any errors or changes to the contents.

Please note that due to the printing process all colours, as seen in this brochure, may slightly vary from the actual colours.

General terms & conditions: www.zuiver.com

COLOPHON

Art Director:
Caroline van Velze
Graphic design:
Liz de Rover
Carla Verhagen
Styling & photography:
Nienke Fris
Robbert Frie
Text:
Eveliëne van Zanten

Special thanks to Monsieur Artiste for
lending us a few of their pieces of art
monsieurartiste.nl



OFFICE & SHOWROOM

Rak 20
1551 NA Westzaan
Holland

POSTAL ADDRESS

P.O. box 69
1500 EB Zaandam
Holland

PHONE: +31(0)75 6146020

MAIL: info@zuiver.com

WEBSITE: www.zuiver.com

FOLLOW US ON

