

# 15" Capacitive Touch Monitor



- Patented IP65 Front with silicon seal
- Strengthened cover glass
- Anti glare treatment (chemical etching)
- 10-finger-multi touch capacitive touch
- LED backlight backed Panels in A+ quality
- Screwable connection for rugged environments



faytech's capacitive Touchscreen Monitor series has a modern sleek look with its flat edge to edge glass front panels, and a patented silicone rubberized seal making the front panels IP65 water proof and dust proof.

This new series comes with capacitive 10 finger multi touch, glass front following MosH7, the glass surface is anti glare treated (chemical etched), a wide variety of interfaces including USB-B for touch, HDMI, DVI-D, VGA and Audio inputs, all lockable including the DC-IN. Each capacitive Touch Monitor has an A+ industrial LCD panel backed by faytech's 100% no dead pixel guarantee. Each monitor comes with its own desktop stand, and screw patterns on the back for VESA-100 mounts.

The high resolution support (e.g. 768p, 1920x1200 pixels) of these faytech touchscreens make them the perfect choice for a wide variety of applications including use in POS systems, as control panels in the industrial area, in kiosk systems, for machine control, in the office and in many other areas.

The integrated 10 finger capacitive multi touch panel is robust and accurate. The touch function is quickly established via the USB port of your PC. faytech includes touchscreen drivers for popular Microsoft (CE, WinXP, Vista, Win 7, Win 8, Win 10), Mac, Android and Linux operating systems. For Win 7, Win 8 and Win 10 operating systems no driver installation is needed. Login using virtual keyboard and immediate use of windows gestures making starting and using Windows incredibly easy. Embedded systems like e.g. the raspberry Pi are also supported.

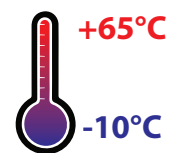

<b>Product name</b>	<b>15" Capacitive Touch Monitor</b>
<b>Article code / EAN numer</b>	<b>FT15TMBCAP / 6920734015146</b>

Anti-glare LCD Panel	
IP rated front panel	IP65
Screen diagonal (Inch/cm):	15/38.10
Display active screen size:	30.40×22.80
Aspect ratio:	4:3
Physical resolution:	1024×768
Maximum showable resolution (TPCs: external):	1920×1200
Colours displayed:	16.2M
Brightness (cd/m2):	300
Contrast:	700:1
Typical reaction time Tr/ Tf (ms):	8/8
Visual Angle horizontal/vertical (°):	160/160
Backlight / Backlight Lifetime (hours):	LED / 40,000

External Connectors	
Video	1x VGA
	1x DVI-D
	1x HDMI 1.1 (incl. HDCP)
Audio	1x PC-Audio
	1x Earphone-Out
Touch Connector	1x USB
Connectors	1x 12V DC-IN

Touch Panel	
Touch Technology	Projected Capacitive 10-point Multitouch
Touch Connector	USB
Touch Panel Drivers	Windows; Linux; Mac; Android
Touch Life (Contacts)	Unlimited
Surface Hardness	7H

Operation / Mechanical	
Operating Temperature (°C)	-10 ~ +65
Humidity Range (RH)	10%-90%
Net weight (kg)	4.10
Gross weight (kg)	5.10 (incl. cartonage)
Housing material	Plastic
Housing (cm) LxWxH	35.20 x 27.60 x 6.20
Mounting	VESA 100

Power	
Power Indicator	Green LED
Power Supply	100-240V ACDC active switching; 12V DC-Out
Working Power (V)	12
Power Consumption (W)	18
Stand-By Consumption (W)	<1

Included in the Delivery	
Power Supply (see Power section)	
Driver DVD	
Short Installation Manual	
Cables - VGA, USB Touch	
Standard Stand	

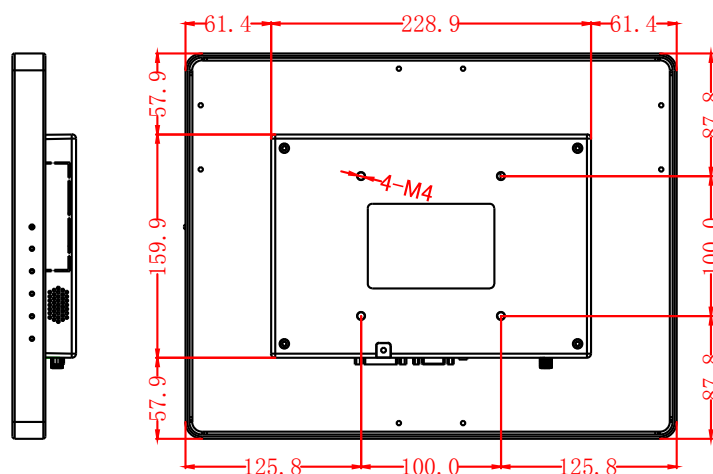
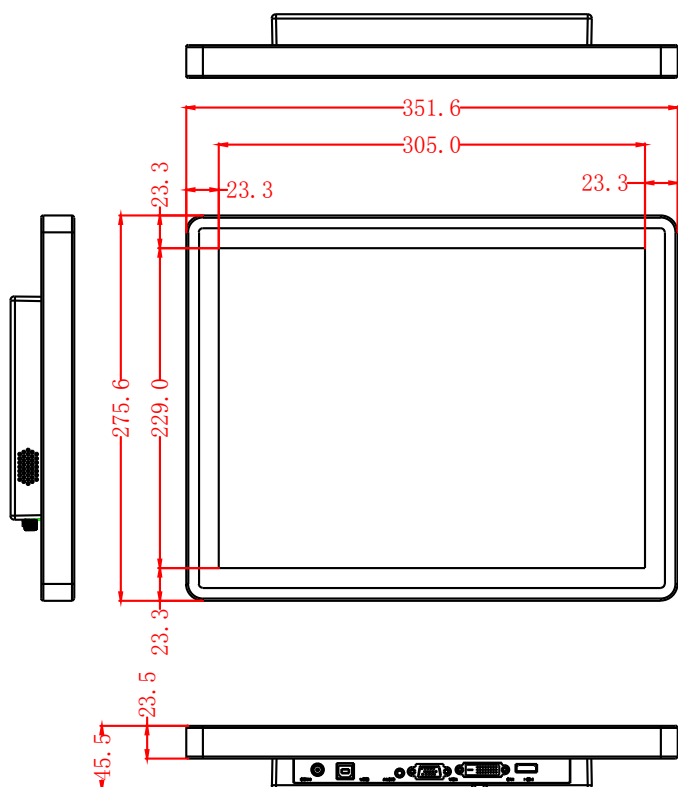

## Corporate Headquarters

**faytech Tech. Co., Ltd.**  
 Building C., Hongmen Tech. Zone,  
 Jihua Rd., Shenzhen, China 518129

[support@faytech.com](mailto:support@faytech.com)  
[contact@faytech.com](mailto:contact@faytech.com)  
[www.faytech.com](http://www.faytech.com)

China: +86 755 89580612  
 Germany: +49 551 82098660  
 USA: +1 646 205 3214