

A

DIMA - TEMPLATE



R 30 mm
1.18"



R 30 mm
1.18"

PORTE DI VETRO
GLASS DOORS
PORTES VITREES
GLASTÜREN
GLAZEN DEUREN
PUERTAS DE VIDRIO

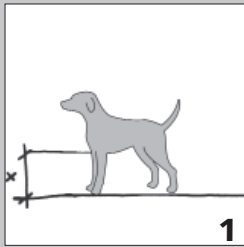
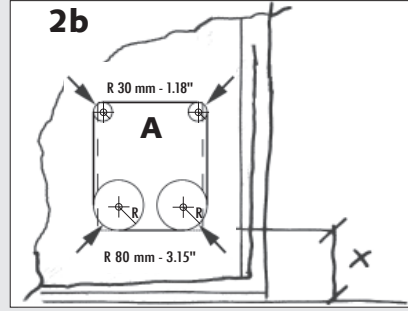
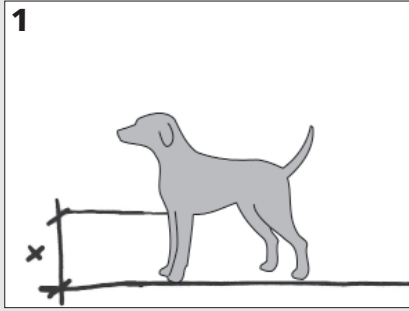

1

PORTE DI LEGNO, DI METALLO,
PARETI E ZANZARIERE
WOODEN, METAL DOORS,
WALLS AND SCREENS
PORTES EN BOIS, EN METAL,
MURS ET MOUSTIQUAIRES
HOLZ, METALL TÜREN,
WÄNDE ODER MÜCKENNETZE
HOUTEN EN METALEN DEUREN,
TUSSENWANDEN EN VLEGGENGAAS
PUERTAS DE MADERA, DE METAL,
PAREDES, MOSQUITERAS

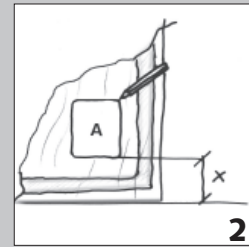

2

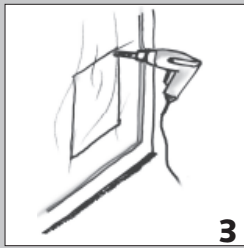

3

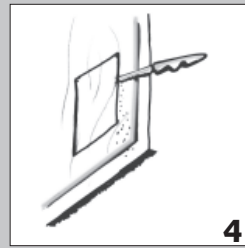

4

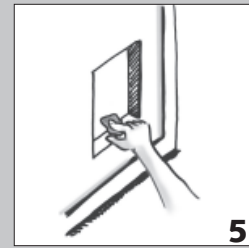

5



R 80 mm
3.15"



R 80 mm
3.15"

FERITOIA n°1 PER SPESSORI Y=5÷10mm
 SLIT n°1 - THICKNESS Y=5÷10mm
 FENTE n°1 - EPAISSEUR Y=5÷10mm

SCHLITZ n°1-STÄRKEDURCHMESSER Y=5÷10mm
 OPENING WAARIN n°1 - DIKTE Y=5÷10mm
 RANURA n°1 - ESPESOR Y=5÷10mm

B

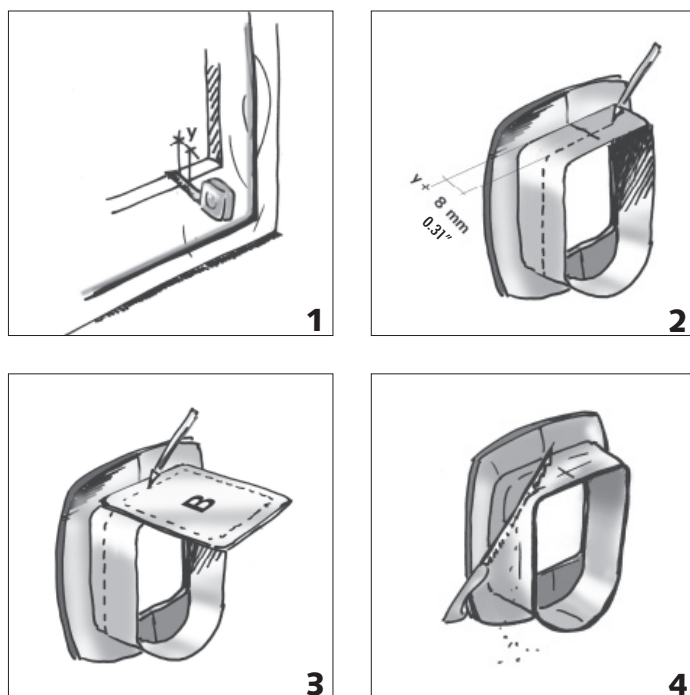

N	Y	Y inch
1	5-10 mm	0.20"-0.39"
2	15-20 mm	0.59"-0.79"
3	25-30 mm	0.98"-1.18"
4	35-40 mm-	1.38"-1.57"

FERITOIA n°3 PER SPESSORI Y=25÷30mm
 SLIT n°3 - THICKNESS Y=25÷30mm
 FENTE n°3 - EPAISSEUR Y=25÷30mm
 SCHLITZ n°3 - STÄRKEDURCHMESSER Y=25÷30mm
 OPENING WAARIN n°3 - DIKTE Y=25÷30mm
 RANURA n°3 - ESPESOR Y=25÷30mm

FERITOIA n°4 PER SPESSORI Y=35÷40mm
 SLIT n°4 - THICKNESS Y=35÷40mm
 FENTE n°4 - EPAISSEUR Y=35÷40mm
 SCHLITZ n°4 - STÄRKEDURCHMESSER Y=35÷40mm
 OPENING WAARIN n°4 - DIKTE Y=35÷40mm
 RANURA n°4 - ESPESOR Y=35÷40mm

FERITOIA n°2 PER SPESSORI Y=15÷20mm
 SLIT n°2 - THICKNESS Y=15÷20mm
 FENTE n°2 - EPAISSEUR Y=15÷20mm
 SCHLITZ n°2 - STÄRKEDURCHMESSER Y=15÷20mm
 OPENING WAARIN n°2 - DIKTE Y=15÷20mm
 RANURA n°2 - ESPESOR Y=15÷20mm