



NOVEDADES

ews
ouveautés



Estante mural inclinado para cestas de lavavajillas Sloping inclined wall rack shelf Étagère murale inclinée pour paniers de lavage	35
Taburete con ruedas Rolling step-stool Tabouret marche - pied roulant	35



ESTANTERÍAS Y ESTANTES
Shelving and shelves
Rayonnages et étagères



Optimice su espacio con esta nueva estación de trabajo

imagine GN es una nueva herramienta pensada para optimizar el espacio de trabajo. Este innovador sistema emplea un diseño Cantilever que elimina los soportes frontales, incrementando hasta un 40% más el espacio útil de trabajo dentro de la misma zona.

Se instala con facilidad y rapidez. Basado en las dimensiones internacionales GASTRONORM, está fabricado totalmente en acero inoxidable, con un diseño moderno y único.

imagine GN lo podrá utilizar para almacenamiento tanto en lugares secos como en ambientes con humedad, cocinas industriales, salas de preparación y elaboración de alimentos, laboratorios, clínicas, talleres, estaciones de servicio, etc.

Con las soluciones modulares imagine GN puede configurar fácil y rápidamente su espacio de trabajo atendiendo a las necesidades de cambio.



Puede regular la altura (cada 140 mm.) y la inclinación de los estantes sin usar herramientas. Shelves height (every 140 mm.) and lean can be adjusted without using any tool. Vous pouvez régler l' hauteur (tous 140 mm.) et l' inclination des étagères sans utiliser des outils.

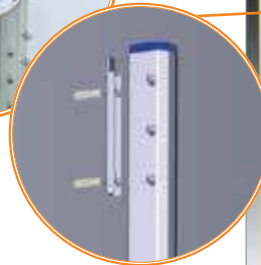

imagine GN Optimize your space with this innovative work station.

imagine GN is a new tool, thought to optimize your work room. This innovative system employs a Cantilever design that eliminates the front supports, increasing up to a 40% the useful surface within the work area.

You can mount it easily and quickly. Based in the international dimensions GASTRONORM, it is made totally in stainless steel, with a modern and unique design.

imagine GN can be used to stock in dry areas as well as in places with wet atmosphere, industrial kitchens, food preparation rooms, laboratories, clinics, garages, petrol stations, etc.

With the imagine GN modular solutions you can easily and quickly design your working area meeting at the same time your needs of change.

Now with imagine GN you will be able to re-design your work area whenever it is necessary.

LAS NECESIDADES CAMBIAN

Needs change
Les besoins changent



Detalle de fijación a pared.
Wall fixing detail.
Détails de fixation murale.

Ahora con imagine GN podrá rediseñar su espacio de trabajo cuando sea necesario.

imagine GN Optimisez votre espace avec cette nouvelle station de travail.

imagine GN, c'est un nouveau outil conçu pour optimiser l'espace de travail. Cette innovateur système emploie un dessin Cantilever qu'évite des supports frontaux, et c'est ainsi qu'on augmente la surface utile dans le zone de travail.

On l'installe facilement et rapidement. Dessinée sur les dimensions internationales Gastronorm, elle est fabriquée totalement en acier inoxydable avec une finition moderne et unique.

imagine GN, vous pouvez l'utiliser pour le stockage tandis dans endroits secs comme dans endroits avec atmosphère humide, cuisines industrielles, salles de préparation des aliments, laboratoires, cliniques, ateliers, stations-service, etc.

Avec les solutions modulaires imagine GN vous pouvez configurer facile et rapidement votre espace de travail en tenant en compte au même temps votre besoins d'échange.



Maintenant avec imagine GN vous pourrez re-dessiner votre espace quand il soit nécessaire.

Dimensiones Dimensions mm		Composición Set Set	1/1 A = 413 mm Número de estantes Number of shelves Número d'étagères			2/1 A = 614 mm Número de estantes Number of shelves Número d'étagères			
L	H		€	€	€	Composición Set Set	€	€	€
764	1.700	1A				1D			
1.174	1.700	1B				1E			
1.414	1.700	1C				1F			
1.475	1.700	1A+1a				1D+1d			
1.885	1.700	1A+1b				1D+1e			
2.125	1.700	1A+1c				1D+1f			
2.186	1.700	1A+2a				1D+2d			
2.295	1.700	1B+1b				1E+1e			
2.535	1.700	1B+1c				1E+1f			
2.596	1.700	1B+2a				1E+2d			
2.775	1.700	1C+1c				1F+1f			
2.836	1.700	1C+2a				1F+2d			
2.897	1.700	1A+3a				1D+3d			
3.006	1.700	1A+2b				1D+2e			
3.246	1.700	1A+1b+1c				1D+1e+1f			
3.307	1.700	1B+3a				1E+3d			
3.416	1.700	1B+2b				1E+2e			
3.486	1.700	1A+2c				1D+2f			
3.547	1.700	1C+3a				1F+3d			
3.608	1.700	1A+4a				1D+4d			
3.656	1.700	1C+2b				1F+2e			
3.717	1.700	1A+1a+2b				1D+1d+2e			
3.896	1.700	1B+2c				1E+2f			
3.957	1.700	1B+2a+1c				1E+2d+1f			
4.018	1.700	1B+4a				1E+4d			
4.127	1.700	1A+3b				1D+3e			
4.136	1.700	1C+2c				1F+2f			
4.197	1.700	1A+1a+2c				1D+1d+2f			
4.258	1.700	1C+4a				1F+4d			
4.319	1.700	1A+5a				1D+5d			
4.367	1.700	1A+2b+1c				1D+2e+1f			
4.428	1.700	1A+2a+2b				1D+2d+2e			
4.537	1.700	1B+3b				1E+3e			
4.607	1.700	1A+1B+2c				1D+1E+2f			
4.668	1.700	1B+3a+1c				1E+3d+1f			
4.729	1.700	1B+5a				1E+5d			
4.777	1.700	1C+3b				1F+3e			
4.838	1.700	1A+1a+3b				1D+1d+3e			
4.847	1.700	1A+3c				1D+3f			
4.908	1.700	1A+2a+2c				1D+2d+2f			
4.969	1.700	1C+5a				1F+5d			
5.017	1.700	1B+1b+2c				1E+1e+2f			
5.030	1.700	1A+6a				1D+6d			
5.078	1.700	1C+2a+2b				1F+2d+2e			
5.139	1.700	1A+3a+2b				1D+3d+2e			
5.248	1.700	1A+4b				1D+4e			
5.257	1.700	1B+3c				1E+3f			
5.318	1.700	1B+2a+2c				1E+2d+2f			

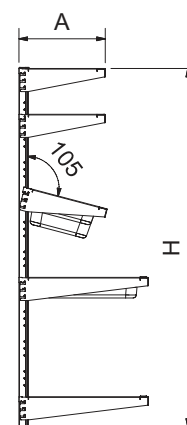
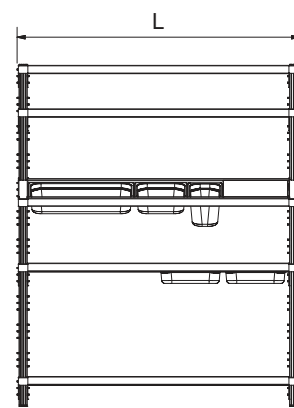

A, B, C, D, E, F

Las composiciones básicas imagine cuentan con todos los elementos necesarios para su montaje individual.

They are basic structures of the wall-side system imagine GN, and they are fully equipped for their individual assembly.

Elles sont structures basiques du système mural imagine, et sont pourvues avec tous les éléments nécessaires pour son montage individuel.

a, b, c, d, e, f

Cuentan con los elementos necesarios para prolongar las composiciones básicas imagine. Se deben pedir únicamente con ese fin, pues no podrían montarse por sí mismas al faltarles pies, soportes, cartelas, etc.

They are the necessary elements to extend the basic structures imagine. They are complementary and can only be installed together with the basic structures.

Ils sont des éléments nécessaires pour prolonger les structures basiques imagine. Ils sont complémentaires et seulement peuvent être installés conjointement avec ces structures basiques.

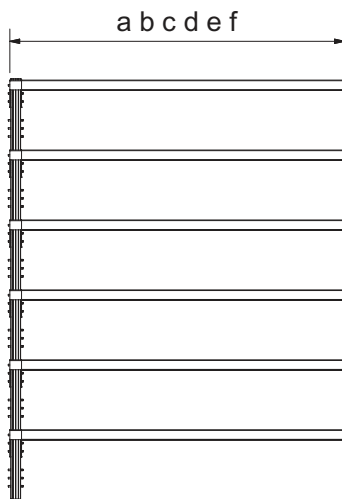
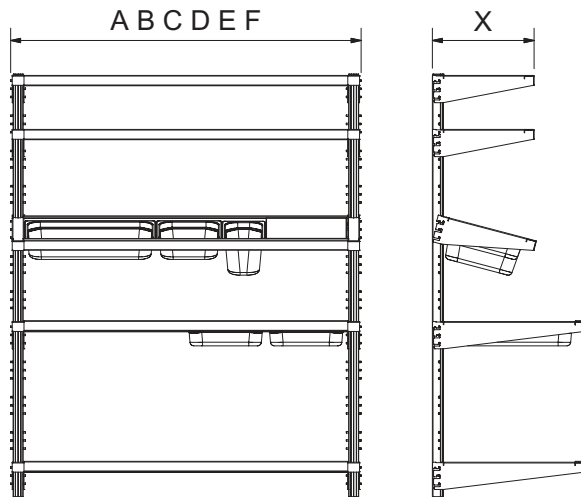

Prolongación de composiciones básicas
 Extended basic structures
 Structures basiques prolongées

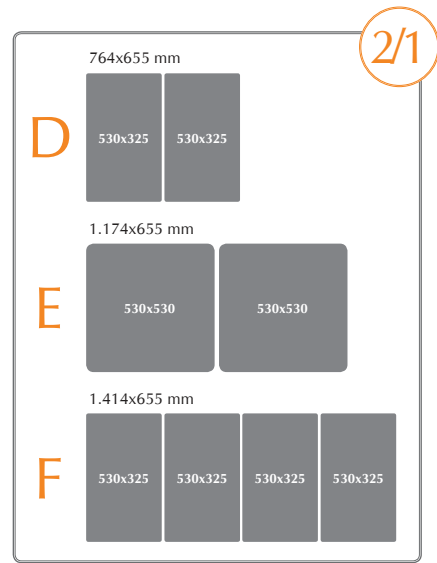
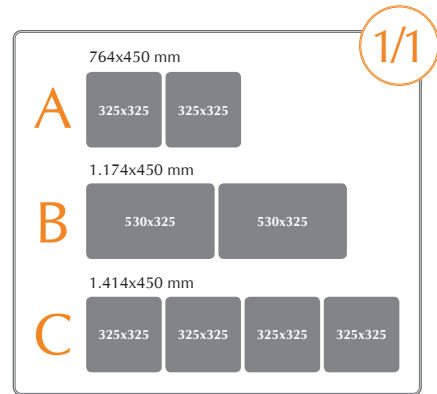

		Número de estantes Number of shelves Numéro d'étagères			
		3	4	5	
		← X →	€	€	€
A	764	413			
a	711	413			
B	1.174	413			
b	1.121	413			
C	1.414	413			
c	1.361	413			
D	764	614			
d	711	614			
E	1.174	614			
e	1.121	614			
F	1.414	614			
f	1.361	614			

Dimensiones Dimensions Dimensions		1/1 A = 451 mm Número de estantes Number of shelves Número d'étagères			2/1 A = 656 mm Número de estantes Number of shelves Número d'étagères				
mm		Composición Set Set	3	4	5	Composición Set Set	3	4	5
L	H		€	€	€		€	€	€
764	1.700	1A				1D			
1.174	1.700	1B				1E			
1.414	1.700	1C				1F			
1.475	1.700	1A+1a				1D+1d			
1.885	1.700	1A+1b				1D+1e			
2.125	1.700	1A+1c				1D+1f			
2.186	1.700	1A+2a				1D+2d			
2.295	1.700	1B+1b				1E+1e			
2.535	1.700	1B+1c				1E+1f			
2.596	1.700	1B+2a				1E+2d			
2.775	1.700	1C+1c				1F+1f			
2.836	1.700	1C+2a				1F+2d			
2.897	1.700	1A+3a				1D+3d			
3.006	1.700	1A+2b				1D+2e			
3.246	1.700	1A+1b+1c				1D+1e+1f			
3.307	1.700	1B+3a				1E+3d			
3.416	1.700	1B+2b				1E+2e			
3.486	1.700	1A+2c				1D+2f			
3.547	1.700	1C+3a				1F+3d			
3.608	1.700	1A+4a				1D+4d			
3.656	1.700	1C+2b				1F+2e			
3.717	1.700	1A+1a+2b				1D+1d+2e			
3.896	1.700	1B+2c				1E+2f			
3.957	1.700	1B+2a+1c				1E+2d+1f			
4.018	1.700	1B+4a				1E+4d			
4.127	1.700	1A+3b				1D+3e			
4.136	1.700	1C+2c				1F+2f			
4.197	1.700	1A+1a+2c				1D+1d+2f			
4.258	1.700	1C+4a				1F+4d			
4.319	1.700	1A+5a				1D+5d			
4.367	1.700	1A+2b+1c				1D+2e+1f			
4.428	1.700	1A+2a+2b				1D+2d+2e			
4.537	1.700	1B+3b				1E+3e			
4.607	1.700	1A+1B+2c				1D+1E+2f			
4.668	1.700	1B+3a+1c				1E+3d+1f			
4.729	1.700	1B+5a				1E+5d			
4.777	1.700	1C+3b				1F+3e			
4.838	1.700	1A+1a+3b				1D+1d+3e			
4.847	1.700	1A+3c				1D+3f			
4.908	1.700	1A+2a+2c				1D+2d+2f			
4.969	1.700	1C+5a				1F+5d			
5.017	1.700	1B+1b+2c				1E+1e+2f			
5.030	1.700	1A+6a				1D+6d			
5.078	1.700	1C+2a+2b				1F+2d+2e			
5.139	1.700	1A+3a+2b				1D+3d+2e			
5.248	1.700	1A+4b				1D+4e			
5.257	1.700	1B+3c				1E+3f			
5.318	1.700	1B+2a+2c				1E+2d+2f			

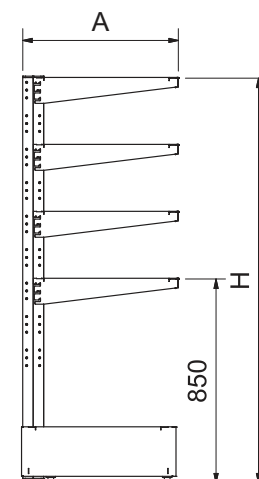
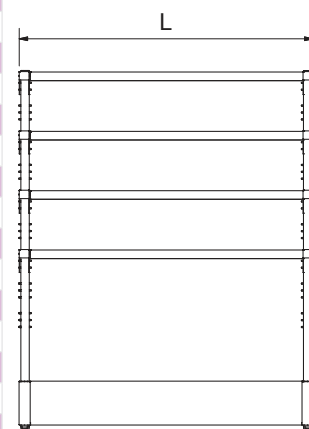

Cuadro comparativo de estanterías imagine central

Comparative chart of center imagine units

Tableau comparatif d'étagères imagine centrales

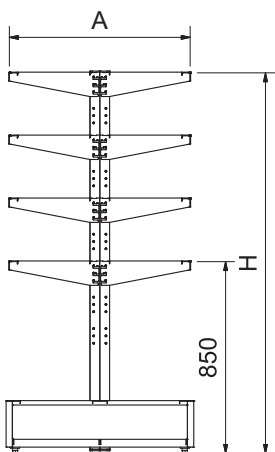
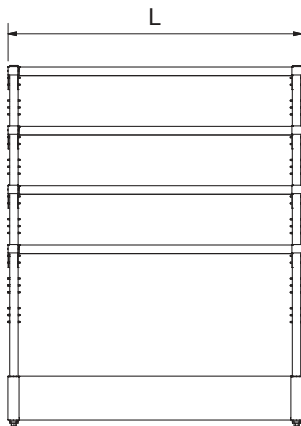

Dimensiones Dimensions Dimensions		Composición Set Set	1/1 A = 850 mm Número de estantes Number of shelves Numéro d'étagères			2/1 A = 1.255 mm Número de estantes Number of shelves Numéro d'étagères		
mm	mm		3	4	5	3	4	5
L	H		€	€	€	€	€	€
764	1.700	1L				1P		
1.174	1.700	1M				1Q		
1.414	1.700	1N				1R		
1.475	1.700	1L+1l				1P+1p		
1.885	1.700	1L+1m				1P+1q		
2.125	1.700	1L+1n				1P+1r		
2.186	1.700	1L+2l				1P+2p		
2.295	1.700	1M+1m				1Q+1q		
2.535	1.700	1M+1n				1Q+1r		
2.596	1.700	1M+2l				1Q+2p		
2.775	1.700	1N+1n				1R+1r		
2.836	1.700	1N+2l				1R+2p		
2.897	1.700	1L+3l				1P+3p		
3.006	1.700	1L+2m				1P+2q		
3.246	1.700	1L+1m+1n				1P+1q+1r		
3.307	1.700	1M+3l				1Q+3p		
3.416	1.700	1M+2m				1Q+2q		
3.486	1.700	1L+2n				1P+2r		
3.547	1.700	1N+3l				1R+3p		
3.608	1.700	1L+4l				1P+4p		
3.656	1.700	1N+2m				1R+2q		
3.717	1.700	1L+1l+2m				1P+1p+2q		
3.896	1.700	1M+2n				1Q+2r		
3.957	1.700	1M+2l+1n				1Q+2p+1r		
4.018	1.700	1M+4l				1Q+4p		
4.127	1.700	1L+3m				1P+3q		
4.136	1.700	1N+2n				1R+2r		
4.197	1.700	1L+1l+2n				1P+1p+2r		
4.258	1.700	1N+4l				1R+4p		
4.319	1.700	1L+5l				1P+5p		
4.367	1.700	1L+2m+1n				1P+2q+1r		
4.428	1.700	1L+2l+2m				1P+2p+2q		
4.537	1.700	1M+3m				1Q+3q		
4.607	1.700	1L+1M+2n				1P+1Q+2r		
4.668	1.700	1M+3l+1n				1Q+3p+1r		
4.729	1.700	1M+5l				1Q+5p		
4.777	1.700	1N+3m				1R+3q		
4.838	1.700	1L+1l+3m				1P+1p+3q		
4.847	1.700	1L+3n				1P+3r		
4.908	1.700	1L+2l+2n				1P+2p+2r		
4.969	1.700	1N+5l				1R+5p		
5.017	1.700	1M+1m+2n				1Q+1q+2r		
5.030	1.700	1L+6l				1P+6p		
5.078	1.700	1N+2l+2m				1R+2p+2q		
5.139	1.700	1L+3l+2m				1P+3p+2q		
5.248	1.700	1L+4m				1P+4q		
5.257	1.700	1M+3n				1Q+3r		
5.318	1.700	1M+2l+2n				1Q+2p+2r		

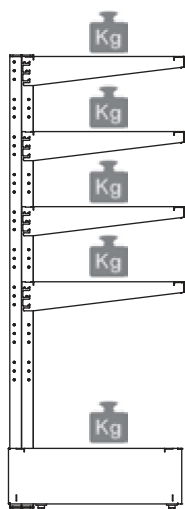
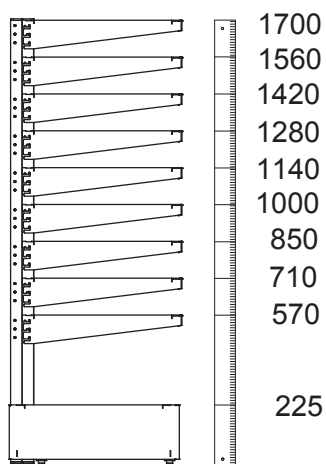
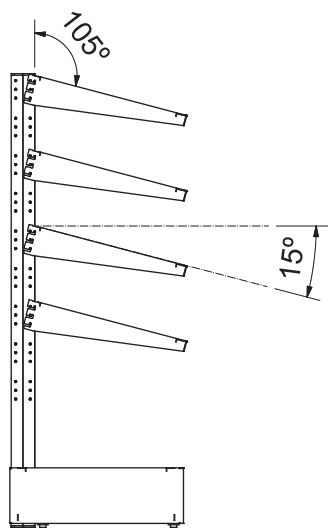

Capacidad de estantes:

Sistema mural 10 niveles por módulo.
 Sistema central 10 niveles dobles por módulo.

Shelving unit capacity:

Wall-side system – 10 levels per unit.
 Centre system – 10 double levels per unit.

Capacité des étagères:

Système mural – 10 niveaux par module.
 Système central – 10 niveaux doubles par module.

Kg = 125 Kg.

Las cargas se consideran uniformemente repartidas en la superficie del estante.
 It is assumed that loads are evenly distributed on the shelf surface.
 On considère que les charges sont réparties uniformément sur la surface de l'étagère.

A, B, C, D, E, F

Las composiciones básicas imagine cuentan con todos los elementos necesarios para su montaje individual.

They are basic structures of the wall-side system imagine GN, and they are fully equipped for their individual assembly.

Elles sont structures basiques du système mural imagine, et sont pourvues avec tous les éléments nécessaires pour son montage individuel.

a, b, c, d, e, f

Cuentan con los elementos necesarios para prolongar las composiciones básicas imagine. Se deben pedir únicamente con ese fin, pues no podrían montarse por sí mismas al faltarles pies, soportes, cartelas, etc.

They are the necessary elements to extend the basic structures imagine. They are complementary and can only be installed together with the basic structures.

Ils sont des éléments nécessaires pour prolonger les structures basiques imagine. Ils sont complémentaires et seulement peuvent être installés conjointement avec ces structures basiques.

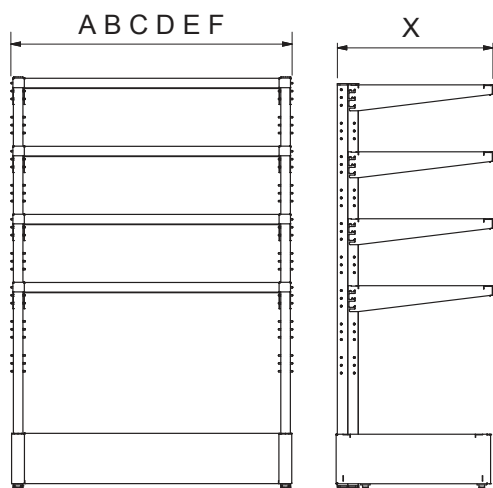

Composiciones básicas
 Basic structures
 Structures basiques

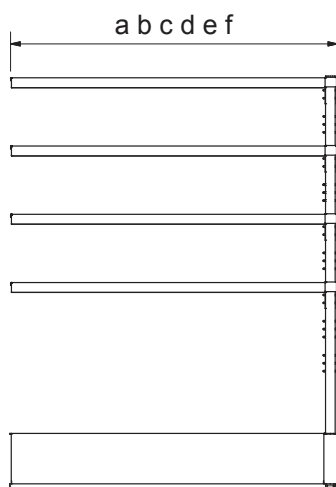

Prolongación de composiciones básicas
 Extended basic structures
 Structures basiques prolongées

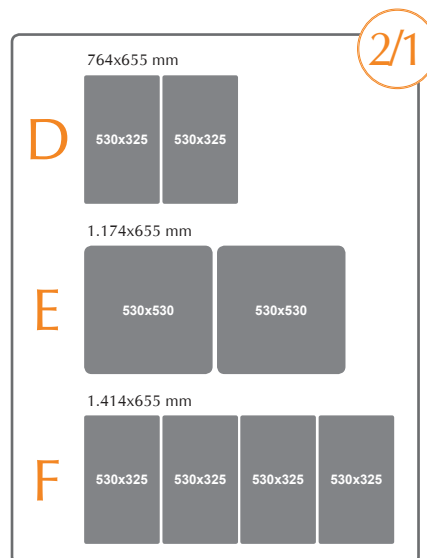
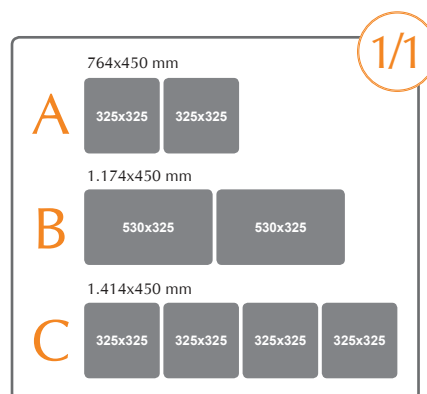

		Número de estantes Number of shelves Numéro d'étagères			
		3	4	5	
		← X →	€	€	€
A	764	450			
a	711	450			
B	1.174	450			
b	1.121	450			
C	1.414	450			
c	1.361	450			
D	764	655			
d	711	655			
E	1.174	655			
e	1.121	655			
F	1.414	655			
f	1.361	655			

L, M, N, P, Q, R

Las composiciones básicas imagine cuentan con todos los elementos necesarios para su montaje individual.

They are basic structures of the wall-side system imagine, and they are fully equipped for their individual assembly.

Elles sont structures basiques du système mural imagine, et sont pourvues de tous les éléments nécessaires pour son montage individuel.

l, m, n, p, q, r

Cuentan con los elementos necesarios para prolongar las composiciones básicas imagine. Se deben pedir únicamente con ese fin, pues no podrían montarse por sí mismas al faltarles pies, soportes, cartelas, etc.

They are the necessary elements to extend the basic structures imagine GN. They are complementary and can only be installed together with the basic structures.

Ils sont des éléments nécessaires pour prolonger les structures basiques imagine GN. Ils sont complémentaires et seulement peuvent être installés conjointement avec ces structures basiques.

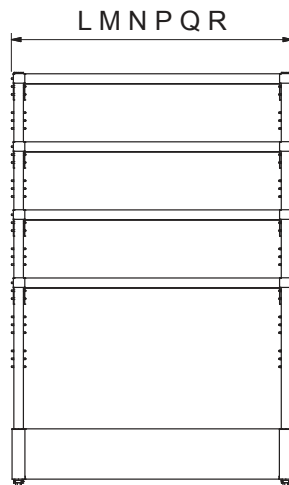
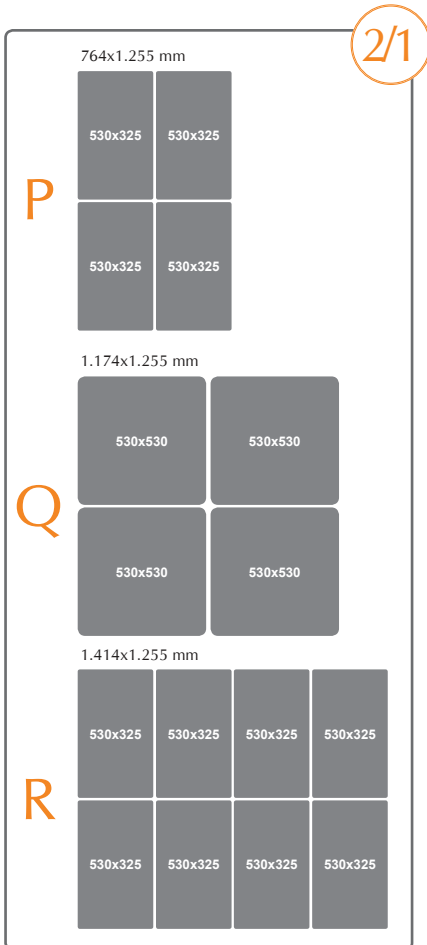
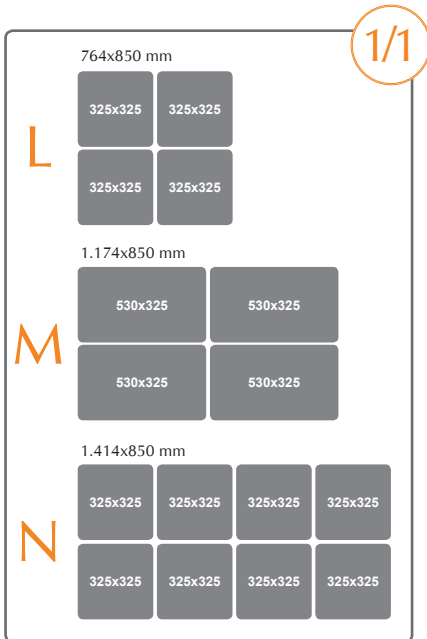

Composiciones básicas
 Basic structures
 Structures basiques

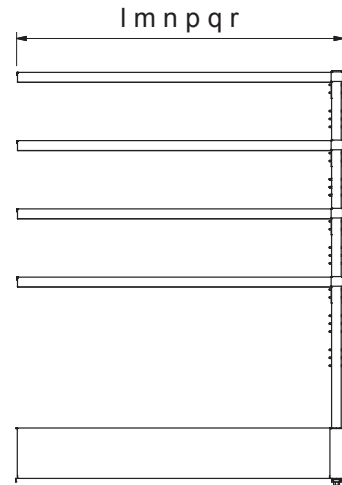

Prolongación de composiciones básicas
 Extended basic structures
 Structures basiques prolongées

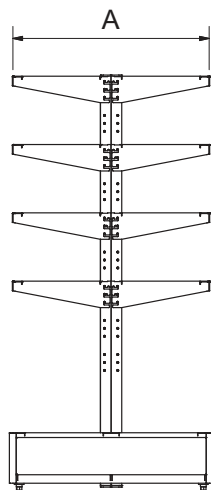

		Número de estantes Number of shelves Numéro d'étagères		
		3	4	5
		← A →	€	€
L	764 850			
l	711 850			
M	1.174 850			
m	1.121 850			
N	1.414 850			
n	1.361 850			
P	764 1.255			
p	711 1.255			
Q	1.174 1.255			
q	1.121 1.255			
R	1.414 1.255			
r	1.361 1.255			

Pies murales imagine
Wall-side legs imagine
Pieds muraux imagine

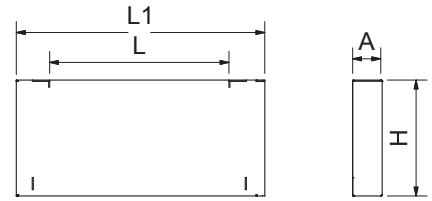

Dimensiones Dimensions Dimensions						
L	A	H	L1	Kg	Barcode	€
325	53	210	450	3,50	013806	
530	53	210	655	5,25	013808	

Pies centrales imagine
Centre legs imagine
Pieds centraux imagine

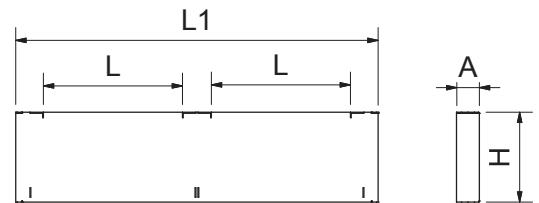

Dimensiones Dimensions Dimensions						
L	A	H	L1	Kg	Barcode	€
325	53	210	850	6,2	013802	
530	53	210	1.260	9,2	013804	

Largueros inferiores imagine
Lower crossbars imagine
Montants inférieurs imagine

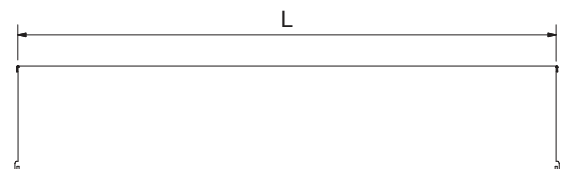

Dimensiones Dimensions Dimensions			
L	Kg	Barcode	€
665	2,7	014252	
1.075	4,0	014254	
1.315	5,4	014256	

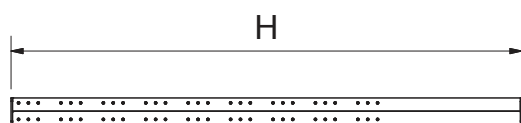

Dimensiones Dimensions Dimensions			
H	Kg	Barcode	€
1.700	6	013602	

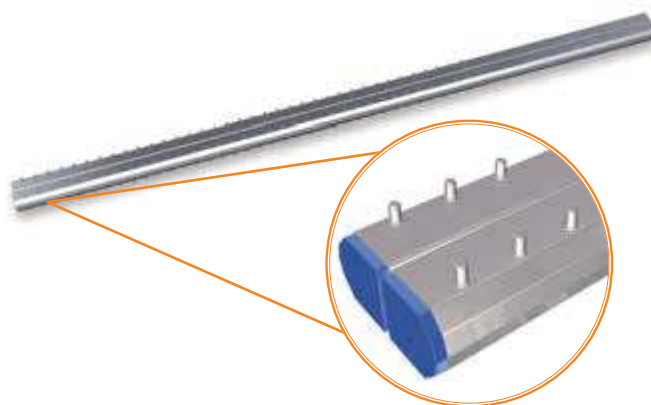

Montante imagine suspendida
Support for Imagine hanging wall shelf
Support pour Imagine murale suspendue

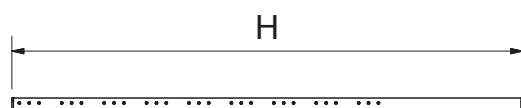

Dimensiones Dimensions Dimensions			
H	Kg	Barcode	€
860	1,5	013606	
1.700	3,0	013604	

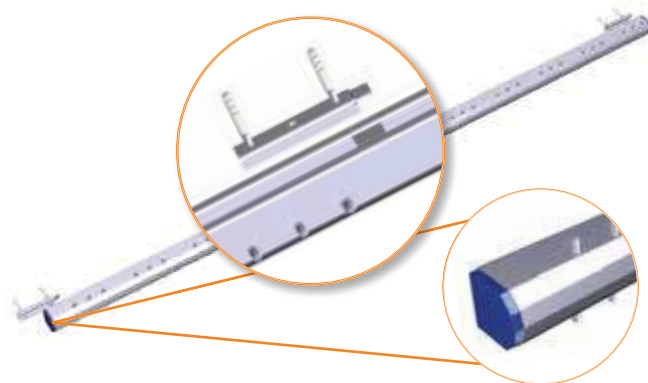

Cartelas imagine
Brackets imagine
Consoles imagine

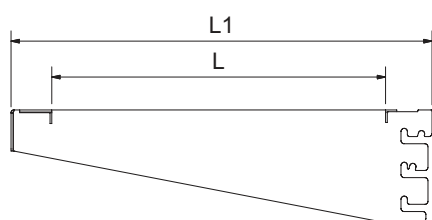

Dimensiones Dimensions Dimensions			
L	L1	Kg	Barcode
325	410	1,8	014002
530	615	2,5	014004



Largueros superiores imagine
Upper crossbars imagine
Montants supérieurs imagine

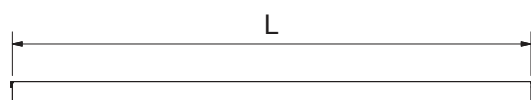

Dimensiones Dimensions Dimensions			
L	Kg	Barcode	€
665	1,3	014202	
1.075	1,9	282806	
1.315	2,4	014204	



Estantes inox imagine

Stainless steel shelves imagine
Étagères en acier inoxydable imagine

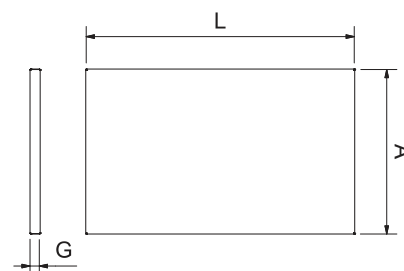

Dimensiones					
Dimensions					
Dimensions					
L	A	G	Kg	Barcode	€
325	325	20	1,0	013402	
530	325	20	1,5	013404	
530	530	20	2,0	013406	

Estantes fibra imagine

Polyethylene shelves imagine
Étagères en polyéthylène imagine

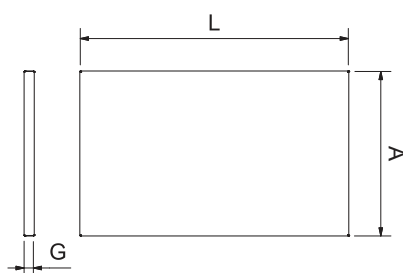
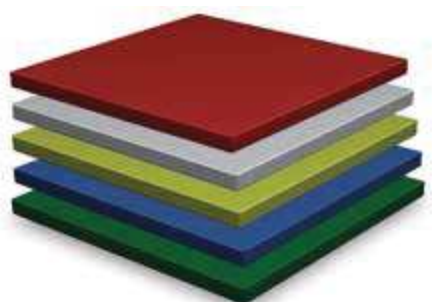

Dimensiones						
Dimensions						
Dimensions						
Color	L	A	G	Kg	Barcode	€
Red	325	325	20	2,12	434602	
	530	325	20	3,45	434604	
	530	530	20	5,62	434606	
White	325	325	20	2,12	434610	
	530	325	20	3,45	434612	
	530	530	20	5,62	434614	
Yellow	325	325	20	2,12	434620	
	530	325	20	3,45	434622	
	530	530	20	5,62	434624	
Blue	325	325	20	2,12	434630	
	530	325	20	3,45	434632	
	530	530	20	5,62	434634	
Green	325	325	20	2,12	434640	
	530	325	20	3,45	434642	
	530	530	20	5,62	434644	

Hacer agujero de desbarasado a estantes imagine

Imagine shelf perforation for waste chutes
Perforer étagère imagine pour évacuation de déchets

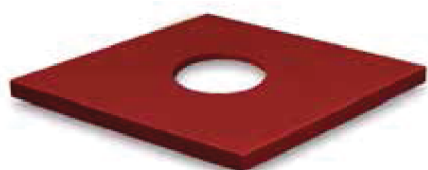

Dimensiones			
Dimensions			
Dimensions			
Color	Material	Barcode	€
Grey	Acero inoxidable Stainless steel Acier inoxydable	015002	
Red	Fibra Fibre Fibre	434802	

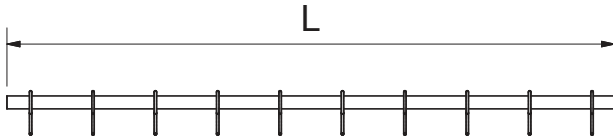

Dimensiones Dimensions Dimensions	Número de ganchos incluidos Number of hooks included Número de crochets inclus	Kg	Barcode	€
L				
650	10	0,30	014602	
1.060	10	0,50	014604	
1.300	20	0,65	014606	

Dimensiones Dimensions Dimensions				Barcode
H	E	D		
60	16	3	022502	

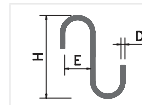

45

Boxes modulares
 Modular boxes
 Boxes modulaires

Con este sistema de boxes modulares ya puede configurar a su medida las mesas, fregaderos, estanterías, tajos, etc.

Basados en las dimensiones internacionales GASTRONORM están fabricados totalmente en acero inoxidable. Su diseño moderno y funcional permite adaptar guías, cajones, cubetas, puertas etc.

With this system of modular boxes now you can adapt to your needs tables, sink units, shelving units, chopping blocks, etc.

Based in the international dimensions GASTRONORM, it is made totally from stainless steel. Its innovative and functional design allows the fitting of elements such as guides, drawers, pans, doors, etc.

Avec le système de boxes modulaires maintenant vous pouvez adapter à vos besoins tables, éviers, étagères, billots, etc.

Ce système, basé dans les mesures internationales GASTRONORM, est fabriqué totalement en acier inoxydable. Sa conception moderne et fonctionnelle permet d'adapter guides, tiroirs, bacs, portes, etc.



226

Cajón acoplado a estante 2/1 imagine
 Drawer assembled to shelf 2/1 imagine
 Tiroir assemblé à étagère 2/1 imagine



	Barcode	€
	085450	
	085452	

Porta-precios imagine

Price-holder imagine
Porte prix imagine



Se acoplan con facilidad a los largueros superiores.
Easy to assemble to the upper crossbars.
Facilité d'assemblage aux montants supérieurs.

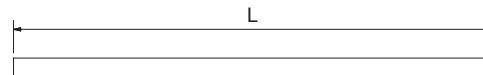

Dimensiones Dimensions Dimensions			
L	Gr	Barcode	€
650	65	415250	
1.060	105	415252	
1.300	130	415254	

Útil de montaje imagine

Assembly tool imagine
Outil de montage imagine



Facilita considerablemente el montaje.
It makes the assembly greatly easier.
Il facilite l'assemblage.

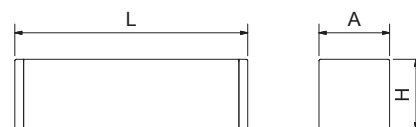

Dimensiones Dimensions Dimensions					
L	A	H	Gr	Barcode	€
125	40	40	180	014402	

Peto transparente imagine

Transparent front panel for imagine
Panneau frontal transparent pour imagine

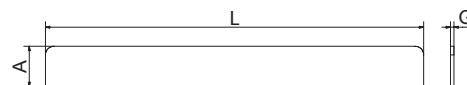

Dimensiones Dimensions Dimensions					
L	A	G	Gr	Barcode	€
655	70	6	175	014802	
1.065	70	6	250	014804	
1.305	70	6	375	014806	

Pinzas porta-precios imagine

Price-holder clamp for imagine
Pince à dessin porte-prix pour imagine



Height	Gr	Barcode	€
100	40	413402	
105	40	413406	
150	48	413404	
190	42	413408	
145	38	413410	

317

Cubetas Gastronorm.
 Gastronorm trays.
 Bacs gastronorm.



434602



18



Estante en fibra de polietileno con agujero.
 Perforated polyethylene shelves.
 Étagères perforées en polyéthylène.



486004



282



Contenedor inoxidable con tapa.
 Stainless steel dustbin.
 Poubelle inox.

89

Cuchillería profesional.
 Professional cutlery.
 Coutellerie professionnelle.

Includo / Included / Inclus
 Opcional / Optional / Optionnel



Dimensiones					
Dimensions					
Dimensions					
L	A	H	Kg		€
764	1.050	1.700	61	CE-A	
1.174	1.050	1.700	71	CE-B	
1.414	1.050	1.700	82	CE-C	

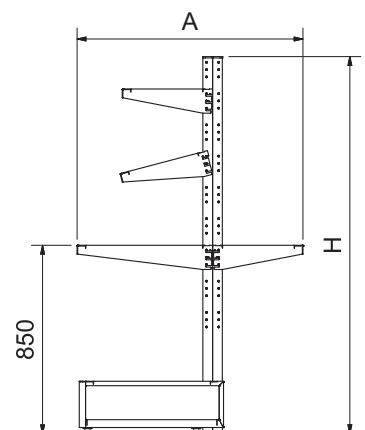
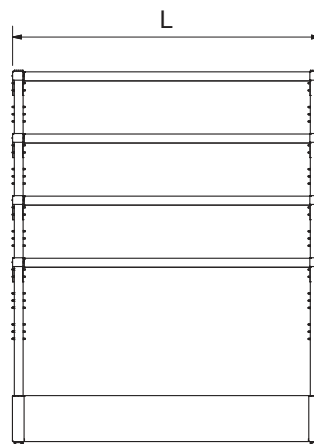

Mesa mural con estantes sobremesa serie imagine

Wall-side table with superior shelves series imagine

Table murale avec étagères sur table modèle imagine



014602 19

Kit para colgar utensilios.
Tool-holder kit.
Kit pour suspendre outils.



448616 259

Guante de malla de acero inoxidable Expert.
Expert stainless steel mesh glove.
Gant en maille d'acier inoxydable Expert.



454802 162

Escurridor de platos y vasos de 510 mm.
Plate and glasses 510 mm rack.
Égouttoir pour assiettes et verres 510 mm.



124

Tijeras pescadero.
Fish scissors.
Ciseaux à poisson.



434602 18

Estante en fibra de polietileno con agujero.
Perforated polyethylene shelves.
Étagères perforés en polyéthylène.



89

Cuchillería profesional.
Professional cutlery.
Coutellerie professionnelle.



317

Cubetas Gastronorm.
Gastronorm trays.
Bacs gastronorm.



486004 282

Contenedor inoxidable con tapa.
Stainless steel dustbin.
Poubelle inoxydable.



085452 19

Cajón acoplado.
Coupled drawer.
Tiroir accouplé.

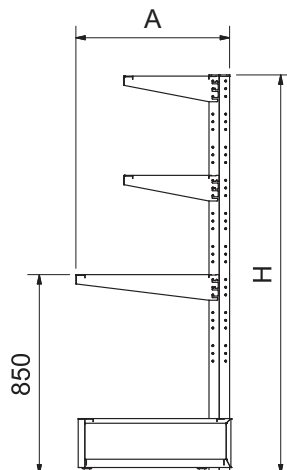
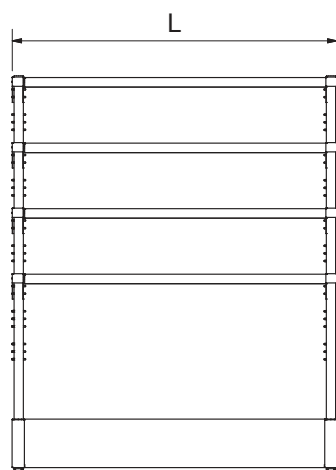

Includido / Included / Inclus
 Opcional / Optional / Optionnel

Dimensiones					
Dimensions					
Dimensions					
L	A	H	Kg	Barcode	€
764	655	1.700	55	MES-A	
1.174	655	1.700	64	MES-B	
1.414	655	1.700	73	MES-C	



454802 162

Escurreidor de platos y vasos de 510 mm.
Plate and glasses 510 mm rack.
Égouttoir pour assiettes et verres 510 mm.



081802 332

Porta notas mural acoplado.
Wall mounted note holder.
Porte notes mural.



434442 88

Mortero de fibra.
Mortar.
Mortier.



080202 293

Dispensador de bobinas para envolver de 350 mm.
Dispenser rolls of wrapping material.
Dévidoir de rouleaux pour protéger les aliments.



434440 87

Rodillo de fibra.
Rolling pin.
Rouleau.

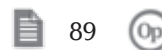

89

Cuchillería profesional.
Professional cutlery.
Coutellerie professionnelle.



486004 282

Contenedor inoxidable con tapa.
Stainless steel dustbin.
Poubelle inoxydable.



431608 76

Fibra estándar azul de 500x300x20 mm.
Blue standard fibre 500x300x20 mm.
Fibre standard bleue 500x300x20 mm.



041202 133

Portacuchillos con doble alojamiento de sobremesa.
Plated knife holder for mounting.
Porte-couteaux plaqué pour adosser.



- Incluido / Included / Inclus
- Opcional / Optional / Optionnel

Dimensiones					
Dimensions					
Dimensions					
L	A	H	Kg	Barcode	€
764	1.255	1.700	77	CES-A	
1.174	1.255	1.700	95	CES-B	
1.414	1.255	1.700	115	CES-C	

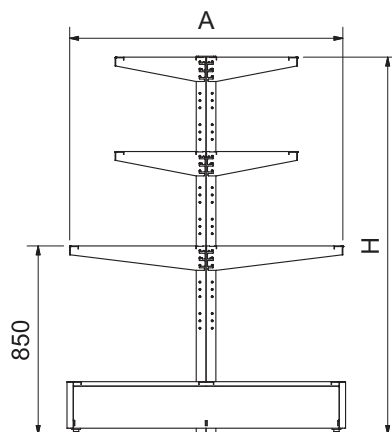
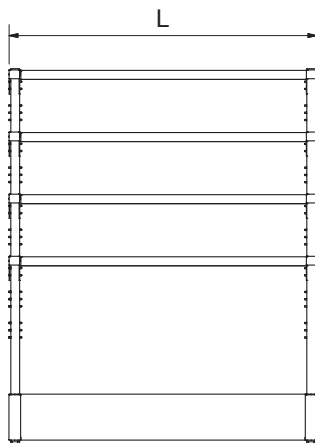

Estanterías modulares

Modular shelving
Rayonnages modulaires

Características de fabricación:

Construidas totalmente en acero inoxidable, acabado satinado.
Doble pliegue con pestaña aplastada en los estantes, para evitar cortes y ganar resistencia. Fácil montaje.
Gran diversidad de medidas para una máxima adaptación a su lugar de colocación.
Alturas disponibles desde 850 mm, para su utilización como mesas de apoyo, carros, etc., hasta 2950 mm para el mejor aprovechamiento del espacio.
Dos espesores de chapa disponibles y con la opción de poder solicitarlas con refuerzos soldados en su base, ver página 27.
Se puede regular la altura entre estante y estante cada 100 mm, con posibilidad de poner un estante a ras de suelo.
Pies regulables para una mayor estabilidad en cualquier suelo.
Posibilidad de colocación de ruedas, ver página 353.
Opcionalmente se pueden suministrar con kit de pletinas. Ver página 27.

Manufacturing characteristics:

Made totally in stainless steel shiny finished. Double fold with crushed fringe in shelves, to avoid any bad cut and to increase the resistance. Easy mounting.
Great diversity of measures to allow a maximum fitting to the mounting room.
Available heights from 850 mm for its usage as auxiliar tables, chars, etc. up to 2950 mm for the best use of the room.
Sheet thick available in two measures with the option of order them with reinforcements fixed at its base. See page 27.
Height adjustment every 100 mm, with the possibility of mounting one shelf at the ground level.
Adjustable feet to allow a higher stability on any floor.
Possibility of fixing wheels. See page 353.
They can be supplied optionally with plates and hooks. See page 27.

Caractéristiques de fabrication:

Construit totalement en acier inoxydable finition satinée. Double pli avec rebord aplati pour éviter des coupures et gagner en résistance. Facilité de montage.
Grand diversité de mesures pour une maxime adaptation a l'endroit de installation.
Hauteur disponibles depuis 850 mm pour l'utilisation comme tables auxiliaires, chariots, etc, jusqu'à 2950 mm pour le mieux profit de l'espace.
Deux épaisseurs de tôle disponibles avec l'option de les solliciter avec renforcements soudés dans sa base. Voir page 27.
Hauteur réglable tous les 100 mm, avec la possibilité de monter une étagère au niveau du sol.
Pieds réglables pour une plus grande stabilité dans n'importe quel sol.
Possibilité de montage de rouelles. Voir page 353.
Optionnellement elles peuvent être fournies avec un kit de platines et crochets. Voir page 27.



Detalle de kit de pletinas acoplado a estantería.
Detail of plates set coupled in shelving.
Détail de kit de pletines accouplé dans le rayonnage.



Posibilidad de acoplar cajones a estantes.
Drawer coupled possibility.
Possibilité de tiroir accouplé.

349



Detalle del pie del soporte de estantería.
Detail of shelving support base.
Détail du pied du support de rayonnage.



Posibilidad de acoplar ruedas a soportes de estantería.
Castor fixed to shelving supports possibility.
Possibilité de rouelle accouplée dans supports de rayonnage.

Cuadro comparativo de estanterías modulares con estantes lisos de 0.8 mm

Comparative table of modular shelving with non-perforated 0.8 mm shelves
Tableau comparatif de rayonnages modulaires avec étagères lisses de 0,8 mm

Dimensiones Dimensions Dimensions			Número de estantes Number of shelves Número d'étagères			
L	A	H	3 €	4 €	5 €	6 €
800	300	1.750				
1.000	300	1.750				
1.200	300	1.750				
1.400	300	1.750				
800	400	1.750				
1.000	400	1.750				
1.200	400	1.750				
1.400	400	1.750				
800	500	1.750				
1.000	500	1.750				
1.200	500	1.750				
1.400	500	1.750				
800	600	1.750				
1.000	600	1.750				
1.200	600	1.750				
1.400	600	1.750				

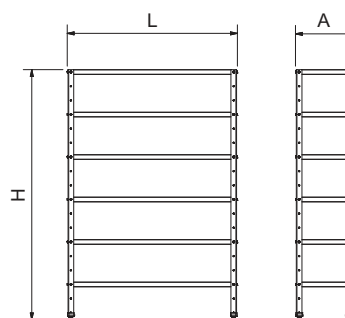

Estos precios incluyen estantes, soportes, tornillos y tuercas.

Shelves, shelving supports, nuts and bolts included in these prices.

Etagères, supports de rayonnage et vis à écrou compris dans ces prix.

Cuadro comparativo de estanterías modulares con estantes lisos de 1.5 mm

Comparative table of modular shelving with non-perforated 1.5 mm shelves
Tableau comparatif de rayonnages modulaires avec étagères lisses de 1.5 mm

Dimensiones Dimensions Dimensions			Número de estantes Number of shelves Número d'étagères			
L	A	H	3 €	4 €	5 €	6 €
800	300	1.750				
1.000	300	1.750				
1.200	300	1.750				
1.400	300	1.750				
800	400	1.750				
1.000	400	1.750				
1.200	400	1.750				
1.400	400	1.750				
800	500	1.750				
1.000	500	1.750				
1.200	500	1.750				
1.400	500	1.750				
800	600	1.750				
1.000	600	1.750				
1.200	600	1.750				
1.400	600	1.750				

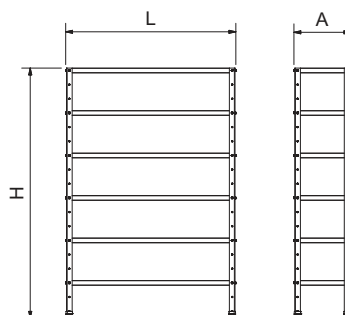

Estos precios incluyen estantes, soportes, tornillos y tuercas.

Shelves, shelving supports, nuts and bolts included in these prices.

Etagères, supports de rayonnage et vis à écrou compris dans ces prix.

Estantes lisos para estanterías modulares

Flat shelves for modular shelving

Etagères lisses pour rayonnages modulaires

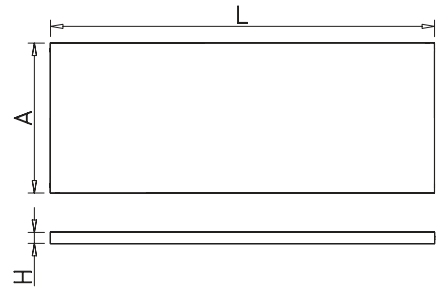

Dimensiones Dimensions Dimensions			Estantes de 0,8 mm 0,8 mm shelves Étagères 0,8 mm			Estantes de 1,5 mm 1,5 mm shelves Étagères 1,5 mm		
L	A	H	Kg	Barcode	€	Kg	Barcode	€
800	300	35	2,20	010202		4,16	010402	
1.000	300	35	2,78	010204		5,14	010404	
1.200	300	35	3,24	010206		6,02	010406	
1.400	300	35	3,76	010208		7,02	010408	
800	400	35	2,76	010210		5,32	010410	
1.000	400	35	3,40	010212		6,30	010412	
1.200	400	35	4,04	010214		7,71	010414	
1.400	400	35	4,76	010216		9,00	010416	
800	500	35	3,36	010218		6,16	010418	
1.000	500	35	4,14	010220		7,68	010420	
1.200	500	35	4,90	010222		9,12	010422	
1.400	500	35	5,56	010224		10,58	010424	
800	600	35	3,86	010226		7,30	010426	
1.000	600	35	4,94	010228		8,98	010428	
1.200	600	35	5,60	010230		10,70	010430	
1.400	600	35	6,50	010232		12,34	010432	

Soportes de estantería

Shelving supports

Supports de rayonnage



Inc

Características:

Espesor del acero 2 mm.

Admiten estante a nivel del suelo.

Separación entre taladros de 100 mm.

Characteristics:

Stainless steel thickness 2 mm.

Shelf allowed at ground level.

Holes are 100 mm apart.

Caractéristiques:

Acier inoxydable épaisseur 2 mm.

Étagère admise au niveau du sol.

Ecart des trous tous les 100 mm.

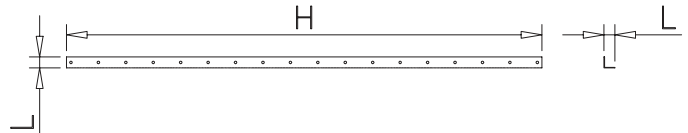

Dimensiones Dimensions Dimensions				
H	L	Kg	Barcode	€
850	40x40	1,05	011002	
1.050	40x40	1,24	011004	
1.450	40x40	1,62	011006	
1.750	40x40	2,02	011008	
2.050	40x40	2,38	011010	
2.350	40x40	2,58	011012	
2.950	40x40	2,69	011014	

Refuerzos soldados a estantes

Welded reinforcements for shelves
Renforts soudés aux étagères

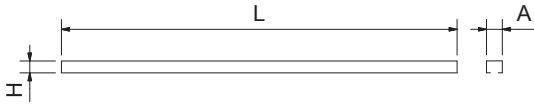

Dimensiones Dimensions Dimensions						
L	A	H	Kg	Barcode	€	
800	40	30	1,02	011202		
1.000	40	30	1,18	011204		
1.200	40	30	1,41	011206		
1.400	40	30	1,65	011208		

Características:
Aumentan la capacidad de carga. Ver página 28

Characteristics:
Increase load-capacity. See page 28

Caractéristiques:
Sert à améliorer la capacité de chargement. Voir page 28



Tornillos y tuercas para estantes

Nut and bolt for shelves
Vis à écrou pour étagères

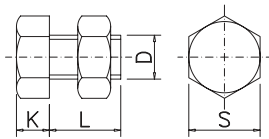

Dimensiones Dimensions Dimensions						
	D	L	S	K	Gr	€
Tornillo Bolt Vis	M8	12	13	5,3	7,00	421012
Tornillo Bolt Vis	M8	25	13	5,3	11,00	421016 *
Tuerca Nut Écrou	M8		13	5,3	4,00	421056



Tornillo para unión de estanterías.
Screw for shelving units union.
Vis pour union d'étagères.

8 tornillos y tuercas por estante.
8 nut and bolt for shelf.
8 vis à écrou pour étagère.



Kit de pletinas para estanterías

Plate kit for shelves
Kit de platines pour rayonnages

Dimensiones Dimensions Dimensions	Kit 1 Pletina One plate kit Kit de 1 platine	Pletina Opcional Optional plate Platine en option			
L	A	Barcode	€	Barcode	€
800	300	012802		012850	
	400	012810			
	500	012818			
	600	012826			
1.000	300	012804		012852	
	400	012812			
	500	012820			
1.200	300	012806		012854	
	400	012814			
	500	012822			
1.400	300	012808		012856	
	400	012816			
	500	012824			
	600	012832			

Dotación de cada kit de pletinas:

Una pletina de la medida del largo de la estantería, con una "U" soldada a cada extremo. Dos pletinas de la medida del ancho de la estantería preparadas para atornillar a los soportes. Tornillería.

Each plate kit consists of:
One plate of the same length as the shelves with a U-shaped bracket welded to either end. Two plates of the same width as the shelves ready to be bolted to the supports. Nuts and bolts.

Dotation de chaque kit de platines:
Une platine mesurant la largeur de l'étagère avec deux "U" soudés à chaque extrémité. Deux platines mesurant la largeur de l'étagère conçues pour être vissées aux supports. Visserie.



Resistencia de carga por estante de 0.8 mm de espesor

Load strength per 0.8 mm thick shelf

Résistance de charge par étagère de 0,8 mm d'épaisseur



Las cargas se consideran uniformemente repartidas en la superficie del estante.

It is assumed that loads are evenly distributed on the shelf surface.

On considère que les charges sont réparties uniformément sur la surface de l'étagère.

Resistencia de carga en Kgs Kgs load strength Résistance de charge Kgs				
Dimensiones Dimensions Dimensions	Sin refuerzos Without reinforcement Sans renforts	1 refuerzo 1 reinforcement 1 Renforts	2 refuerzos 2 reinforcement 2 Renforts	3 refuerzos 3 reinforcement 3 Renforts
800x300	225	275	325	
1.000x300	175	225	275	
1.200x300	125	150	200	
1.400x300	100	125	175	
800x400	200	250	300	350
1.000x400	150	200	250	300
1.200x400	100	125	175	225
1.400x400	75	100	150	200
800x500	200	250	300	350
1.000x500	150	200	250	300
1.200x500	100	125	175	225
1.400x500	75	100	150	200
800x600	175	225	275	325
1.000x600	125	175	225	275
1.200x600	75	100	150	200
1.400x600	50	75	125	175

Resistencia de carga por estante de 1.5 mm de espesor

Load strength per 1,5 mm thick shelf

Résistance de charge par étagère par 1,5 mm d'épaisseur



Las cargas se consideran uniformemente repartidas en la superficie del estante.

It is assumed that loads are evenly distributed on the shelf surface.

On considère que les charges sont réparties uniformément sur la surface de l'étagère.

Resistencia de carga en Kgs Kgs load strength Résistance de charge Kgs				
Dimensiones Dimensions Dimensions	Sin refuerzos Without reinforcement Sans renforts	1 refuerzo 1 reinforcement 1 Renforts	2 refuerzos 2 reinforcement 2 Renforts	3 refuerzos 3 reinforcement 3 Renforts
800x300	300	350	400	
1000x300	250	300	375	
1200x300	150	200	275	
1400x300	125	175	225	
800x400	275	325	375	475
1000x400	225	275	350	450
1200x400	125	175	250	350
1400x400	100	150	200	300
800x500	275	325	375	475
1000x500	225	275	350	450
1200x500	125	175	250	350
1400x500	100	150	200	300
800x600	250	300	350	450
1000x600	200	250	325	425
1200x600	100	150	225	325
1400x600	75	125	175	275

Soporte de sobremesa y mural porta-cubetas Gastronorm

Worktop and wall fixed Gastronorm trays holder
Support sur table et mural porte-cuveaux Gastronorm



Características:

Fabricado en acero inoxidable.

Para uso de sobremesa o fijación mural (incluye tornillos para su fijación a la pared).

Admite cubetas de hasta 200 mm de profundidad.

Empleando los perfiles divisorios podrá ubicar numerosas combinaciones según sus necesidades.

Posibilidad de regular la inclinación.

No incluye las cubetas ni los perfiles.

Cubetas y tapas. Ver página 317.

Perfiles divisorios. Ver página 323.

Asa universal para cubetas. Ver página 320.

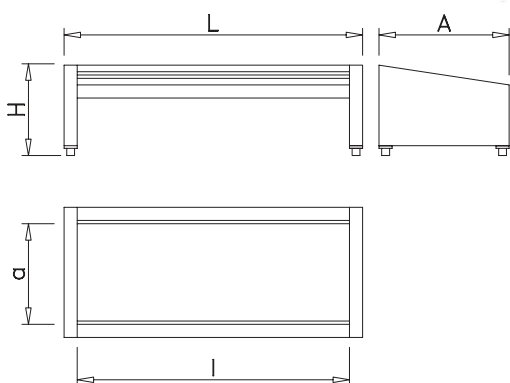

Dimensiones

Dimensions
Dimensions

L	A	H	I	a	Kg	Barcode	€
740	390	275	655	325	6,0	082803	
1.150	390	275	1.065	325	7,5	082804	
1.390	390	275	1.305	325	8,5	082806	

Characteristics:

Manufactured in stainless Steel.

For worktop or wall mounted use (screws included).

It can lodge Gastronorm containers up to 200 mm depth.

You can carry out numerous combinations depending on your needs by using the dividing sections.

Possibility of lean adjustment.

Gastronorm containers and dividing sections not included.

Lids and containers, see page 317.

Dividing sections, see page 323.

Standard handle for Gastronorm containers, see page 320.

Caractéristiques:

Fabriqu  en acier inoxydable.

Il est con u   poser sur table ou   accrocher au mur.

Il peut loger des bacs Gastronorm jusqu'  200 mm de profondeur.

Vous pouvez r aliser des combinaisons nombreuses selon vos besoins en utilisant les sections de s paration

Possibilit  de r gler l'inclinaison.

Bacs GN et des sections de s paration n'ont pas inclus.

Couvercles et les r cipients, voir page 317.

Sections de s paration, voir page 323.

Poign e standard pour r cipients Gastronorm, voir page 320.

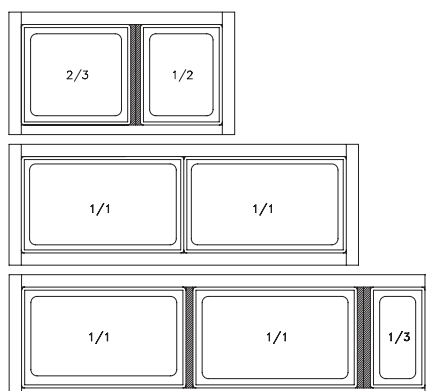

Estantes murales cartelas modelo compacto

Fixed wall shelves

Etagères murales modèle compact



Characteristics:

The main characteristic of these shelves is that they are made in one only piece, with all their angles welded, back fringe as well as double fold to avoid any burrs or dirtiness deposits.

These shelves generally use our bolt code 421034 and our plug code 409824. See page 65.

Caractéristiques:

La principale caractéristique de ces étagères est qu'elles sont fabriquées d'une seule pièce, avec tous ses arêtes soudées, dossierer postérieur, ainsi que double pli, pour éviter des bavures et l'accumulation du saleté.

Généralement, cet étagères utilisent notre vis code 421034 et notre cheville code 409824. Voir page 65.



Tornillos y tacos no incluidos en el precio.
Bolts and plugs not included in the price.
Les vises et les chevilles ne sont pas inclus dans le prix.

Características:

La principal característica de estos estantes es su construcción en una sola pieza, con todas sus aristas soldadas y peto posterior, así como doble pliegue aplastado para evitar rebabas y depósitos de suciedad.

Estos estantes se suelen atornillar a la pared con nuestro tornillo cód. 421034 y con el taco cód. 409824. Ver página 65.

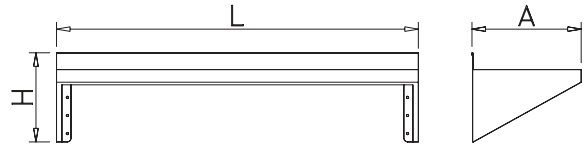

Dimensiones Dimensions Dimensions					
L	A	H	Kg	Barcode	€
1.000	300	245	3,50	011402	
1.250	300	245	4,10	011404	
1.500	300	245	4,70	011406	
1.000	400	245	4,28	011408	
1.250	400	245	5,04	011410	
1.500	400	245	5,80	011412	
1.000	500	245	5,08	011414	
1.250	500	245	6,00	011416	
1.500	500	245	6,70	011418	

Estantes murales de tubo

Tube wall shelves

Etagères murales en tube



These shelves generally use our bolt code 421034 and our plug code 409824. See page 65.

Généralement, cet étagères utilisent notre vis code 421034 et notre cheville code 409824. Voir page 65.



Tornillos y tacos no incluidos en el precio.
Bolts and plugs not included in the price.
Les vises et les chevilles ne sont pas inclus dans le prix.

Estos estantes se suelen atornillar a la pared con nuestro tornillo cód. 421034 y con el taco cód. 409824. Ver página 65.

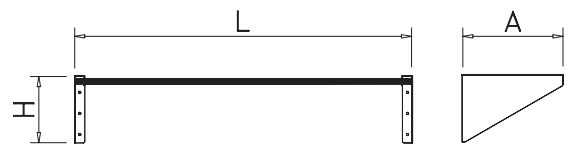

Dimensiones Dimensions Dimensions					
L	A	H	Kg	Barcode	€
750	300	200	4,00	011902	
1.000	300	200	4,11	011904	
750	400	200	4,80	011906	
1.000	400	200	5,65	011908	

Estante mural especial microondas

Wall shelf - specially for microwaves

Etagère murale spéciale micro - ondes



Tornillos y tacos no incluidos en el precio.
Bolts and plugs not included in the price.
Les vises et les chevilles ne sont pas inclus dans le prix.

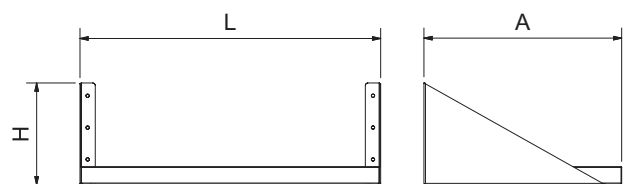

Dimensiones Dimensions Dimensions					
L	A	H	Kg	Barcode	€
590	388	200	3,00	015202	



Basados en las medidas internacionales GASTRONORM. Podrá intercambiar los estantes por recipientes, parrillas y fibras GN.

Based in the international standard GASTRONORM. You can replace the shelves for Gastronorm containers, grills and GN fibres.

Basé dans le standard international GASTRONORM. Vous pouvez remplacer les étagères pour les bacs, grilles GN et plaques GN.



Cubetas Gastronorm.
Gastronorm trays.
Cuveau gastronorm.

Configuraciones:
Range of configurations:
Gamme de configurations:

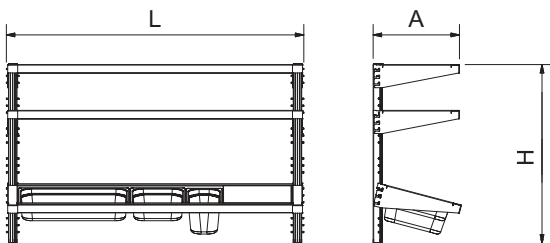
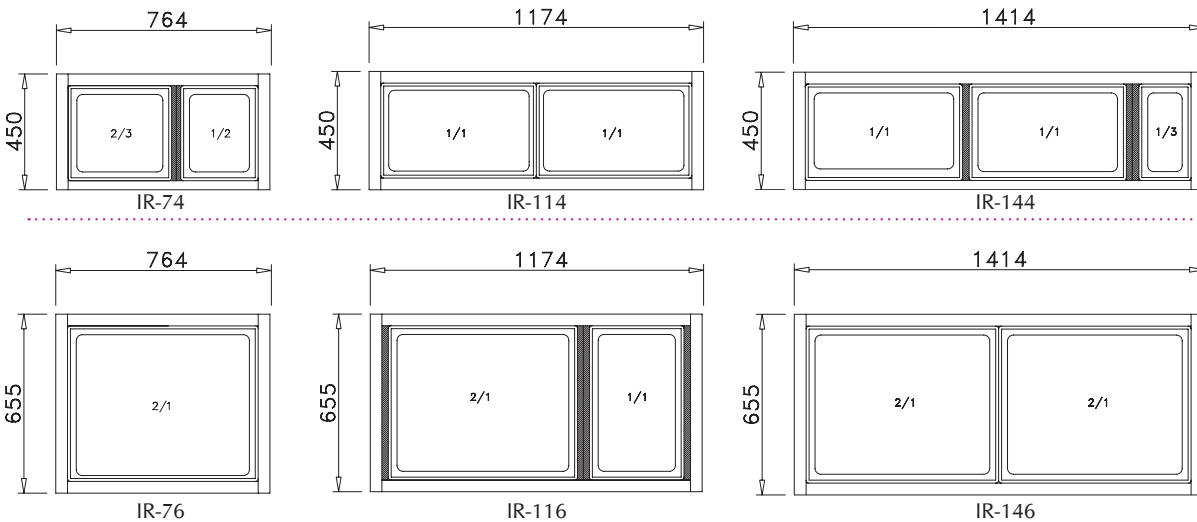

Se instala con facilidad y rapidez. Los estantes se regulan a la altura deseada SIN HERRAMIENTAS, incluso su inclinación.

It can be mounted easily and quickly. Height and lean adjustment according to your needs WITHOUT TOOLS.

Installation facile et rapide. Réglage en hauteur et inclinaison selon vos besoins SANS OUTILS.

Ⓞ Opcional / Optional / Optionnel

Estantes regulables imagine
Imagine adjustable wall shelves
Étagères réglables imagine

Montantes
Uprights
Montants



Dimensiones Dimensions Dimensions				
L	A	Kg	Barcode	€
764	413	8,2	IR-74	
1.174	413	10,4	IR-114	
1.414	413	12,4	IR-144	
764	614	10,6	IR-76	
1.174	614	12,8	IR-116	
1.414	614	17,8	IR-146	

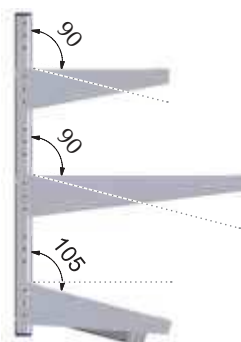

Dimensiones Dimensions Dimensions			
H	Kg	Barcode	€
860	1,5	013606	
1.700	3,0	013604	

Cuadro comparativo de estantes murales con cartelas

Comparative view of wall shelves with brackets

Tableau comparatif d'étagères murales avec équères

Recta
Upright bracket
Équères droite



Vuelta
Reverse bracket
Équères renversée



Estos estantes se suelen atornillar a la pared con nuestro tornillo cód. 421034 y con el taco cód. 409824. Ver página 65.

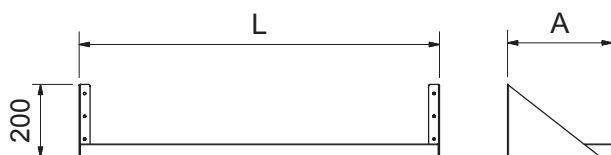
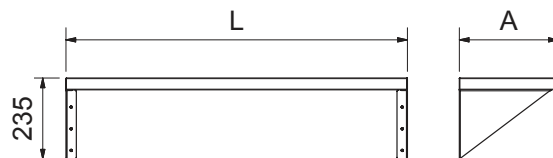

Tornillos y tacos no incluidos en el precio.
Bolts and plugs not included in the price.
Les vises et les chevilles ne sont pas inclus dans le prix.

These shelves generally use our bolt code 421034 and our plug code 409824. See page 65.

Généralement, ces étagères utilisent notre vis code 421034 et notre cheville code 409824. Voir page 65.

Dimensiones
Dimensions
Dimensions

L	A	€
800	300	
1.000	300	
1.200	300	
1.400	300	
800	400	
1.000	400	
1.200	400	
1.400	400	
800	500	
1.000	500	
1.200	500	
1.400	500	

Cuadro comparativo de estantes murales con palomillas

Comparative view of wall shelves with supports

Tableau comparatif d'étagères murales avec supports

Recta
Upright support
Support droite



Vuelta
Reverse support
Support renversée



Estos estantes se suelen atornillar a la pared con nuestro tornillo cód. 421034 y con el taco cód. 409824. Ver página 65.

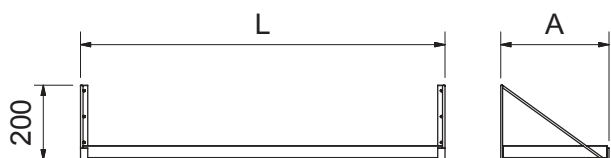
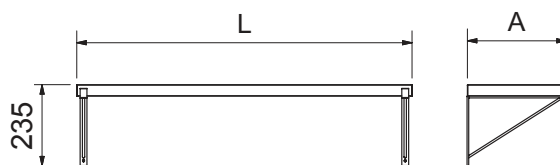

Tornillos y tacos no incluidos en el precio.
Bolts and plugs not included in the price.
Les vises et les chevilles ne sont pas inclus dans le prix.

These shelves generally use our bolt code 421034 and our plug code 409824. See page 65.

Généralement, ces étagères utilisent notre vis code 421034 et notre cheville code 409824. Voir page 65.

Dimensiones
Dimensions
Dimensions

L	A	€
800	300	
1.000	300	
1.200	300	
1.400	300	
800	400	
1.000	400	
1.200	400	
1.400	400	
800	500	
1.000	500	
1.200	500	
1.400	500	

Estantes murales
Wall shelves
Etagères murales

Dimensiones Dimensions Dimensions					
L	A	H	Kg	Barcode	€
800	300	35	2,20	011602	
1.000	300	35	2,78	011604	
1.200	300	35	3,24	011606	
1.400	300	35	3,76	011608	
800	400	35	2,76	011610	
1.000	400	35	3,40	011612	
1.200	400	35	4,04	011614	
1.400	400	35	4,76	011616	
800	500	35	3,36	011618	
1.000	500	35	4,14	011620	
1.200	500	35	4,90	011622	
1.400	500	35	5,56	011624	

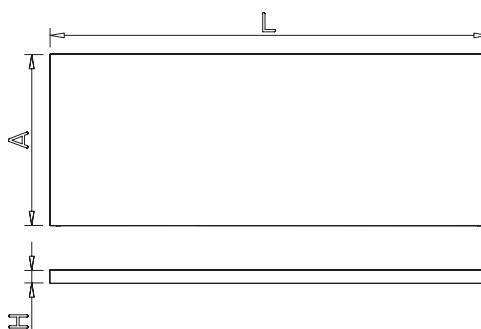

Cartelas
Brackets
Équerres

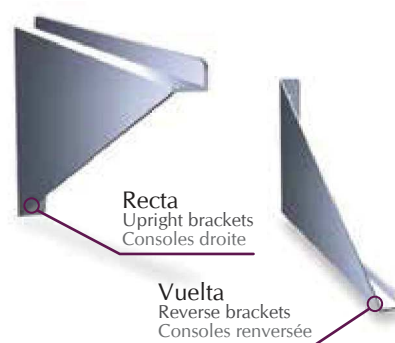
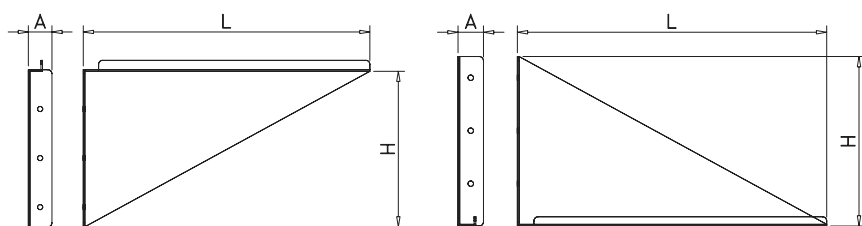

Dimensiones Dimensions Dimensions								
L	A	H	Gr	Barcode 1	Barcode 2	Barcode 3	Barcode 4	€
265	20	200	500	012402	012403	012602	012603	
365	20	200	700	012404	012405	012604	012605	
465	20	200	850	012406	012407	012606	012607	

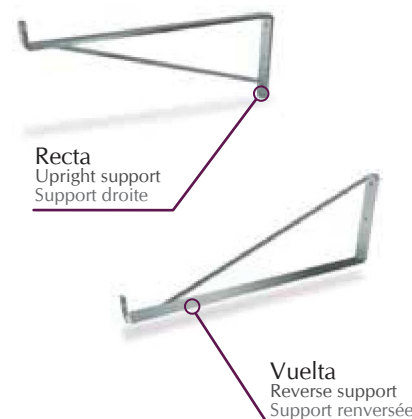
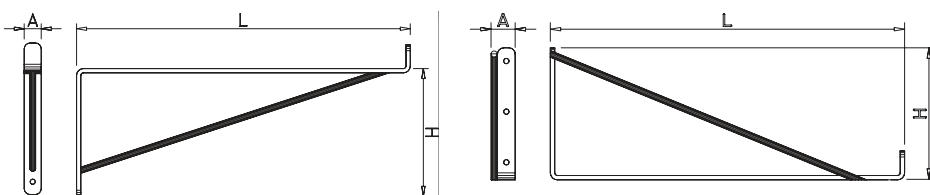

Dimensiones Dimensions Dimensions								
L	A	H	Gr	Barcode 1	Barcode 2	Barcode 3	Barcode 4	€
300	20	200	440	012002	012202	012203		
400	20	200	580	012004	012204	012205		
500	20	200	700	012006	012206	012207		

Estante mural porta-barquetas

Wall shelf for meat plastic trays
Étagère murale porte-barquettes alimentaires



Estos estantes se suelen atornillar a la pared con nuestro tornillo cód. 421034 y con el taco cód. 409824. Ver página 65.

These shelves generally use our bolt code 421034 and our plug code 409824. See page 65.

Généralement, cet étagères utilisent notre vis code 421034 et notre cheville code 409824. Voir page 65.



Tornillos y tacos no incluidos en el precio.
Bolts and plugs not included in the price.
Les vises et les chevilles ne sont pas inclus dans le prix.

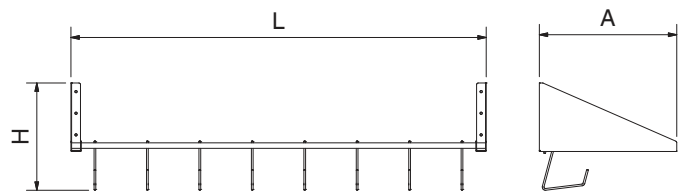
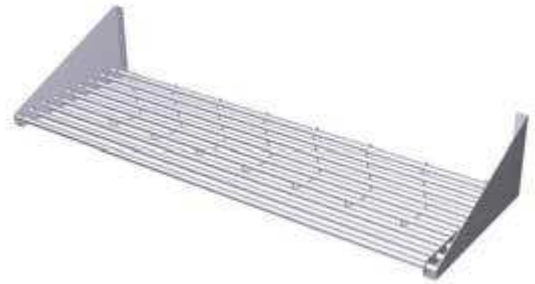

Dimensiones
Dimensions
Dimensions

L	A	H	N° Ganchos Hooks Crochets	Kg	Barcode	€
1.200	400	310	8	6,80	011920	

Estante mural de fibra abatible

Polyethylene hinged wall shelf
Console murale battante en polyéthylène

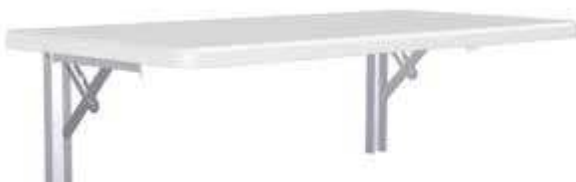

Estos estantes se suelen atornillar a la pared con nuestro tornillo cód. 421034 y con el taco cód. 409824. Ver página 65.



421254



52

Cartelas abatibles para estantes murales.
Hinged bracket for wall shelf.
Équerre battante pour étagère murale.

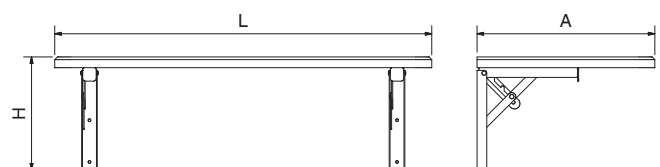

Dimensiones
Dimensions
Dimensions

L	A	H	Kg	Barcode	€
700	330	205	2,00	013206	

These shelves generally use our bolt code 421034 and our plug code 409824. See page 65.

Généralement, cet étagères utilisent notre vis code 421034 et notre cheville code 409824. Voir page 65.



Tornillos y tacos no incluidos en el precio.
Bolts and plugs not included in the price.
Les vises et les chevilles ne sont pas inclus dans le prix.

Estante mural inclinado para cestas de lavavajillas

Sloping inclined wall rack shelf
Étagère murale inclinée pour paniers de lavage

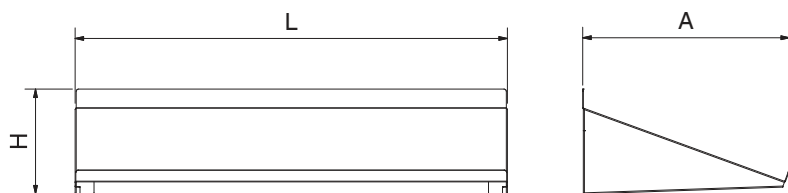

Dimensiones Dimensions Dimensions

L	A	H		Kg		€
1.020	488	248	500x500	8,70	011430	
1.550	488	248	500x500	12,50	011432	

Características:

Este taburete metálico lleva en su base tres ruedas que permiten su fácil traslado de un sitio a otro con un simple empujón del pie, sin embargo en el momento en que usted sube sobre él queda totalmente fijado al suelo gracias a su burlete circular que se adhiere como una ventosa.

Disponible en otros colores, a partir de 24 unidades.

Characteristics:

This metallic stool has on its base three castors that allow moving it from one place to another easily, just pushing it with your foot. Furthermore, whenever you are standing on it, it is firmly fixed to the floor, as if it were a suction pad, thanks to its rounded rubber strip.

Available in other colors. From 24 units.



Caractéristiques:

Ce tabouret métallique a dans sa base trois rouelles qui permettent le déplacer facilement de long en large, avec un seul poussé du pied. En plus, lorsqu'on monte sur lui, il reste totalement fixé au sol, comme une ventouse, grâce à sa bande ronde en caoutchouc.

Disponible dans d'autres couleurs. A partir de 24 unités.

Taburete con ruedas

Rolling step-stool
Tabouret marche - pied roulant

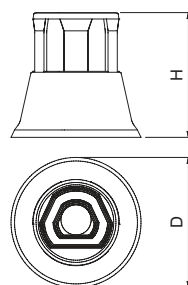

Dimensiones Dimensions Dimensions

D	H	Kg			€
430	430	4,6		482202	
430	430	4,6		482204	



Rueda de repuesto para taburetes

Spare wheel for step-stools

Rouelle de rechange pour tabouretes



Repuesto para 482202 y 482204.
Spare part for 482202 and 482204.
Rechange pour 482202 et 482204.



482250

Accesorios para estanterías

Accessories for shelves

Accessoires pour étagères



Cajones
Drawers
Tiroirs

348



Boxes modulares
Modular boxes
Boxes modulaires

226



Ruedas
Wheels
Rouelle

353



Taco regulable para soporte de estantería
Adjustable block for shelving support
Taquet réglable pour supports de rayonnage

354



Cubetas Gastronorm lisas
Non-perforated Gastronorm containers
Bacs Gastronorm lisses

317