



BATLOGGER

Manual

Firmware version V 2.3



elekon

Elekon AG
Cheerstrasse 16
CH-6014 Luzern

www.batlogger.ch

Table of contents

1 Notes.....	3
2 Overview.....	4
2.1 General.....	4
2.2 Device variants.....	4
2.3 Data storage.....	4
2.4 Recording.....	5
2.5 Check and play of recorded #****.wav files.....	5
2.6 Global positioning and time recording / GPS.....	5
2.7 Recording the mode of operation of the BATLOGGER.....	5
2.8 Accessories.....	6
2.8.1 SD card.....	6
2.8.2 Ultrasonic microphone.....	6
2.8.3 Microphone extension (optional).....	6
2.8.4 Extension kit green 100m (optional).....	6
2.8.5 Headphones (optional).....	7
2.8.6 Strongbox (optional).....	7
3 Preparation.....	8
3.1 Battery charging.....	8
3.2 Adjusting parameters.....	8
4 Switching the BATLOGGER on and off (with main menu and info lines).....	9
4.1 Activating the BATLOGGER.....	9
4.2 Shutting the BATLOGGER off (manual and automatically).....	9
4.3 Download of new firmware when starting up.....	10
5 Record (bat calls).....	11
5.1 Manual Trigger (Triggering recording by keystroke).....	11
5.2 Continuous Trigger (Continuous recording).....	11
5.3 Crest- and Period – Trigger ("Automatic" recording).....	12
5.4 Live monitoring A.....	13
5.5 Menu functions in record mode.....	13
5.6 Delayed recording (Recording in time windows).....	14
5.7 Interval recording (Recording in intervals).....	14
6 Process (Playback, analyse and erase stored wav files).....	15
6.1 Choose folder (if used).....	15
6.2 Choose Recording.....	16
6.3 Play.....	16
6.4 Play All.....	16
6.5 Analyse.....	16
6.6 Delete (Delete recordings).....	17
7 Setup (Settings).....	18
7.1 Operation.....	18
7.2 Setup-Menu.....	19
8 Recordings and Files.....	27
8.1 The audio data file "xxxxxxx.wav" (e.g. 10160435.wav).....	27
8.2 Meta data file "xxxxxxx.xml" (Bsp. 10160435.xml).....	28
8.3 Parameter file "BATPARS.xml".....	29
8.4 Log file "BATREC.log".....	31
8.5 Google-Earth file "route.kml".....	32
8.6 Track file "xxxxxxx.gpx" (e.g. 10160435.gpx).....	32
9 Technical specifications.....	33

1 Notes



Development: The BATLOGGER was developed in a cooperation of the Swiss Federal Research Institute [WSL](#) and the University of Applied Sciences Northwestern Switzerland FHNW, with financial help from the Environmental Research of the Swiss Federal Office for the Environment FOEN.



Environmental conditions: The BATLOGGER is housed in a robust synthetic case for measuring devices, and it is operated through a polyester foil keyboard. With the many openings for GPS, microphone, memory card, charging plug etc., it does only reach imperviousness level IP 30 and therefore is not protected against water. When used in the field, unobserved and for extended periods of time, the logger should be stowed in a waterproof box (Strongbox Part # 212.006 .. 008) or bag, with the microphone externally connected through a cable.



Microphone / Ultrasonic sensor: An active electret microphone is used as plug-in ultrasound sensor. Attention has to be paid to a proper fitting of the microphone in its plug. The microphone itself can be damaged by water. It must be protected from rain and extreme humidity, and it requires corresponding positioning. For special recording purposes, the microphone can be connected with the logger through a shielded stereo audio cable of no more than 2 m length.



Speaker ^A: The speaker can also be used for monitoring during recording. Depending on environment and volume this may lead to acoustic feedback (loud whistling). In this case, reduce the volume and hold the BATLOGGER further away from reflecting objects such as walls or your own body or use headphones.



Li-Ion battery: The internal power is provided by a lithium-ion battery of 3,6 V and 4600 mAh. When transporting and storing several BATLOGGERS together, the corresponding regulations have to be followed.



Storage media SD – card: The BATLOGGER uses SD / SDHC /SDXC cards with FAT32 file system as storage media. Tests have shown, that cards of different vendors may vary in writing and erasing speed. We refrain from giving recommendations for specific products or vendors, as offered sizes and technologies change constantly, which may also influence card performance.



GPS receiver: GPS requires a direct line of sight between the receiver and the satellites. If an object is within direct path, the accuracy suffers due to reflections and attenuation of the signals. This is particularly problematic in urban areas, in valleys and on mountain slopes. Even smaller objects (tree cover, roof, human body) can lead to reflections and attenuation. For accurate positioning it is therefore essential to have unobstructed view to the sky.

Legende for display illustrations:

On the following pages the operation of the BATLOGGER is explained using symbolic representations of the LCD display. The illustrations are only for the sake of clarity and understanding, and do not necessarily reflect what you see on the device.

Display symbology (default settings) in the following explanations:

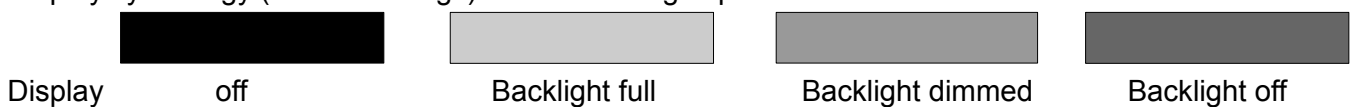

2 Overview

2.1 General

The BATLOGGER is a data logger, which records ultrasound vocalisations of bats in real-time, and stores them for later processing on a SD / SDHC memory card (real-time recording system).

In a real-time recording system, the ultrasonic signal is digitized directly without change and with high sampling rate. Hereby the BATLOGGER continuously analyses the signal and only stores it to the SD card when bat activity is detected. The Signal is recorded to internal RAM and subsequently, if certain criteria is fulfilled stored, as recording files (sequences of echolocation calls) onto SD card.

Apart from the bat calls, which are stored as WAVE files, additional information is written in text format into a “.xml” file, which stores all the settings of the BATLOGGER at the time of recording, including time, date and location of the recording (GPS data), and the temperature of the logger.

To allow a later overview over all deployments of the BATLOGGER, its operating state is being written to a “LOG” file on the SD card.

The BATLOGGER is thus especially suitable for autonomous operation and long-term monitoring.

2.2 Device variants

The BATLOGGER is offered in a slightly extended version since the end of 2012 (Model: BATLOGGER M). It additionally includes an integrated mixer for live monitoring of the bat calls during recording. BATLOGGER M has speaker holes on the top, 3-line display and has Part #: 212.013 on the nameplate.

Since mid-2014 BATLOGGER M uses next to GPS also GLONASS satellites to determine position. In these devices, the receiving antenna is located inside the unit.

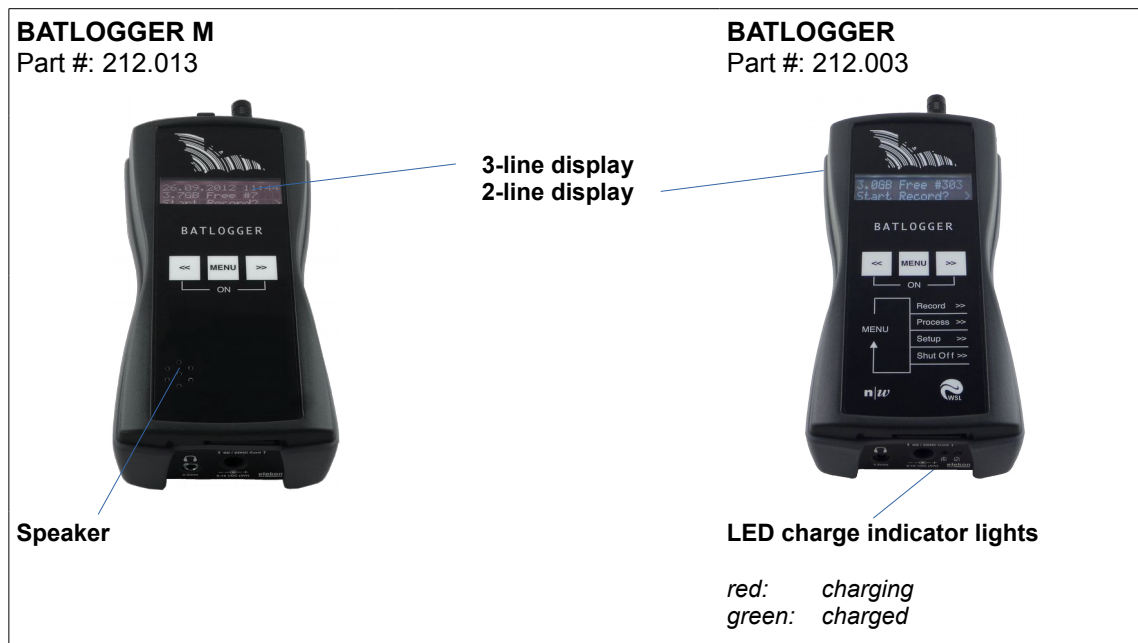

2.3 Data storage

The audio files are stored on memory card as #****.wav files (where # = 4 digit serial number of the BATLOGGER), with consecutive numbering (****). For every #****.wav file, an #****.xml file is stored, which contains all parameter settings, date, time, geographic position and temperature at the time of recording of the corresponding WAVE file. Ultrasound data of the microphone are first written to the internal Random Access Memory (RAM) of the BATLOGGER. After termination of a single recording sequences (*Recording...*), the data are stored automatically from RAM to the SD card (*Saving... #****.wav*). During this storage time (duration depends on file size and card type), the BATLOGGER is blocked.

2.4 Recording

The BATLOGGER can be operated in different ways. As a basic principle, when the logger is in "Record" mode, the signal from the microphone is constantly written to internal RAM (*Sampling...*).

If the BATLOGGER is set for **continuous recording**, the RAM is filled with data and thereafter data are written to the memory card. As the logger's RAM is limited to 32 MB, the length of a single recording sequence can not exceed approx. 53 seconds, but can be set to less. Subsequently this recording sequence will be written as #****.wav file to the SD card and a new recording will start, thereby overwriting data in RAM. The time required for data storage to the memory card is largely depending on the file size but also on the type of card. In general the writing of the file should require significantly less time than the recording itself.

In **manual recording** the triggering has to be performed through the key pad and may also be stopped this way. If a manual stop does not occur, the recording will stop automatically after a user selectable manual trigger time (default = 10 sec), and the #****.wav file be written to memory card.

In **automatic recording** the signal from the microphone is constantly monitored and the recording started automatically, when a triggering event is registered (detected ultrasound signal). The duration of such recordings depends on the presence of the triggering criteria. The default setting allow for a recording duration which includes 0.5 seconds before the first and 1 second after the last trigger event (pre- and post-trigger). With the default settings, the shortest recording duration is therefore 1.5 seconds, which corresponds to roughly 1 MB of data on the SD card.

2.5 Check and play of recorded #****.wav files

For immediate control, single stored audio files can be replayed through headphones or speaker^A in mixer or time expansion mode. Ultrasound signals are transformed to audible range, in time expansion slowed down by a user selectable factor x (default x = 10). A stored sequence therefore requires an x-fold playback time of the original recording to monitor. Only recorded files can be played back and listened to. Additionally recording details of a file such as date, time, length, peak frequency and more can be displayed.

Single recordings on the memory card can also be erased through this mode. Erasing the complete memory card must be achieved by formatting it (Settings menu).

2.6 Global positioning and time recording / GPS

The BATLOGGER is equipped with a GPS receiver. Its positioning and time data are stored in parallel to the #****.wav file in a corresponding #****.xml file, and into a Google-Earth -.kml file. Further on, the travelled track can be recorded to a GPX file.

If no GPS reception is possible, a manual position can be setup (see page 19). It will then be stored together with the recording data. It is also possible to navigate to this position by using the GPS status display ("Show Status"). There the distance and heading from the current position to the manual position is displayed continuously (find starting point again, Geocaching, ...).

2.7 Recording the mode of operation of the BATLOGGER

For later control of a BATLOGGER's state, its mode of operation is sequentially written to memory card into a separate "log"-File (BATREC.log). This "BATREC.log" file is constantly added to, and will not be overwritten. However, formatting the SD card will also erase this log file.

2.8 Accessories

2.8.1 SD card

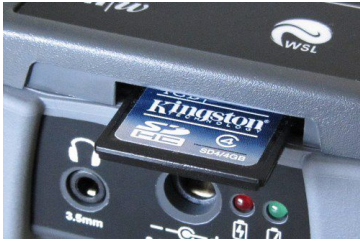

- For data storage a removable SD / SDHC / SDXC card up to 128 GB card size is used (32 MB to 128 GB tested). When the term “SD card” is used, always an SD / SDHC / SDXC card is meant. The card must be formatted as FAT32.
- SD cards larger than 32 GB (SDXC cards) may be formatted with exFAT upon delivery and must be formatted by the BATLOGGER with FAT32 before use. To do this insert the SD card into the BATLOGGERS memory card slot and turn it on the BATLOGGER. You will be asked whether the card should be formatted. Press **»** to format and confirm with **«** **»** .

CAUTION: All data on the SD card will be deleted.

- The SD card must be inserted into the memory card slot until it clicks into place before turning on the BATLOGGER. To remove the SD card, turn off the BATLOGGER and press the SD card in gently. The SD card pops out and can be removed.
- SD cards may have a write protect switch that prevents writing to the cards when the switch is on LOCK.
- A recent version of BATPARS Editor software (Windows and Mac) is stored on the included SD card. The executable file is in directory Software/BATPARS and can be started from there directly. Installation is not required.
- A recent version of BatExplorer PC software is stored on the included SD card. It must be installed on the computer before first use. It can be found in the directory Software/BatExplorer.

2.8.2 Ultrasonic microphone



As ultrasonic sensor a pluggable active electret microphone is used. The microphone must be plugged into the corresponding microphone jack on top of the device before use. Please make sure the microphone is plugged in completely until dead stop to ensure maximum contact.

Different microphone types can be used:

- Ultrasonic microphone (Part # 212.215)
MEMS-Electret technology, omnidirectional
- Ultrasonic microphone FG black (Part # 212.233)
Electret condenser technology, omnidirectional, good weather resistance
When using it with a BATLOGGER (Part # 212.003) ^A, an extension cable (see below) must be used. With a BATLOGGER M (Part # 212.013) this is not needed.



If the microphone is damaged, it can be replaced with a new, functional replacement microphone (Part # 212.215 or Part # 212.233).

2.8.3 Microphone extension (optional)



For special recordings a commercially available, shielded audio cable (stereo) up to about 2m length may be inserted between BATLOGGER and microphone (Microphone extension Part # 212.004).

2.8.4 Extension kit green 100m (optional)



In order to record at greater distance to the BATLOGGER the extension kit green 100m can be used instead of the supplied microphone. The special microphone FG green can be located up to 100 meters away. For example, it is possible to attach the microphone on the top of a measuring mast, while the BATLOGGER can be placed protected and easily accessible on the ground.

(Extension kit green 100 Part # 212.015)

1. Insert the cables plug into the microphone jack of the BATLOGGER
2. If needed: Loosen the grounding wire from the cable, strip and contact it with appropriate means to ground.
3. Insert the ultrasonic microphone FG green into the protective tube. Make sure the microphone is plugged in completely until dead stop to ensure maximum contact.
4. Place and fasten the protective tube at the recording location. The protective tube may not be placed with the opening upwards, as otherwise rain or moisture can collect in the tube and the microphone may be damaged. It is advised to install it horizontally or with the opening slightly downwards.

If used together with a StrongBox (see below), the cables plug must be inserted into the protective tube of the StrongBox.

2.8.5 Headphones (optional)



To listen to recordings a standard headphone with 3.5mm plug is used (Part # 212.012). Plug your headphone into the headphone jack and adjust the volume to a comfortable level in the Setup menu (see also below).

2.8.6 Strongbox (optional)

The Strongbox (Part # 212.006 .. 008) provides long-term surveillance and monitoring of bat habitats. It protects the BATLOGGER against weather and allows to run it independently up to 19 nights.



Before using the Strongbox its battery must be fully charged with the special charger supplied.



Only the charger supplied must be used with the Strongbox, not the BATLOGGER power supply. Please refer to the instructions of the charger.

Using the BATLOGGER with the Strongbox:

1. Remove the ultrasonic microphone from the BATLOGGER.
2. Plug in the power plug of the Strongbox into the power supply connector of the BATLOGGER.
3. Plug in the microphone extension cable into the microphone jack of the BATLOGGER.
4. Plug in the ultrasonic microphone into the protective tube of the microphone extension. Make sure the microphone is plugged in completely until dead stop to ensure maximum contact. To remove the microphone from the protective tube, insert the included hose through the microphone and pull the hose with the microphone out of the tube gently.
5. Place the BATLOGGER into the Strongbox.
6. Turn on the BATLOGGER and put it into record mode. Settings to trigger and recording time windows are shown below.
7. Close the Strongbox. The microphone extension cable must be clamped into the provided opening of the Strongbox on the blue-clad parts of the cable. Take care that the Strongbox is closed completely to ensure proper sealing.

3 Preparation

3.1 Battery charging

Upon delivery the battery of the BATLOGGER may not be fully charged. Please charge the battery before first use.

1. Connect the supplied AC adapter to the BATLOGGER's power supply connector.
2. Plug the AC adapter into a power outlet.
3. Charging begins when the charging indicator lights red or, for BATLOGGER M, "charging..." is displayed.
4. Charging is complete when the charging indicator turns green or, for BATLOGGER M, "charged" is displayed. The charging time can take several hours, depending on the state of charge.

Note: The BATLOGGER can also be operated with the AC adapter connected to e.g. extend the operation time.

3.2 Adjusting parameters

Basically the BATLOGGER can be used directly with factory settings. For some applications such as long-term monitoring parameters must be adapted accordingly.

Ideally, adjusting BATLOGGER parameters should take place before use, directly on a PC or Mac.

1. Insert the supplied SD card into the memory card reader of your computer and start the BATPARS editor software directly from the SD card.
2. Open the file "BATPARS.xml" which is stored in the root directory of the SD card by clicking the "Open..." button.
3. Change parameters as needed. e.g. set capture time window (schedule) for long-term monitoring and directly check programmed times in advance.
4. Save the parameter file by clicking *Save*. The parameters are now on the SD card.
5. Close the BATPARS editor software with "Close".
6. Insert the SD card now in the BATLOGGER. The parameters are now loaded at startup.

See also on page 19 and page 29.

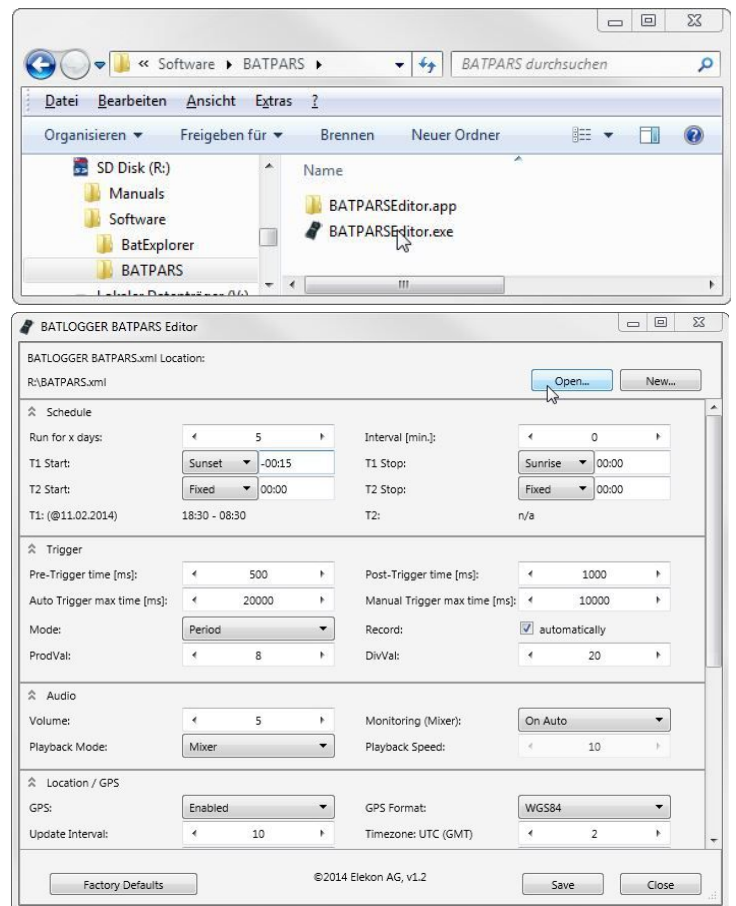

4 Switching the BATLOGGER on and off (with main menu and info lines)

4.1 Activating the BATLOGGER

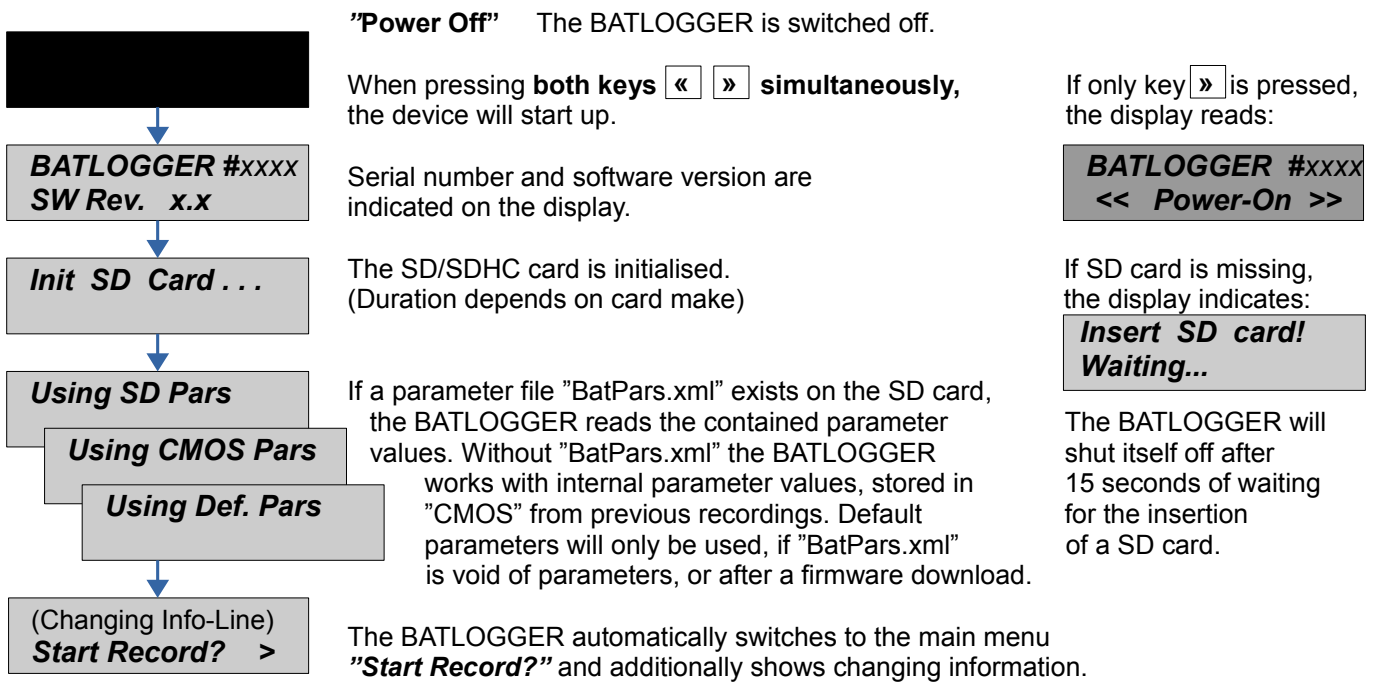

Main menu with info lines

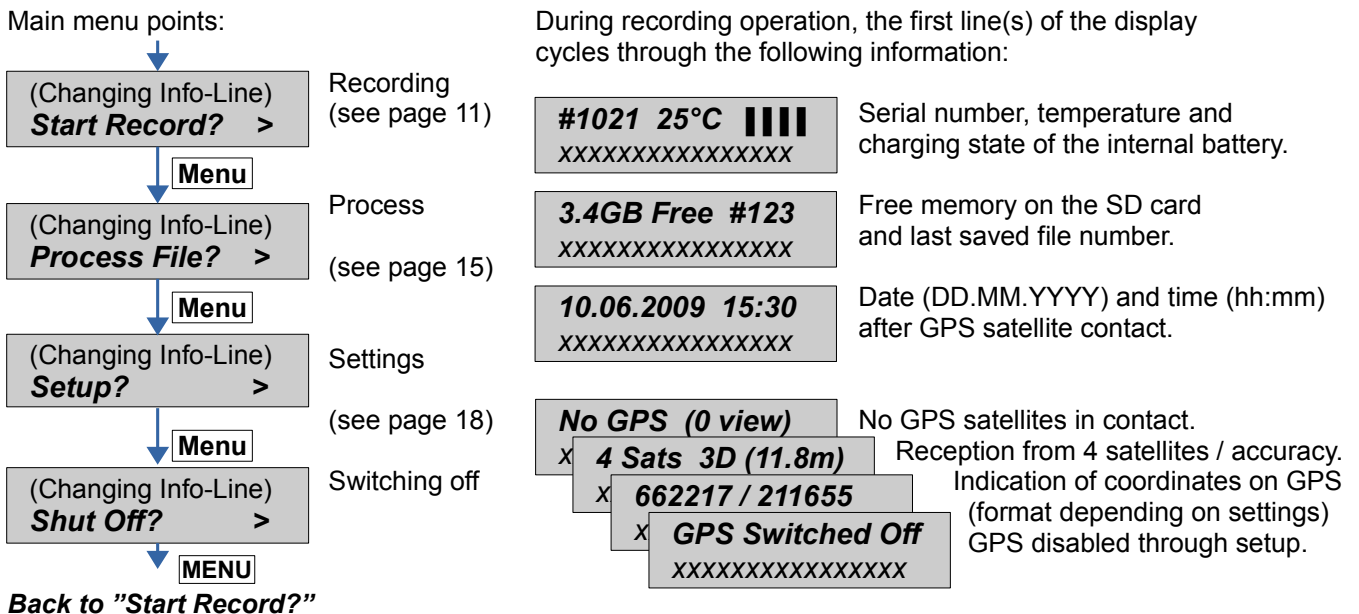

4.2 Shutting the BATLOGGER off (manual and automatically)

Press key `Menu` in the main menu until **"Shut Off?"** appears.

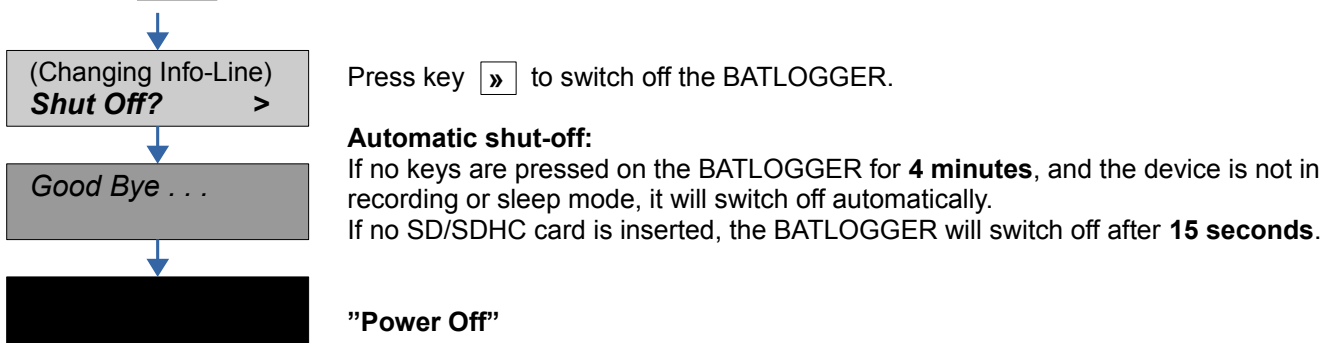

4.3 Download of new firmware when starting up

Download possible new firmware version from the BATLOGGER-Homepage www.batlogger.ch and copy it to the SD card.

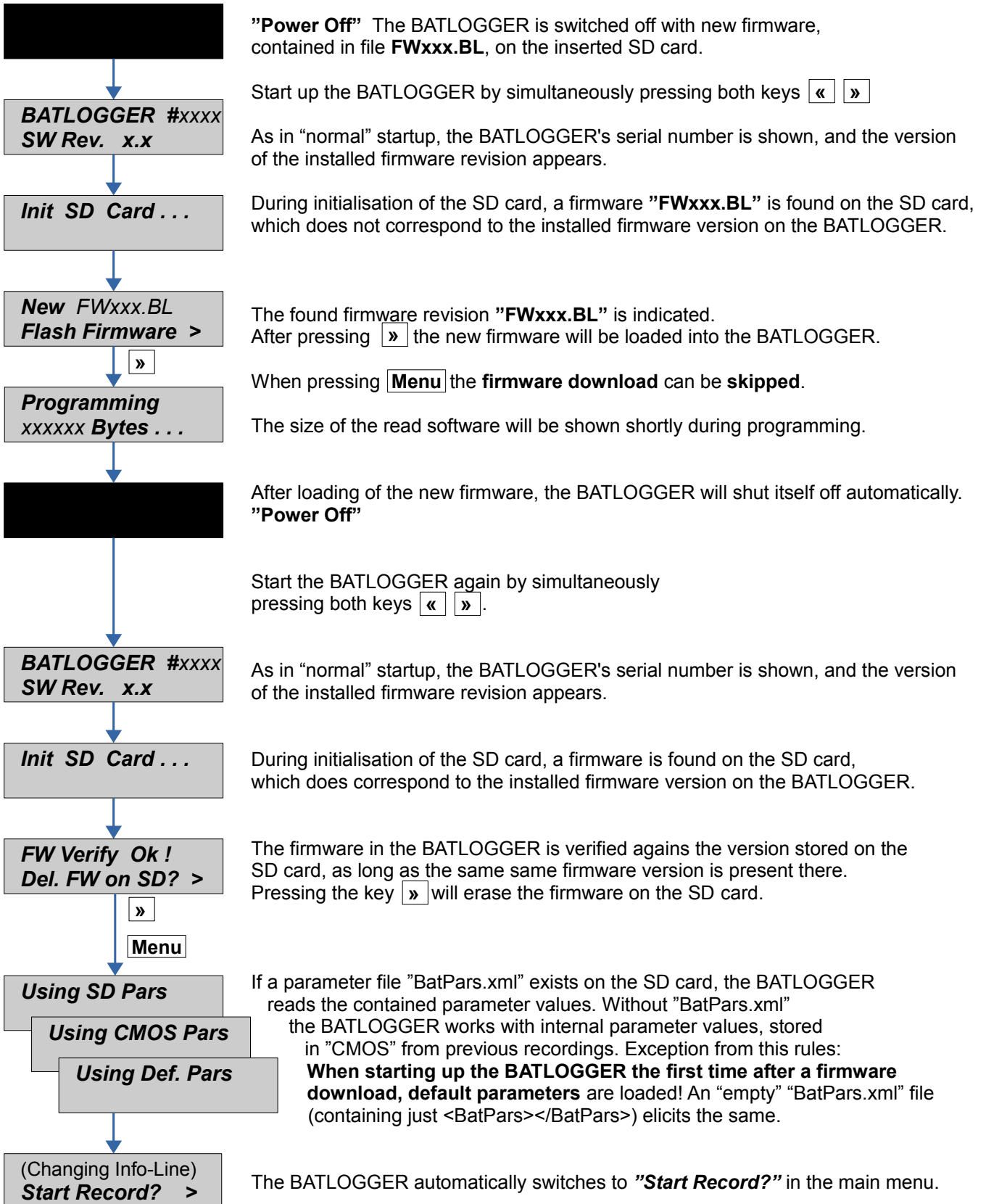

5 Record (bat calls)

- Recording with automatic and manual trigger
- Continuous recording
- Recording in preset time windows

5.1 Manual Trigger (Triggering recording by keystroke)

Proceed with key **Menu** in the main menu to **"Start Record"**.

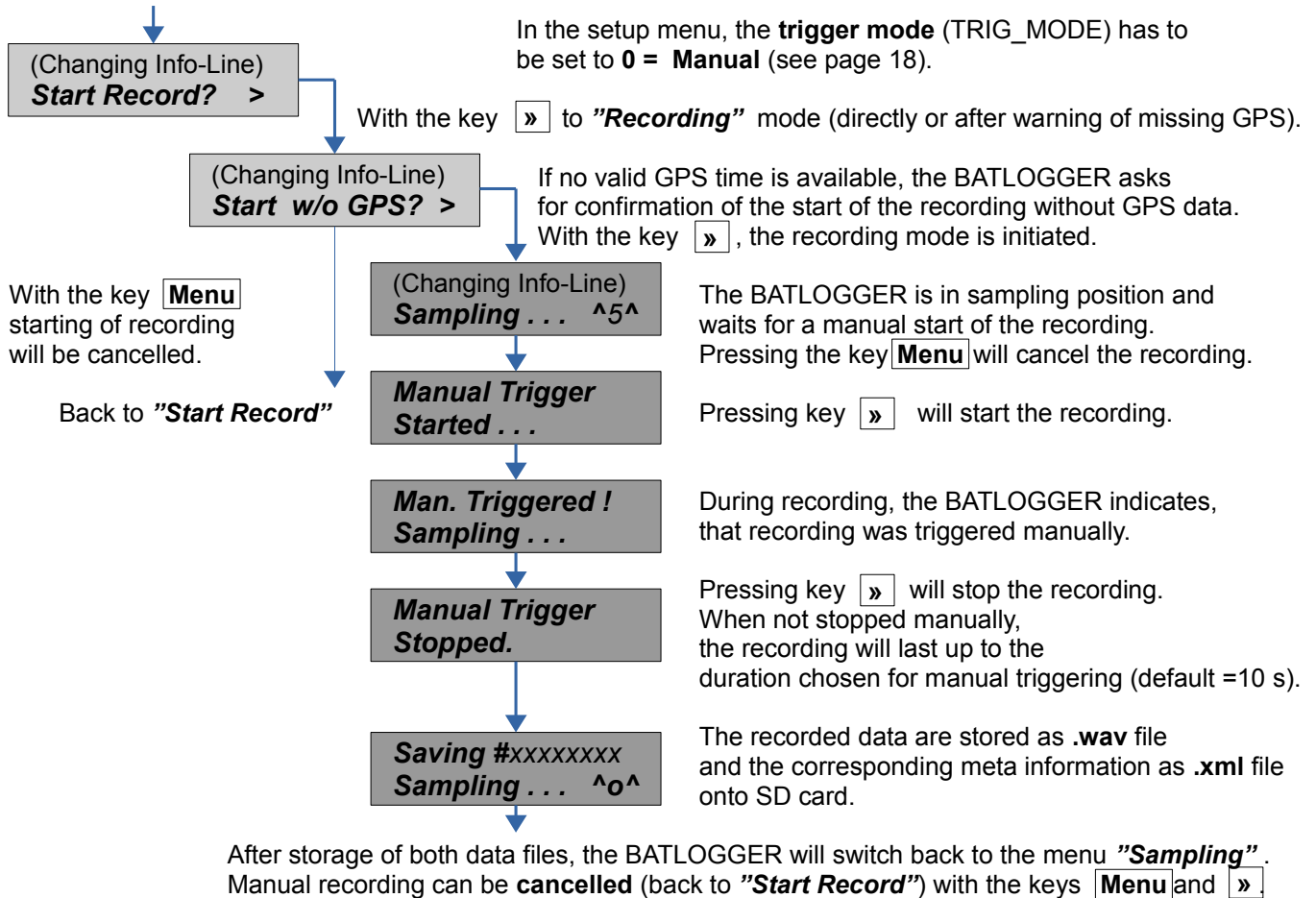

5.2 Continuous Trigger (Continuous recording)

Proceed with key **Menu** in the main menu to **"Start Record"**.

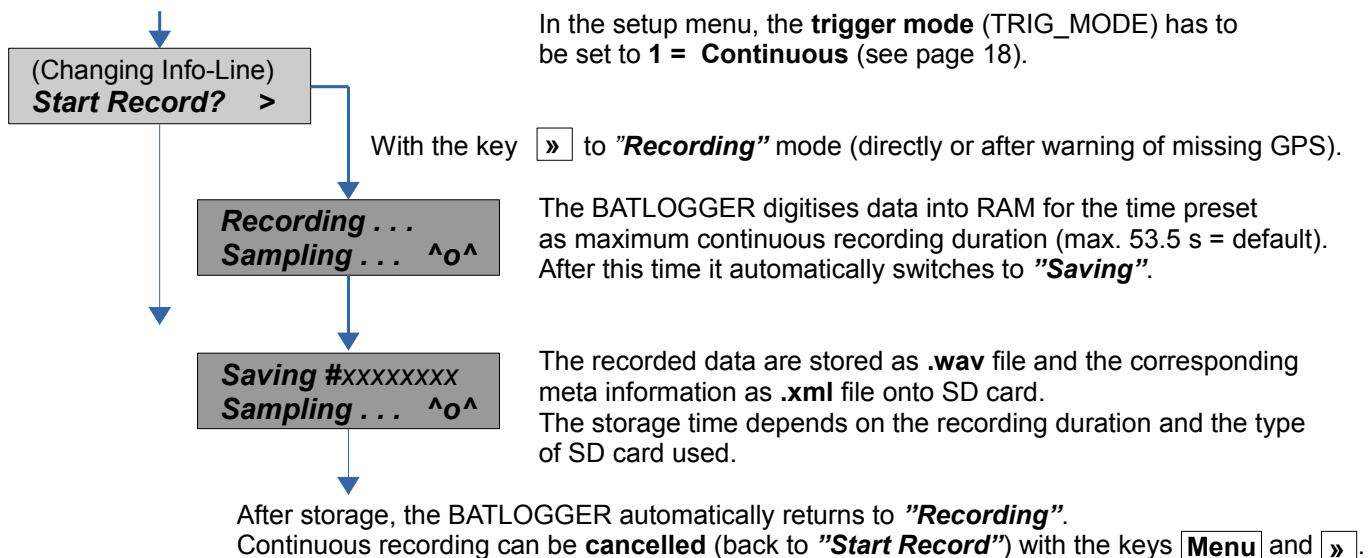

5.3 Crest- and Period – Trigger ("Automatic" recording)

Proceed with key **Menu** in the main menu to **"Start Record"**.

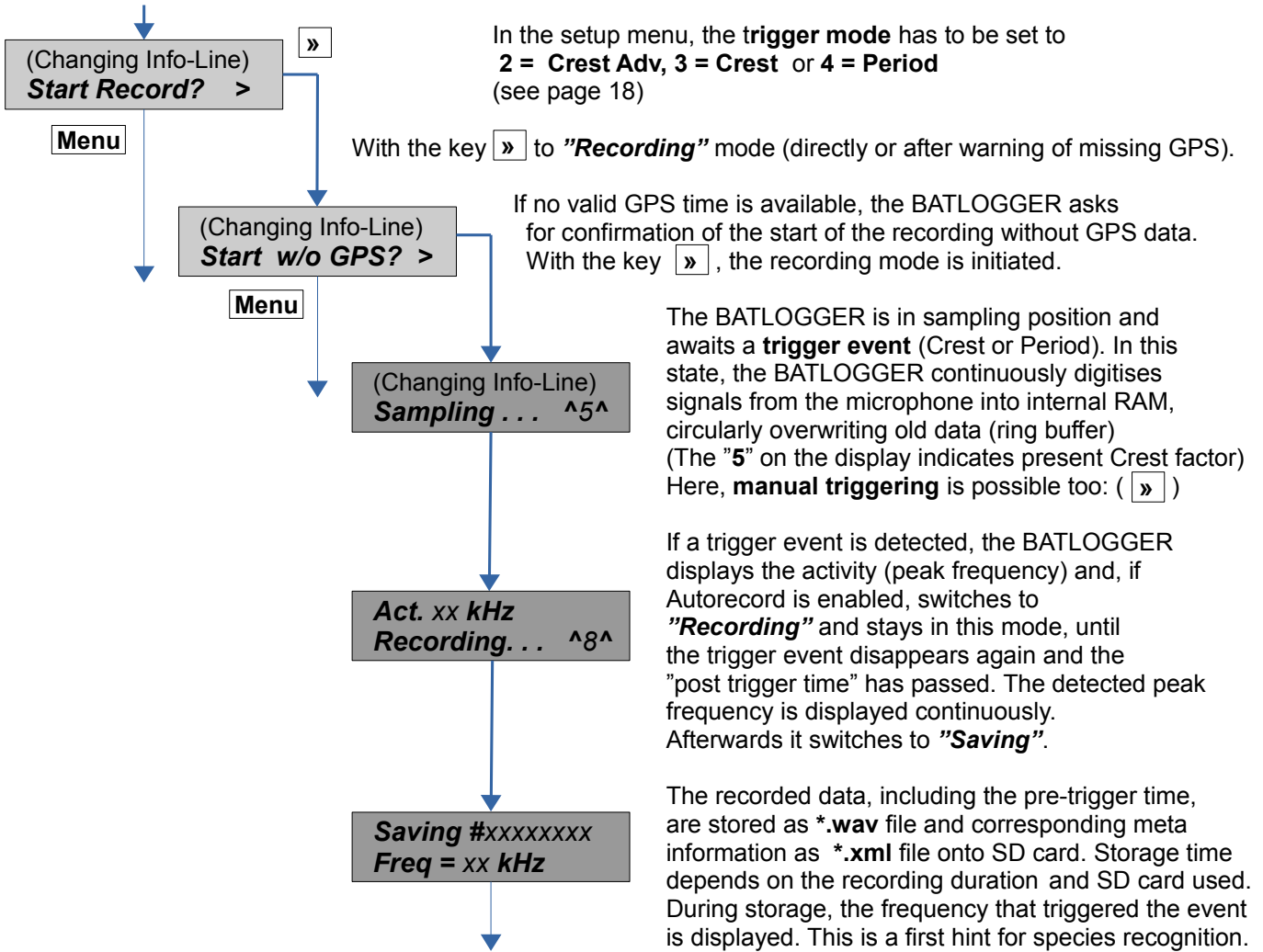

After storage, the BATLOGGER automatically returns to **"Sampling"**. Automatic recording can be **cancelled** (back to **"Start Record"**) with the keys **MENU** and **»**.

5.4 Live monitoring ^A

Is the BATLOGGER in record mode and live monitoring function is enabled (see page 19) the ultrasonic sounds are output live on the speaker or headphones. Here, the bat calls are transformed into audible range after the mixer-principle (heterodyne).

The volume can be adjusted during operation.

There are two methods to use the live monitoring:

- **Automatic**
- The mixer is adapted automatically and continuously to the currently detected frequency of the calling bat.
- Reset frequency: With the **◀** key the mixer frequency can be reset to 48kHz at any time. This is handy to minimize noise or feedback loops that can occur at low frequencies.
- **Manual**
- The mixer frequency can be set manually.

5.5 Menu functions in record mode

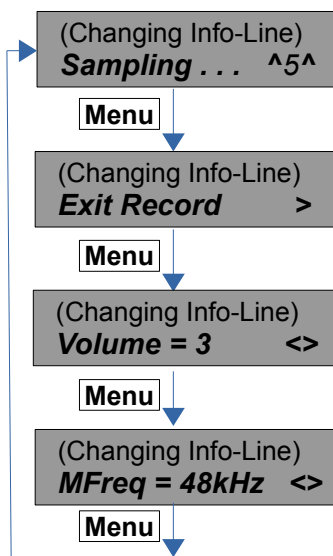

The key **Menu** in the record mode switches between the functions.

Exit the record mode with the key **»**.

With the key **◀** the volume is lowered, with the key **»** raised.
Volume = 0 output is muted.
Only available when live monitoring^A is enabled.

With the key **◀** the frequency is lowered, with the key **»** raised.
Only available when live monitoring^A is enabled and mode is manual.

5.6 Delayed recording (Recording in time windows)

Proceed with key **Menu** in the main menu to **"Start Record"**

If a **time window is defined** in the **"Setup"**, and **at least 1 day is activated**, the BATLOGGER will start directly into **"Sleep"** mode. If preset starting time has already passed, sampling immediately starts.

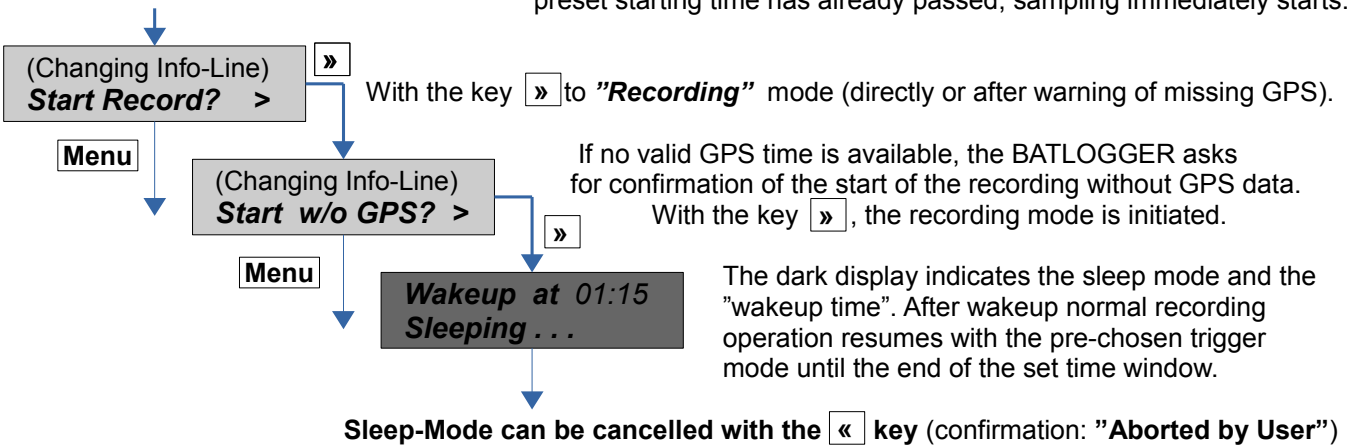

The time windows can be configured flexibly. The times can also be set dynamically by the position of the sun (sunrise and sunset).

Example:

- Nr. Days = 2
- T1 Start = 20:30 (Sunset) T1 Stop = 01:30
- T2 Start = 04:00 T2 Stop = 07:30 (Sunrise + 15min)

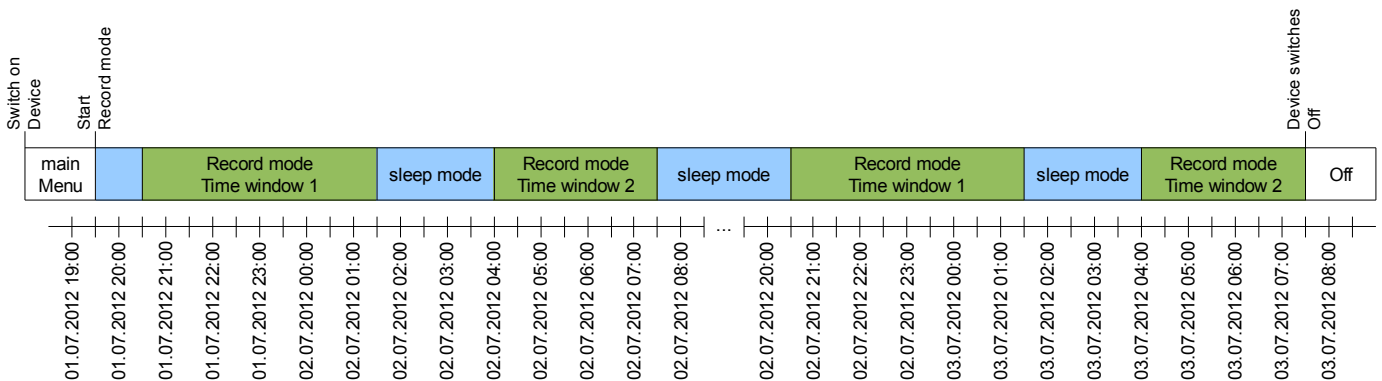

5.7 Interval recording (Recording in intervals)

As with time delayed recording time windows have to be defined and a number of days must be set. When also a recording interval is entered, then the BATLOGGER switches to record mode at the start time, but only for a single recording or max. for one minute.

Then further recordings are blocked for the programmed number of minutes ("RecIntvl" / default = 0 = off). This is followed by another record mode. This interval operation continues to the end of the time window. For this interval operation the various trigger modes can be used.

Example:

- Rec Intervall = 3

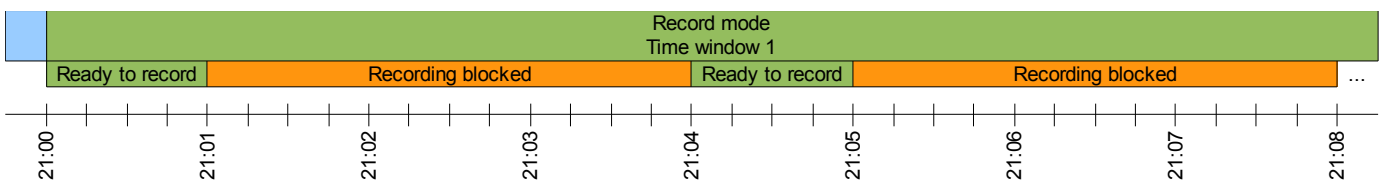

6 Process (Playback, analyse and erase stored wav files)

Proceed with key **Menu** in the main menu to "Process File".

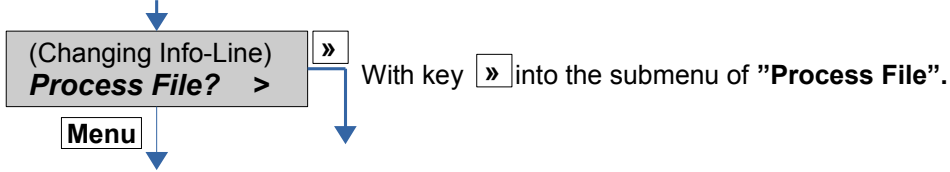

6.1 Choose folder (if used)

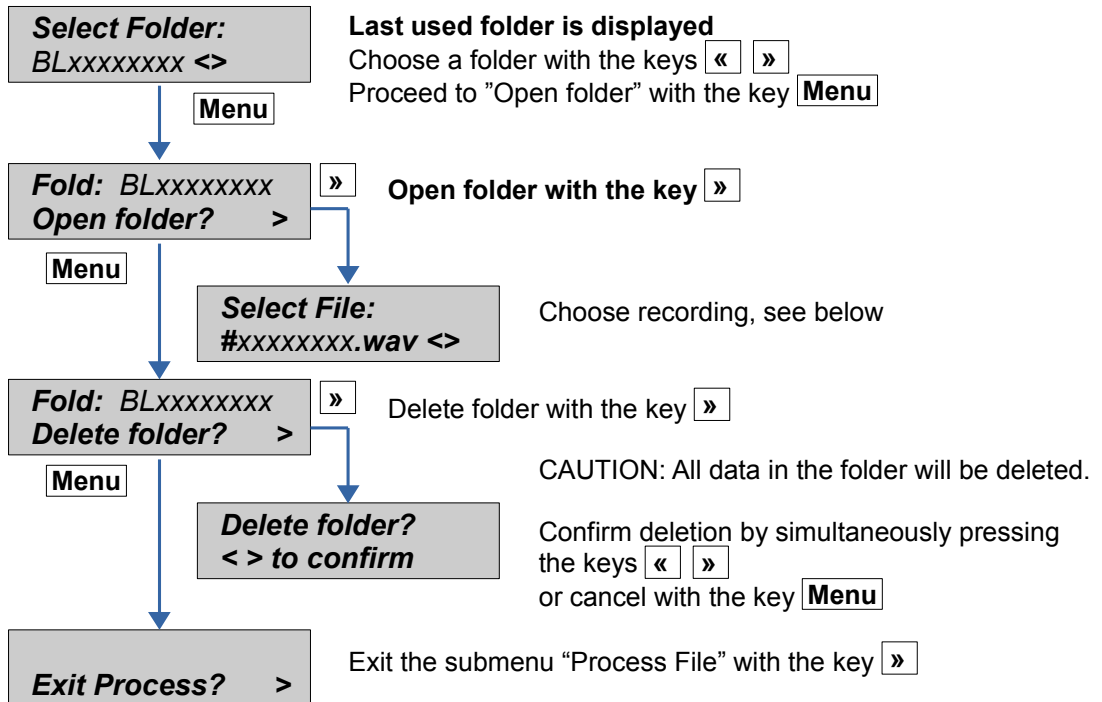

6.2 Choose Recording



The last saved file ist shown.
Selection of a different file with the keys **<<** **>>**.
Proceed to "Play" and "Analyse" with the key **Menu**.

6.3 Play

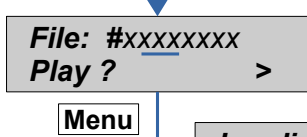

Start playback *the recording* with the key **>**



The file is loaded from the SD card

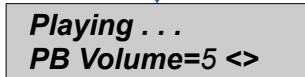

The file is played at the mode preselected in the "Setup".
The volume can be changed with the keys **<<** **>>** (Range: 0 – 9, Default: 5)

6.4 Play All

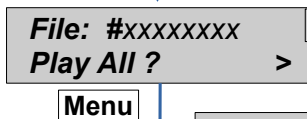

Start playback of all recordings with the key **>>**

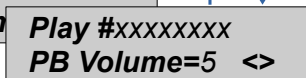
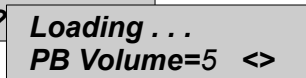
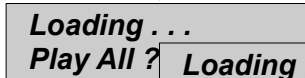

The file is loaded from the SD card and played with the preset mode. After finishing the next (higher #) file is loaded and played. After reaching the highest #, the first file (lowest #), will be read and played and so forth (endless loop). The output volume can be set (see above) and the # of the played file is indicated.

Cancel the play mode with the key **Menu**

6.5 Analyse



"Analyse" the recording with the key **>>**

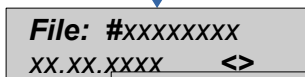

With the keys **<<** **>>** different recording details can be displayed.

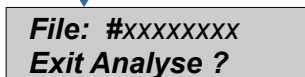
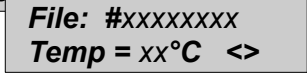
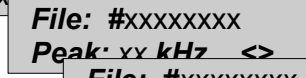
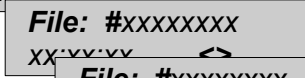

Cancel this submenu with the key **>>**

6.6 Delete (Delete recordings)

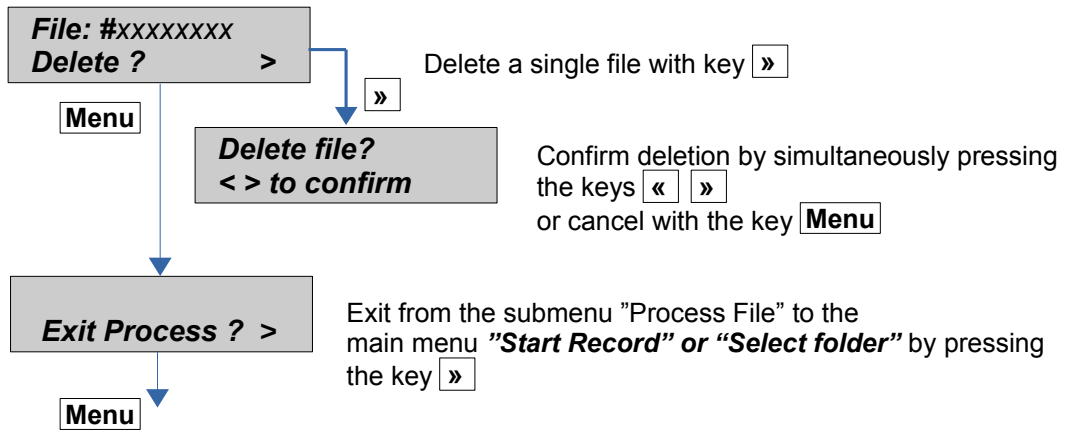

Proceed in the submenu "Process File" with key **Menu** (back to menu point "Select File").

7 Setup (Settings)

Set parameters for

- Recording time windows (delays), triggers
- GPS, backlight, time zone and audio
- SD card and parameter file

7.1 Operation

Proceed with key **Menu** in the main menu to "Setup?"

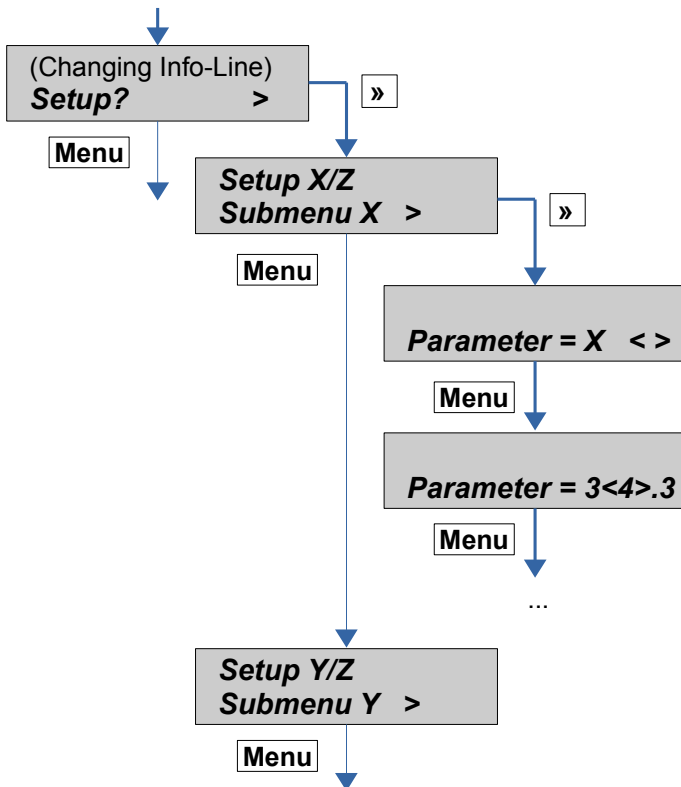

With the key **»** into the submenu of "Setup".

With the key **»** into the submenu or with the key **Menu** to the next menu item or with the key **«** to the last menu item.

With the keys **«** **»** value can be changed.

With the key **Menu** to the next parameter.

For larger number values (e.g. coordinates) single digits can be increased/decreased with the **«** **»** keys. Go to the next digit with the key **Menu**. Complete the entry with „←“.

To exit the setup menu the last menu item („Exit Setup“) must be selected.

7.2 Setup-Menu

<i>Menu</i>	<i>Description</i>	<i>Default</i>
Setup 1/7 Delay Record	Timing (delay) of the recordings (Program 1 or 2 time slots per day for a programmed number of days)	
Nr. Days	Enter the number of days (0..999) on which the time windows (one or both) are performed. 0 = time control (delay) disabled Example: 30 For a maximum of 30 days, recording is performed during the configured time slot (see below)	0
T1 Start Mode	Mode 1. start time 0 = Fixed: Fixed time 1 = Sunset: Time of sunset at location of LOC_LAT/LOC_LON of the respective day 2 = Sunrise: Time of sunrise at location of LOC_LAT/LOC_LON of the respective day	0
T1 Start	1. start time Depending on the mode: time or difference (in 15 minute steps) Example: Fixed 20:30 Start 1. time window at 20:30	00:00
T1 Stop Mode	Mode 1. stop time 0 = Fixed: Fixed time 1 = Sunset: Time of sunset at location of LOC_LAT/LOC_LON of the respective day 2 = Sunrise: Time of sunrise at location of LOC_LAT/LOC_LON of the respective day	0
T1 Stop	1. stop time Depending on the mode: time or difference (in 15 minute steps) Example: Fixed 01:00 Stop 1. time window at 01:00	00:00
T2 Start Mode	Mode 2. start time 0 = Fixed: Fixed time	0

	<p>1 = Sunset: Time of sunset at location of LOC_LAT/LOC_LON of the respective day</p> <p>2 = Sunrise: Time of sunrise at location of LOC_LAT/LOC_LON of the respective day</p>	
T2 Start	<p>2. start time Depending on the mode: time or difference (in 15 minute steps) Fixed 00:00 = 2. time slot disabled</p> <p>Example: Sunrise -02:30 Start 2. time window 2:30h before sunrise</p>	00:00
T2 Stop Mode	<p>Mode 2. stop time</p> <p>0 = Fixed: Fixed time</p> <p>1 = Sunset: Time of sunset at location of LOC_LAT/LOC_LON of the respective day</p> <p>2 = Sunrise: Time of sunrise at location of LOC_LAT/LOC_LON of the respective day</p>	0
T2 Stop	<p>2. stop time Depending on the mode: time or difference (in 15 minute steps) Fixed 00:00 = 2. time slot disabled</p> <p>Example: Sunrise +00:30 Stop 2. time window 30min after sunrise</p>	00:00
Rec Intervall	<p>Interval time between single recordings (in one minute steps)</p> <p>Example: 3 After a recording at least 3 minutes no new recording is started (triggered)</p>	0

Setup 2/7 Trigger			Trigger settings Set the trigger mode, that is how a recording is started	
	TRIG_MODE:		<i>Choose trigger mode:</i> 0 = Manual: start and stop recording need manual key input (autom. stop after "MANTRIG MAXTIME") 1 = Continuous: continuous recording of blocks of default 53 seconds duration (interrupt for storage). 2 = Crest Adv: automatic triggering with Crest factor, enhanced call detection and reduce noise sensitivity (manual triggering possible to override automatism) 3 = Crest: automatic triggering with Crest factor (manual triggering possible to override automatism) 4 = Period: automatic triggering with Period algorithm (manual triggering possible to override automatism)	2
	TRIG_AUTOREC		0 = Manual: A trigger event does not start recording. The recording must be started and stopped manually, but the trigger frequency is displayed. 1 = Auto: A trigger event automatically starts the recording and recording automatically stops when trigger conditions are no longer met.	1
	TRIG_MODE: Crest Adv	Min. Crest	Minimal Crest factor as trigger condition Lower values trigger easier	7
		Min. F	Minimal frequency for trigger condition in kHz	15
		Max. F	Maximal frequency for trigger condition in kHz	155
	TRIG_MODE: Crest	Min. Crest	Minimal Crest factor as trigger condition Lower values trigger easier	6
		Min. RMS	Factor for minimal effective value as trigger condition Lower values trigger easier	2
		Min. Peak	Factor for minimal amplitude as trigger condition Lower values trigger easier	2
		HP	Factor for the lowest frequency, that still may elicit a trigger event (Factor times 1,22 kHz)	6
TRIG_MODE: Period	ProdVal	Period-Trigger: ProdVal Higher values improve triggering at low frequencies, but also insects, and vice versa.	8	
	DivVal	Period-Trigger: DivVal Higher values improve triggering at low frequencies, but also insects, and vice versa.	20	

Setup 3/7 Audio		Audio settings	
	Volume	Headphones/Speaker [^] -Volume 0 = mute 9 = very loud ATTENTION: Too high volume can cause hearing loss, particularly using the headphones	5
	Monitoring	Live monitoring (mixer output) [^] 0 = Off: Live monitoring disabled 1 = On Auto: Live monitoring enabled, frequency is set automatically 2 = On Manual: Live monitoring enabled, frequency must be set manually	1
	PB Mode	Playback mode 0 = Pitch: playback slowed down with PB Speed factor 1 = Mixer: playback mixed with peak frequency of the recording	1
	PB Speed	Playback speed 1: real-time 2: half speed etc. Example: 10 The recordings are played slowed down 10 times (time expansion and frequency division). Thus the ultrasonic sounds are audible (e.g. 45 kHz -> 4.5 kHz) The real-time playback enables the output of the original ultrasonic sounds. This can be useful for demonstration purpose for example. Pay attention to connect a speaker with appropriate ultrasound capability.	10
	Test Microphone	Record the current spectrum and write it to the log file	

Setup 4/7 Location / GPS	Position and GPS settings		
	Show Status	<p>Displays the current status of GPS reception and information about the current location and the received satellites. Switch the displayed information with the keys « » or exit with the key Menu.</p> <ul style="list-style-type: none"> • Fix status, approx. accuracy in meters (radius), actual position • Hight above sea level, speed and heading • HDOP and VDOP • Sunset and sunrise at actual location at today's date • Satellites in view, SNR and PRN of the five strongest satellites • Distance and direction to position of LOC_LAT/LOC_LON 	
	GPS Mode	<p>Set position determination mode</p> <p>0 = Off: position determination disabled 1 = On: position determination enabled 2 = On w/GPX: position determination and track recording (GPX) enabled 3 = Off w/Loc: position determination disabled, position of LOC_LAT/LOC_LON is stored as recording position into the XML file</p> <p>Example: 0 GPS off for the lowest possible power consumption or because reception is not possible, such as in caves.</p>	1
	Coord.Fmt	<p>Coordinates display format to display current location</p> <p>0 = WGS84: (e.g.. 47.052804 / 8.257801) 1 = CH1903: (e.g.. 662240 / 211632)</p>	0
	TZ	<p>Set time zone Deviation to UTC in hours</p> <p>Example: +2 Daylight savings time in Zurich (CH)</p>	+2
	GPS_INTERVAL	<p>Interval of position determination in seconds</p> <p>Lower values = more frequent position determination, higher power consumption Higher values = less frequent position determination, lower power consumption</p> <p>Note: While recording, the position determination is paused for performance reasons.</p>	10
	Set manual location	<p>Enter manual location (coordinates) This location is used:</p>	

		<ul style="list-style-type: none"> • To calculate sunset and sunrise • As recording position in GPS mode 3 (Off w/Loc) • To calculate distance and direction in the GPS status view 	
	LOC_LAT	Latitude, in WGS84 or CH1903 (dep. Coord. Fmt)	47.2
	LOC_LON	Longitude, in WGS84 or CH1903 (dep. Coord. Fmt)	7.4
	Set current location	The coordinates of the current position are stored as manual location	

Setup 5/7 SD Card		SD card setup	
	Folder_MODE	<p>Store recording in folders</p> <p>0 = None: No folders used, all data is stored in the root folder of the SD card</p> <p>1 = Daily: Use a new folder daily (12:00 – 12:00): Blyyyyymmdd</p> <p>2 = Weekly: Use a new folder weekly (Mo 12:00 – Mo 12:00): BlyyyWww</p> <p>3 = Monthly: Use a new folder monthly (1. 12:00 – 1. 12:00): Blyyyymm</p> <p>Example: 1</p> <p>Recordings (WAV, XML, GPX, KMZ) are stored into a separate folder each night</p> <p>Folder “BL20130802” contains data of the night from 2. to the 3. August 2013</p> <p>Folder “BL20130803” contains data of the night from 3. to the 4. August 2013</p> <p>etc.</p> <p>The folder is changed each day at noon (12:00)</p>	0
	STATUS_MODE	<p>BLWiFi status</p> <p>0 = Off: Disabled</p> <p>1 = On: Enabled, BLWiFi can display the actual state if a connection is established</p>	0
	Write BATPARS	Write the current settings to the BATPARS.XML file	
	Delete BATPARS	Delete the BATPARS.XML file from the SD card	
	Format SD Card	<p>Format the SD card</p> <p>CAUTION: All data on the SD card will be deleted. Make sure that you have made a backup.</p>	
	Test SD Card		

Setup 6/7 Miscellaneous			Various settings	
	Set Date/Time		Set date and time	
		TIMEMODE	0 = Manual: Date and time can be set manually (as UTC) 1 = Auto GPS: Date and time is set automatically on GPS reception	1
	Backl.Mode		Set the display backlight 0 = Off: Backlight off during recording 1 = Dimmed: Backlight dimmed during recording 2 = Bright: Backlight bright during recording (except in recording mode, the display backlight is always bright; in sleep mode the light is always off)	1
	Load Defaults		Set settings back to factory defaults	
Setup 7/7 Exit Setup			Exit Setup menu and save changes	
	Save to BATPARS		Write settings to BATPARS.XML file and exit Setup menu	
	Save to int.Mem		Write settings to internal memory and exit Setup menu If the BATPARS.XML file exists on the SD card, those settings will be loaded on the next start of the BATLOGGER.	
	Discard changes		Discard changes and exit Setup menu	

8 Recordings and Files

8.1 The audio data file "xxxxxxx.wav" (e.g. 10160435.wav)

After completion of recording into internal RAM, the stored data is written as standard audio WAVE file onto the inserted SD card with the file name "xxxxxxx.wav". (e.g. 10160435.wav)

The first four digits identify the serial number of the BATLOGGER and the following four digits exhibit the consecutive number of the recorded files on the inserted SD card.

The above example therefore identifies the 435th recording on this SD card of the BATLOGGER with the serial number 1016.

The *.wav file contains all the uncompressed raw measurement values of the analog to digital converter and a "header", which is specific to the wave format. This "header" contains, amongst other information, the sampling rate of the digitiser.

Concurrent with these recorded wave data, a file containing meta information about the recording (see below) is saved to SD card with the name *.xml (in our example 10160435.xml).

The recordings can optionally be stored into subfolders (daily, weekly, monthly). See also on page 19.

The standard *.wav files can be read and opened with general audio software or bat specific sound analysis programs. It may be displayed as time signal or spectrogram. The latter offers best possibilities to identify species.

Elekon AG offers a specific analysis software for Windows PCs: **BatExplorer**. It can be found on the included SD card or can be downloaded from www.batlogger.ch.

[WSL](http://www.wsl.ch) offers **BatScope**, a Mac software tool for management and preview of recorded data, which will eventually be extended to bat species identification: see <http://www.wsl.ch/fe/biodiversitaet/produkte/batscope/> or bats@wsl.ch

8.2 Meta data file "xxxxxxx.xml" (Bsp. 10160435.xml)

With every saved "xxxxxxx.wav" audio file, an additional information file "xxxxxxx.xml" is saved, following the same numbering convention, and containing various meta information on recording time, date, location, temperature and the BATLOGGER parameter settings.

Example of the content of an *.xml meta information file:

<pre><BatRecord> <Firmware>2.0</Firmware> <SN>1016</SN> <Filename>10160435.wav</Filename> <DateTime>28.04.2010 21:31:29</DateTime> <Duration>2 Sec</Duration> <Samplerate>312500 Hz</Samplerate> <Temperature>26 C</Temperature> <BattVoltage>3.92 V</BattVoltage> <GPS> <Valid>yes</Valid> <Position>47.056358 8.251432</Position> <Altitude>475.299988 m</Altitude> <CH1903>661752/212022</CH1903> <HDOP>1.140000</HDOP> GPSTimestamp>19:31:20+2h</GPSTimestamp> <GPSAge>9 Sec</GPSAge> </GPS> (In case of invalid or missing GPS information, the above section will just contain: <Valid>never</Valid>) <Trigger> <TRIG_MODE>Crest</TRIG_MODE> <Version>V1.0</Version> <Event>AutoTriggerd</Event> <PRETRIG_TIME_MS>500</PRETRIG_TIME_MS> <POSTTRIG_TIME_MS>1000</POSTTRIG_TIME_MS> <TRIG_PAR0>6</TRIG_PAR0> <TRIG_PAR1>2</TRIG_PAR1> <TRIG_PAR2>2</TRIG_PAR2> <TRIG_PAR3>12</TRIG_PAR3> <TrigValue0>6</TrigValue0> <TrigValue1>40</TrigValue1> <TrigValue2>263</TrigValue2> <TrigValue3>44</TrigValue3> </Trigger> </BatRecord></pre>	<p>The .xml info file contains the following information:</p> <p><i>The firmware of the BATLOGGER was version 2.0</i></p> <p><i>The BATLOGGER's number was 1016 (Serial Number)</i></p> <p><i>The accompanying WAVE file is "10160435.wav"</i></p> <p><i>The recording happened on April, 28. 2010 at 21:31:29</i></p> <p><i>The recording duration is 2 seconds</i></p> <p><i>The sampling rate was 312500 samples per second</i></p> <p><i>The temperature when recording was 26° C</i></p> <p><i>The battery voltage amounted to 3.92 V</i></p> <p><i>The GPS information was valid</i></p> <p><i>Lat.- & longitude of the rec. position in degrees (WGS84)</i></p> <p><i>Elevation above sea level was 475.3 m</i></p> <p><i>The Swiss coordinates are 661752 / 212022 m (CH1903)</i></p> <p><i>The horizontal precision amounts to 1.14 (lower=better)</i></p> <p><i>GPS time was 19:31:20 UTC + 2 h. for local time</i></p> <p><i>The GPS "age" was 9 seconds (last positional reading)</i></p> <p><i>The trigger mode was set to "Crest"</i></p> <p><i>The version of the triggering algorithm was V1.0</i></p> <p><i>The triggering was automatic, thus with the Crest routine</i></p> <p><i>Before the first trigger occurred, 0.5 s were recorded</i></p> <p><i>After the last trigger event, 1 s was additionally recorded</i></p> <p><i>The parameter "min.Crest" was set to 6</i></p> <p><i>The parameter "min.RMS" was set to 2</i></p> <p><i>The parameter "min.Peak" was set to 2</i></p> <p><i>Trigger cutoff freq. was set to > than 12x1.22kHz=15 kHz</i></p> <p><i>Triggering Value of parameter TRIG_PAR0</i></p> <p><i>Triggering Value of parameter TRIG_PAR1</i></p> <p><i>Triggering Value of parameter TRIG_PAR2</i></p> <p><i>Triggering Value of parameter TRIG_PAR3</i></p>
---	--

8.3 Parameter file "BATPARS.xml"

With any computer, the default values and settings of the BATLOGGER can be predefined and written to the parameter file. The file is stored on the SD card with the name "BatPars.xml". When the BATLOGGER is starting up, the file is read from SD card and the corresponding settings activated. Settings, that are changed interactively on the BATLOGGER are also saved to the "BATPARS.xml" file:

Exit Setup > Save to BATPARS

Optional changes can be applied until the next on/off cycle of the BATLOGGER only:

Exit Setup > Save to internal Memory

When formatting an SD card, the file "BATPARS .xml" will be read from SD card into the internal memory before formatting, and written back to SD card after formatting has finished.

Without the file "BATPARS .xml" on the SD card, the BATLOGGER starts with its internal "CMOS" parameters, which correspond to the values last set. When starting the BATLOGGERS up after a firmware update, the default parameters will be loaded.

To change the parameters conveniently on the computer the BATPARS Editor software can be executed and the "BATPARS.xml" file from the SD card can be opened. The parameters can now be adjusted to own preferences or factory settings can be restored. See also page 8.

The parameters can also be changed with a text editor software. The following example of a "BATPARS .xml" file shows the **default values**:

```

|
<BatPars>
<SETUP_DISABLED>0</SETUP_DISABLED>
<TIMEZONE>2</TIMEZONE>
<TIMEMODE>1</TIMEMODE>
<BACKLIGHT_MODE>1</BACKLIGHT_MODE>
<FOLDER_MODE>0</FOLDER_MODE>
<STATUS_MODE>0</STATUS_MODE>
<GPS_MODE>1</GPS_MODE>
<GPS_FORMAT>1</GPS_FORMAT>
<GPS_INTERVAL>10</GPS_INTERVAL>
<LOC_LAT>472000</LOC_LAT>
<LOC_LON>74000</LOC_LON>
<PLAYBACK_SPEED>10</PLAYBACK_SPEED>
<PLAYBACK_VOL>5</PLAYBACK_VOL>
<PLAYBACK_MODE>1</PLAYBACK_MODE>
<MONITORING>1</MONITORING>
<PRETRIG_TIME_MS>500</PRETRIG_TIME_MS>
<POSTTRIG_TIME_MS>1000</POSTTRIG_TIME_MS>
<AUTOTRIG_MAXTIME_MS>20000</AUTOTRIG_MAXTIME_MS>
<MANTRIG_MAXTIME_MS>10000</MANTRIG_MAXTIME_MS>
<TRIG_MODE>2</TRIG_MODE>
<TRIG_AUTOREC>1</TRIG_AUTOREC>
<TRIG_NRBLOCKS>2</TRIG_NRBLOCKS>
<TRIG_PAR0>6</TRIG_PAR0>
<TRIG_PAR1>2</TRIG_PAR1>
<TRIG_PAR2>2</TRIG_PAR2>
<TRIG_PAR3>6</TRIG_PAR3>
<TRIG_PAR4>8</TRIG_PAR4>
<TRIG_PAR5>20</TRIG_PAR5>
<TRIG_PAR6>7</TRIG_PAR6>
<TRIG_PAR7>15</TRIG_PAR7>
<TRIG_PAR8>155</TRIG_PAR8>
<RECDLY_NRDAYS>0</RECDLY_NRDAYS>
<RECDLY_T1STARTMODE>0</RECDLY_T1STARTMODE>
<RECDLY_T1STOPMODE>0</RECDLY_T1STOPMODE>
<RECDLY_T2STARTMODE>0</RECDLY_T2STARTMODE>
<RECDLY_T2STOPMODE>0</RECDLY_T2STOPMODE>
<RECDLY_T1START>00:00</RECDLY_T1START>
<RECDLY_T1STOP>00:00</RECDLY_T1STOP>
<RECDLY_T2START>00:00</RECDLY_T2START>
<RECDLY_T2STOP>00:00</RECDLY_T2STOP>
<RECINTVL_MIN>0</RECINTVL_MIN>
</BatPars>

```

** Setup - Menu – Locking (1=locked menu)*
Time zone GMT + 2h
Set time 0=Manuell, 1=via GPS
Mode of display backlight operation
Folders 0=none, 1=daily, 2=weekly, 3=monthly
Statusfile 0=off, 1=on
PS 0=off, 1=on, 2=on with GPX, 3=off with location
PS - coordinates – display format
Refresh positon every X s
Latitude of manual location 1/10000°
Longitude of manual location 1/10000°
Frequency divider rate (playback speed)
Loudness at the headphone jack/speaker^A
Playback mode 0=Pitch, 1=Mixer
Live monitoring^A 0=off, 1=on auto, 2=on manual
** Recording time before the first trigger in ms*
** Recording time after the last trigger in ms*
** Max. recording time per automatic trigger in ms*
** Max. recording time per manual trigger in ms*
Trigger mode (Man./Cont./CrestAdv/Crest/Period)
Autostart recording on trigger event
** Nr. of FFT blocks for check of valid trigger event.*
Crest: min. Crest factor for triggering
Crest: min. RMS value for triggering
Crest: min. peak value for triggering
Crest: min. frequency for triggering (x 1,22 kHz)
*Period: MN*SD of periods in test interval (ProdVal)*
*Period: SD/MN of periods (*100) in test int. (DivVal)*
Crest Adv: min. Crest factor for triggering
Crest Adv: min. frequency for triggering in kHz
Crest Adv: max. frequency for triggering in kHz
Nr. of days for time windowed recordings
Time window mode:
 0=fixed
 1=sunset
 2=sunrise
Start time 1, start of 1st time window
Stop time 1, end of 1st time window
Start time 2, start of 2nd time window
Stop time 2, end of 2nd time window
Recording interval in minutes

* identifies parameters, that can only be set by changing the values in the file "BatPars.xml". They are not "visible" or accessible through the setup menu of the BATLOGGER!

8.4 Log file "BATREC.log"

When in use, the BATLOGGER automatically writes a log file "BATREC.log" in text format to the SD card. Every text line is preceded by the serial number (SN) of the BATLOGGER writing the log. When changing the SD card to another logger, or removing it and re-inserting it again, the log file will be extended and new log information appended to the "BATREC.log" file. Deleting WAVE files through the menu of the BATLOGGER does not affect the "BATREC.log" file.

However, formatting the SD card will also erase the "BATREC.log" file!

In the file "BATREC.log", all activities of the BATLOGGER are listed chronologically.

Events like starting up or shutting down the BATLOGGER are logged accurate to the minute, while logging of the normal recording activity only happens every 15 minutes.

SN1021 22.07.2009 21:37 - power on	<i>BATLOGGER #1021 was switched on</i>
SN1021 22.07.2009 21:37 - record mode started	<i>Recording started</i>
SN1021 22.07.2009 21:37 - record mode stopped by user	<i>Recording cancelled by user</i>
SN1021 22.07.2009 21:42 - record mode started	<i>Recording started again</i>
SN1021 22.07.2009 23:45 - listening T = 21 VB = 3.912	<i>BATLOGGER is in recording mode and waiting</i>
SN1021 23.07.2009 00:00 - listening T = 20 VB = 3.908	<i>for a triggering event, with indication of</i>
SN1021 23.07.2009 00:15 - listening T = 19 VB = 3.905	<i>temperature (21°C) and battery voltage (3.912V)</i>
SN1021 23.07.2009 00:30 - listening T = 19 VB = 3.905	
SN1021 23.07.2009 00:45 - sleeping	<i>The BATLOGGER went into sleep mode</i>
SN1021 23.07.2009 02:45? - wakeup time reached	<i>Automatic wake-up after sleep mode</i>
SN1021 23.07.2009 02:45? - listening T = 17 VB = 3.891	<i>?: no valid GPS signal found (time is taken</i>
SN1021 23.07.2009 03:00 - listening T = 17 VB = 3.886	<i>from internal clock in this case)</i>
SN1021 23.07.2009 03:15 - listening T = 16 VB = 3.882	
SN1021 23.07.2009 03:30 - listening T = 16 VB = 3.877	
SN1021 23.07.2009 03:45 - listening T = 16 VB = 3.871	
SN1021 23.07.2009 04:00 - listening T = 15 VB = 3.865	
SN1021 23.07.2009 04:15 - listening T = 15 VB = 3.860	
SN1021 23.07.2009 04:30 - listening T = 15 VB = 3.856	
SN1021 23.07.2009 04:45 - listening T = 15 VB = 3.852	
SN1021 23.07.2009 05:00 - listening T = 15 VB = 3.847	
SN1021 23.07.2009 05:15 - listening T = 15 VB = 3.843	
SN1021 23.07.2009 05:30 - listening T = 16 VB = 3.838	
SN1021 23.07.2009 05:45 - listening T = 16 VB = 3.833	
SN1021 23.07.2009 05:55 - shutdown	<i>The BATLOGGER was shut down</i>

Example of a quick startup of the logger

with the manual triggering and cancelling of a recording:

```
SN1021 25.07.2009 19:47? - power on
SN1021 25.07.2009 19:47? - record mode started
SN1021 25.07.2009 19:47? - record mode stopped by user
SN1021 25.07.2009 19:47? - shutdown
```

Example of another message that may appear:

```
SN1021 25.07.2009 19:47? - microphone removed
```

In interval mode, the pausing will be indicated with the following entry:

```
SN1021 27.07.2009 02:45 - snooze
```

8.5 Google-Earth file "route.kml"

When in use, the BATLOGGER automatically stores a Google-Earth file with the name "route.kml" onto the SD card, which will be extended with every additional recording. If the SD card is used repeatedly (eject, reinsert) the "route.kml" will not be erased, but also extended.

Deleting WAVE files through the menu of the BATLOGGER does not affect the "route.kml" file.

However, formatting the SD card will also erase the "route.kml" file!

In the file "route.kml", all recording positions of the BATLOGGER with "valid" GPS data are listed chronologically.

8.6 Track file "xxxxxxx.gpx" (e.g. 10160435.gpx)

Optionally, the track travelled can be recorded. This requires that the GPS mode is set to 2.

In this mode a GPX file is with the current record number created (e.g. 10160435.gpx) and then the current GPS position is recorded continuously. The sampling rate can be set using the „GPS_INTERVAL“ parameter.

The track recording is stopped when the recording mode is exited. When recording mode is restarted a new GPX file is created, or, if no audio recording was made since last start, the existing GPX file is continued.

The GPX file contains the route taken as so-called track. It is based on the XML standard and can be opened with Google Earth for example or most major GIS software.

9 Technical specifications

Dimension		Default values	Select / setup via keys	Select / setup via parameter file on SD card			
Size (B x H x T)	80 x 155 x 38 mm						
Weight	370g						
Size of case (B x H x T)	330 x 280 x 75 mm						
Power							
Power supply	3.7V 4600 mAh Li-Ion battery (internal)						
Power consumption when recording	approx. 230 mA						
Power consumption in sleep mode	approx. 10 mA						
Operating time (recording)	approx. 18 h per battery charge						
Operating time (sleep mode)	approx. 400 h per battery charge						
Charger / Charging							
Charger (included)	Wall power supply 12 VDC (100-240 VAC)						
Charging socket (voltage, capacity)	9 V DC to 15 V DC, min. 5 W						
Battery charge	I- /U-charge with 750 mA / 4.2 V						
Charging duration	approx. 7 h (full charge)						
Recording ultrasound							
Sampling rate	312.5 kHz						
Amplitude resolution	16 bits (ADC)						
Sensitivity range	10 – 150 kHz						
Trigger modes	Manual, Continuous, Crest Adv, Crest, Period				Crest Adv	X	X
Frequency trigger (Crest) 4 parameters	Crestfaktor / RMS / Peakwert / HochPass				6 / 2 / 2 / 6	X	X
Frequency trigger (Crest Adv) 3 param.	Crestfaktor / min. F / max. F				7 / 15 / 155	X	X
Period trigger 2 parameters	mnPer / sdPer				8 / 20	X	X
Rec. duration after trigger (post-trigger)	0 – 53.5 sec @ 312.5 kHz SR				1 s		X
Rec. duration before trigger (pre-trigger)	0 – 53.5 sec @ 312.5 kHz SR				0.5 s		X
Rec. duration with manual trigger	0 – 53.5 sec @ 312.5 kHz SR				10 s		X
Rec. duration with continuous trigger	0 – 53.5 sec @ 312.5 kHz SR				20 s		X
Two time windows programmable per day for recordings (time of the day)					None set	X	X
Recording in intervals in time windows with preset pause times (number of minutes)					0 = no int.	X	X
Additional measurements (Position, time, temperature)							
Position	GPS (coordinates / elev. meters .a.s.l / time) GPS reception GLONASS reception ^A						
GPS mode	on / off				on	X	X
Temperature reading	Resolution 1°C (internal / plug-in mic.)						
Audio							
Microphone	Electret microphone						
Speaker ^A	Piezo, 90dB						
Audio output	Headphone (3.5 mm mini jack/ 2 ch. mono)						
Data storage							
Storage media	SD/SDHC/SDXC card (SD 2.0) max. 128 GB FAT32 formatted						
Length of single "calls" sequences	0 – 53.5 sec per file @ 312.5 kHz SR	max 53.5s					
Recording per GigaByte	approx. 25 minutes (real time)						
Analysis							
Data transfer from SD card							
File formats	*.wav and *.xml						
Time expansion	Factor 1 – 20 (pitch)	10	X	X			

A Only certain models, see also 2.2 Device variants



Made in Switzerland
March 2014

© 2014 Elekon AG, All rights reserved. Elekon, the Elekon logo and BATLOGGER are trademarks and / or registered trademarks of Elekon AG. Other brand and product names are trademarks or registered trademarks of their respective owners. Information may be changed without prior notice.

elekon

Elekon AG
Cheerstrasse 16
CH-6014 Luzern

www.batlogger.ch