

---

# Product Specifications

Name: DMX-SPI Decoder



## Summarization

The DMX-SPI decoder adopts the advanced micro control unit, it receives standard DMX-512 digital control signal that is widely used in the international and transforms it into SPI signal to drive LED, it supports 10 kinds of different model of lights, at the same time the port of DMX signal has lightning protection measures; you could connect the DMX decoder with DMX digital console to achieve dimming or various changes in procedures. Not connected with DMX console, you can choose select the built-in 35 kinds of default patterns through the modle button, the default points is 1024.

## Technical Parameters

### Controller

- Working temperature: -20-60 °C
- Input voltage: DC5-24V
- Output: SPI signal (DATA, CLK)
- External dimension: L175 x W53 x H27 (mm)
- Packing size: L180 x W58 x H55 (mm)
- Net weight: 256.2g
- Gross weight: 292.6g
- Max output:480W

## External Dimension

### Controller External Dimension:

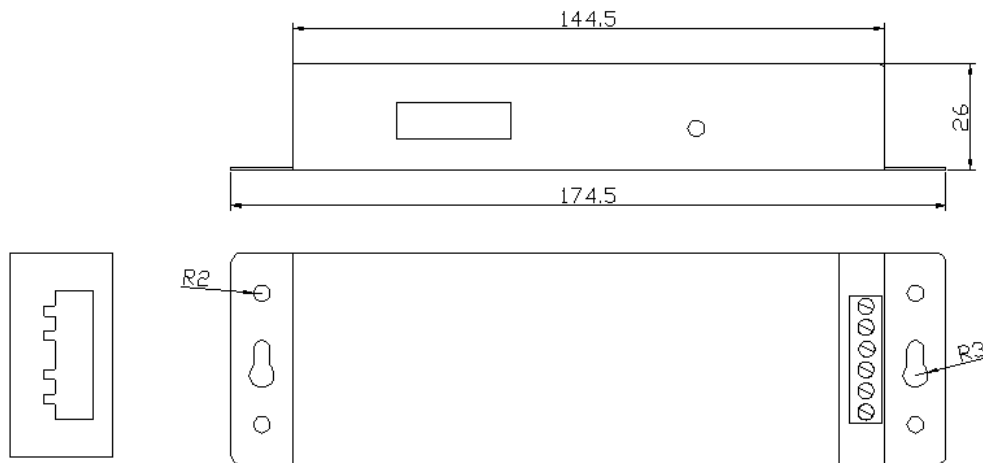

## Interface Specification

Interface of DMX signal adopts the 6PIN green terminal interface, wiring is as follows:

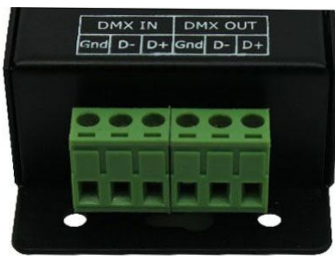

**DMX IN:** input interface of DMX signal, D+ should be connected with positive of signal, D- connected with negative of signal, Gnd connected with ground.

**DMX OUT:** output interface of DMX signal, D+ should be connected with positive of signal, D- connected with negative of signal, Gnd connected with ground.

Power and load output adopts the 6PIN green terminal, wiring is as follows:

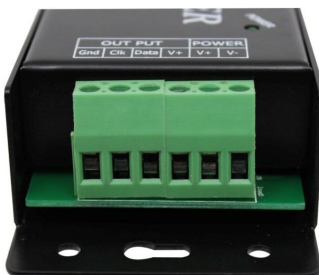

**POWER:** input interface of power, V+ should be connected with positive of power, V- connected with

negative of power, the range of supply voltage is DC5-24V

**OUT PUT:** load output interface, V+ should be connected with the positive of light, GND connected with negative, DATA connected with data interface of light, CLK connected with clock interface of light.

## Direction for use

### 1. parameters settings of decoder

You can modify the light type that decoder supports through the DIP switch. The decoder can support 10 kinds of SPI strips in market. As follows:

| Number | Model   | Signal line |
|--------|---------|-------------|
| 1      | LPD6803 | DATA, CLK   |
| 2      | TM1803  | DATA        |
| 3      | TM1809  | DATA        |
| 4      | TM1812  | DATA        |
| 5      | UCS1903 | DATA        |
| 6      | WS2811  | DATA        |
| 7      | WS2801  | DATA, CLK   |
| 8      | TLS3001 | DATA        |
| 9      | TLS3008 | DATA        |
| 10     | P9813   | DATA, CLK   |

If there are 2 signal lines, then you need to connect the ground wire, clock line, data line with GND、CLK、DATA; if it is 1 signal line, then just need to connect the ground wire, data line with GND、DATA.

Remark: if the V+ voltage of strip is the same with controller input voltage, then it can directly connect with the controller V+; if not, you need to connect another power supply.

Since the specifications of light in the market are different, the sequence of RGB may be different, the sequence of some lights is RGB, some sequence is RBG, GRB and so on, so the DIP switch provides modification of RGB sequence.

DIP switch is shown as below:

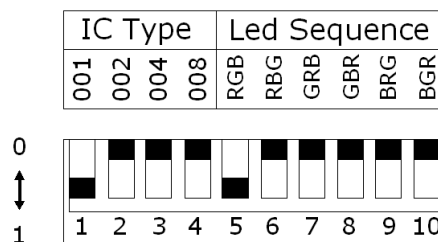

IC type: selection of light type. The accumulation of first four DIP is  $1*1+2*0+4*0+8*0=1$ , lookup the table, you can find it is LPD6803.

LED Sequence: selection of RGB sequence. DIP 5 above is pressed, it indicates that the color sequence of light is RGB.

Remark: if the accumulation of IC type is more than 10, such as 12, 14, the default is 10, that is P9813; when LED sequence, there are two or more DIP are press, such as 5, 7, 9 are pressed simultaneously, default it will take the largest value 9, that is BRG.

2. Indicator description: the signal lights up indicates that it detects button is pressed, the signal is off indicates there is not button pressed.

3. Buttons can only be used when the controller is not connected with DMX signal, when controller is connected with DMX console, the mode of console is priority, and the buttons will not have any effect.

---

**Mode changes are as the following table:**

| Mode | Mode instruction  |
|------|---|
| 1    | Static red  |
| 2    | Static green  |
| 3    | Static blue   |
| 4    | Static yellow   |
| 5    | Static purple   |
| 6    | Static cyan   |
| 7    | Static white  |
| 8    | Red horse race to right   |
| 9    | Green horse race to right   |
| 10   | Blue horse race to right  |
| 11   | Three base color stroboflash  |
| 12   | Seven-color stroboflash   |
| 13   | Three base color jumpy change   |
| 14   | Seven-color jumpy change  |
| 15   | Three mixing color three color wave by wave running forward direction |
| 16   | Seven-color wave forward direction                                    |
| 17   | Red trail forward direction   |
| 18   | Red trail backward direction  |
| 19   | Green trail forward direction   |
| 20   | Green trail backward direction  |
| 21   | Blue trail forward direction  |
| 22   | Blue trail backward direction   |
| 23   | Seven-color running trail backward direction                          |
| 24   | Seven-color running trail forward direction                           |
| 25   | Change color purple-red-purple forward direction                      |
| 26   | Change color yellow-green-yellow forward direction                    |
| 27   | Change color cyan-green-cyan forward direction                        |
| 28   | Change color purple-blue-purple forward direction                     |
| 29   | Change color cyan-blue-cyan forward direction                         |
| 30   | Change color white-red-white forward direction                        |
| 31   | Change color yellow-red-yellow forward direction                      |
| 32   | Change color red-yellow-red   |
| 33   | Change color green-cyan-green   |
| 34   | Change color blue-purple-blue   |
| 35   | Automatically play 8~34   |

**Typical Application**

**Single power connect single signal line strip condition:** if the V+ voltage of strip is the same with controller input voltage, and the light signal is single then it can directly connect with the controller V+;

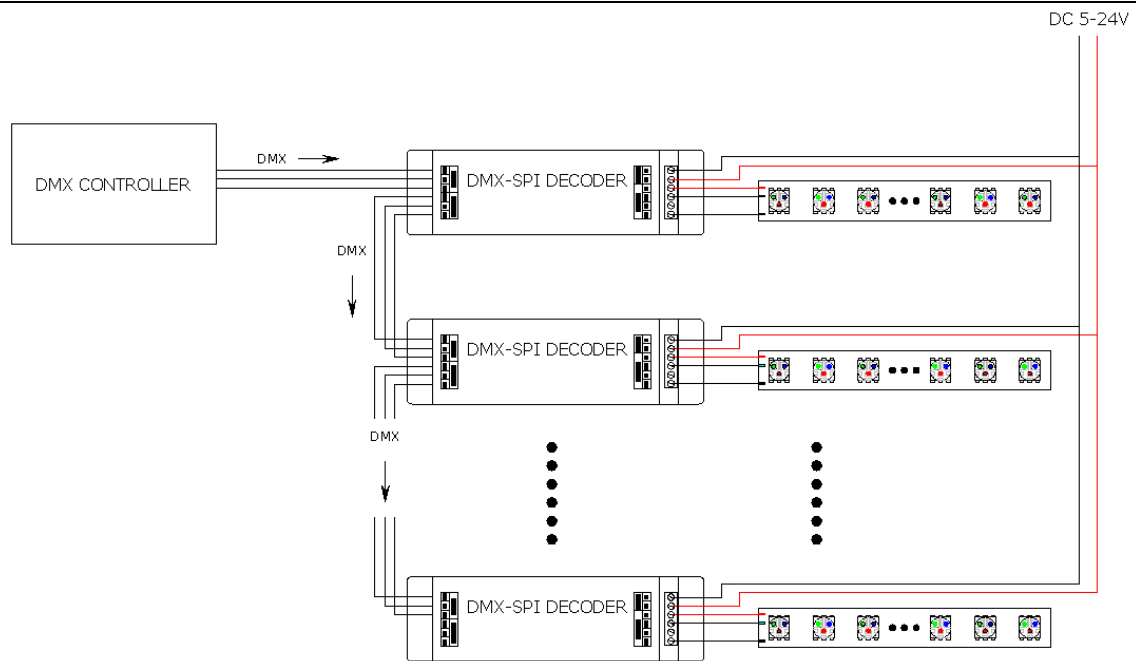

**Single power connect double signal line strip condition:** if the V+ voltage of strip is the same with controller input voltage, and the light signal is double then it can directly connect with the controller V+;

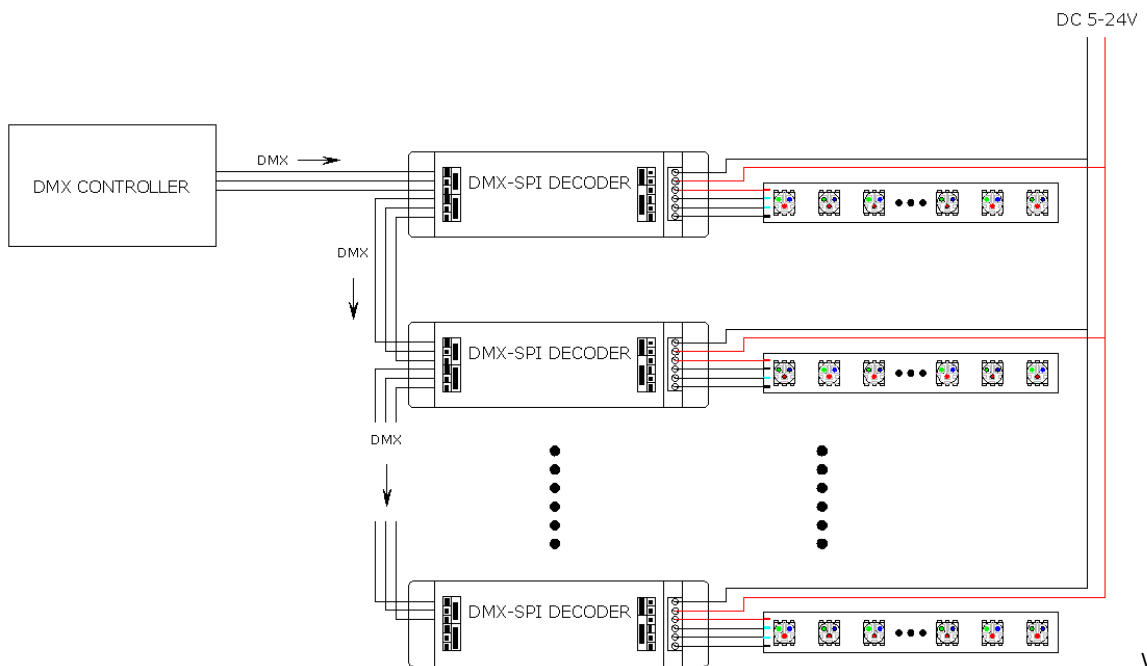

**Double power connect single signal line strip condition:** if the V+ voltage of strip is not the same with controller input voltage and light signal is single, you need to connect another power supply.

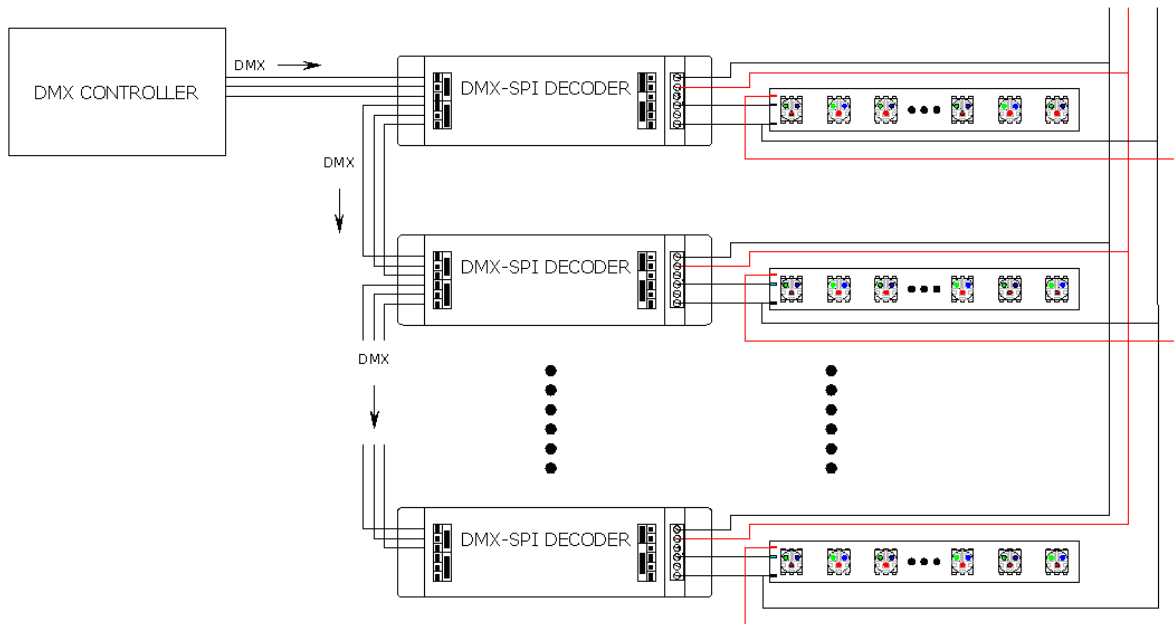

**Double power connect double signal line strip condition:** if the V+ voltage of strip is not the same with controller input voltage and light signal is double, you need to connect another power supply.

